

Current clamps for AC current

MN series



MN SERIES

These ergonomic mini-clamps are designed to make light work of measuring low and medium currents from 0.01 A to 240 A AC.

The shape of the jaws makes 'hooking' onto cables easy, even in areas of restrictive access. The jaws can grip conductors up to 20 mm in diameter.

Depending on the particular model, they have one or two calibres. The output is via either jack sockets or a lead with 4 mm Ø plugs, hence these clamps are compatible with all multimeters and testers on the market.

There are two types of MN series clamps available. The first kind operates as a current transformer (ratio 1,000/1) and gives a current output (mA) for use with any tester with current calibres.

The second type gives a voltage output (DC or AC depending on the model) proportional to the measured current (1, 10, 100 or 1,000 mV/A). This voltage output means that, even with testers without any current calibres, it is possible to measure currents by means of the DC or AC voltage calibres.

There are specific models in the MN series that have been designed with particular applications in mind such as measurement on current transformer outputs, on oscilloscopes and even of leakage currents.

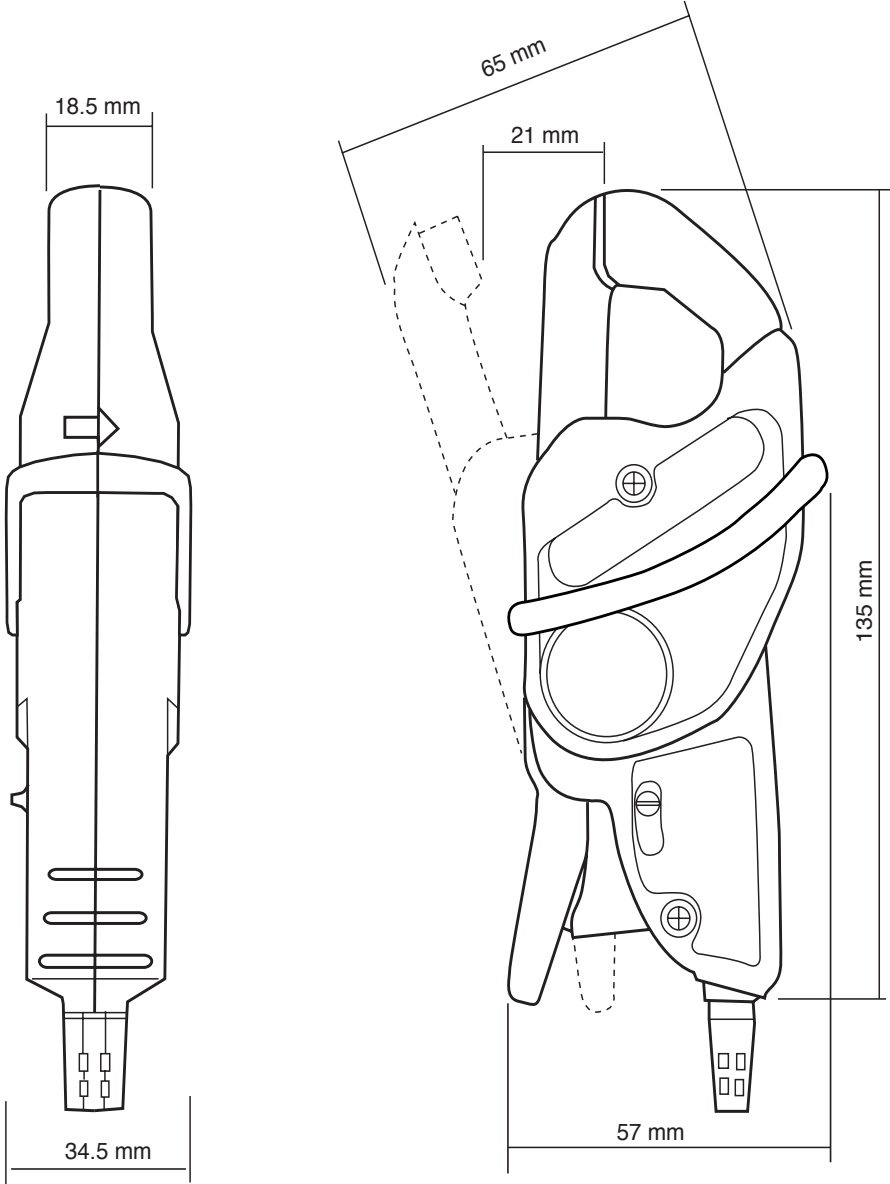

Current clamps for AC current

Models MN08 and MN09

MN series

Current	200 A AC
Ratio	1000/1
Output	1 mA/A

ELECTRICAL SPECIFICATIONS

- **Current range:**
0.5 A AC .. 240 A AC
- **Current transformation ratio:**
1000/1
- **Output signal:**
1 mA AC / A AC (240 mA for 240 A)
- **Accuracy and phase shift ⁽¹⁾:**

Primary current	0.5 A .. 10 A	10 A .. 40 A	40 A .. 100 A	100 A .. 240 A
% Accuracy of output signal	≤ 3 % + 0.5 mA	≤ 2.5 % + 0.5 mA	≤ 2 % + 0.5 mA	≤ 1 % + 0.5 mA
Phase shift	not specified	≤ 5°	≤ 3°	≤ 2.5°

- **Bandwidth:**
40 Hz .. 10 kHz
- **Crest factor:**
3 for a current of 200 A_{RMS}
- **Maximum currents:**
200 A continuous for a frequency ≤ 3 kHz (limitation proportional to the inverse of one third of frequency beyond)
- **Load impedance:**
≤ 10 Ω
- **Operating voltage:**
600 V_{RMS}
- **Common mode voltage:**
600 V category III and pollution degree 2
- **Influence of adjacent conductor:**
≤ 15 mA/A at 50 Hz
- **Influence of conductor position in jaws:**
≤ 0.5 % of output signal at 50/60 Hz
- **Load influence: 0.2 .. 10 Ω**
< 0.5 % on measurement
< 0.5° on phase
- **Influence of frequency ⁽²⁾:**
< 3 % of output signal from 40 Hz .. 1 kHz
< 12 % of output signal from 1 kHz .. 10 kHz
- **Influence of crest factor:**
< 4 % of output signal for a crest factor of 3 and current 200 of A_{RMS}

MECHANICAL SPECIFICATIONS

- **Operating temperature:**
-10 °C to +55 °C
- **Storage temperature:**
-40 °C to +70 °C
- **Influence of temperature:**
≤ 0.15 % of output signal per 10 °K
- **Relative humidity for operation:**
0 to 85 % RH decreasing linearly above 35 °C
- **Influence of relative humidity:**
< 0.2 % of output signal from 10 % to 85 % RH
- **Operating altitude:**
0 to 2,000 m
- **Max. jaw opening:**
20 mm
- **Clamping capacity:**
Cable: Ø max 20 mm
Busbar: 1 busbar of 20 x 5 mm
- **Casing protection rating:**
IP40 (IEC 529)
- **Drop test:**
1 m (IEC 68-2-32)
- **Shock resistance:**
100 g (IEC 68-2-27)
- **Vibration resistance:**
10/55/10 Hz, 0.15 mm (IEC 68-2-6)
- **Self-extinguishing capability:**
Casing: UL94 V2
Jaws: UL94 V0

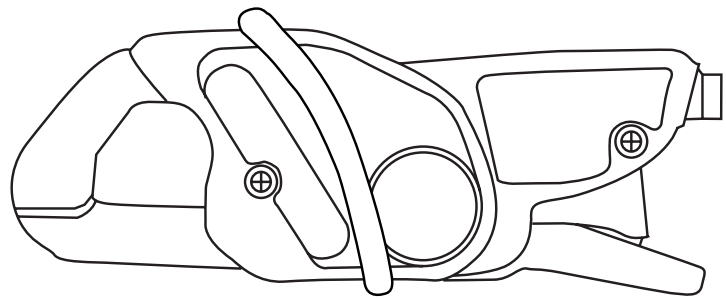

- **Dimensions:**
135 x 51 x 30 mm
- **Weight:**
180 g
- **Colours:**
Dark grey case with red jaws
- **Output:**
MN08:
Safety sockets (4 mm)
MN09:
1.5 m two-wire lead with double or reinforced insulation terminated by 2 elbowed male safety plugs (4 mm)

SAFETY SPECIFICATIONS

- **Electrical safety:**
Instrument with double insulation or reinforced insulation between the primary, the secondary and the grippable part located under the guard as per IEC 1010-1 & IEC 1010-2-032.
- 600 V category III, pollution degree 2
- 300 V category IV, pollution degree 2
- **Electromagnetic compatibility (EMC):**
EN 50081-1: class B
EN 50082-2:
- Electrostatic discharge: IEC 1000-4-2
- Radiated field: IEC 1000-4-3
- Fast transients: IEC 1000-4-4
- Magnetic field at 50/60 Hz: IEC 1000-4-8

(1) Conditions of reference: 23 °C ± 3 °K, 20 to 70 % RH, sinusoidal signal with frequency of 48 Hz to 65 Hz, external magnetic field < 40 A/m, no DC components, no external conductor with circulating current, conductor centred for measurement, 1 Ω load.

(2) Out of reference domain.

To order	Reference
AC current clamp model MN08 with operating manual	P01120401
AC current clamp model MN09 with operating manual	P01120402

Models MN10 and MN11

Current	200 A AC
Ratio	1000/1
Output	1 mA/A

DESCRIPTION

An electronic voltage-limiting system protects output of clamp when operating, if the secondary circuit is opened.

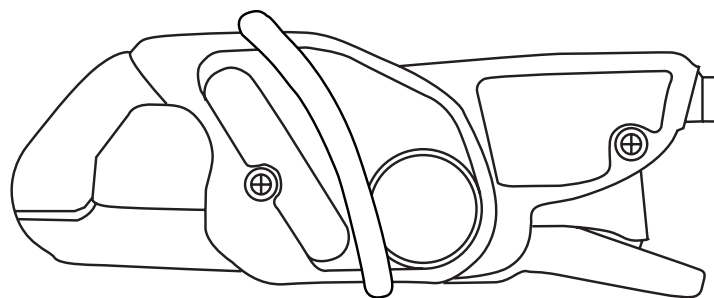

ELECTRICAL SPECIFICATIONS

- Current range:**
0.5 A AC .. 240 A AC
- Current transformation ratio:**
1000/1
- Output signal:**
1 mA AC / A AC (240 mA for 240 A)
- Accuracy and phase shift (1):**

Primary current	0.5 A .. 10 A	10 A .. 40 A	40 A .. 100 A	100 A .. 150 A	150 A .. 200 A	200 A .. 240 A
Accuracy in % of output signal	≤ 3 % + 0.5 mA	≤ 2.5 % + 0.5 mA	≤ 2 % + 0.5 mA	≤ 1 % + 0.5 mA	≤ 2 % + 0.5 mA	≤ 3 % + 0.5 mA
Phase shift	not specified	≤ 5°	≤ 3°	≤ 2.5°	≤ 2.5°	≤ 2.5°

- Bandwidth:**
40 Hz .. 10 kHz
- Crest factor:**
3 for a current of 200 A_{RMS}
- Maximum currents:**
200 A continuous for a frequency ≤ 3 kHz (limitation proportional to the inverse of one third of frequency beyond)
- Load impedance:**
≤ 10 Ω
- Maximum output voltage (secondary open):**
Limited to 8 V peak max.
- Operating voltage:**
600 V_{RMS}
- Common mode voltage:**
600 V category III and pollution degree 2
- Influence of adjacent conductor:**
≤ 15 mA/A at 50 Hz
- Influence of conductor position in jaws:**
≤ 0.5 % of output signal at 50/60 Hz
- Load influence:** 0.2 .. 10 Ω
< 0.5 % on measurement
< 0.5° on phase
- Influence of frequency (2):**
< 3 % of output signal from 40 Hz .. 1 kHz
< 12 % of output signal from 1 kHz .. 10 kHz
- Influence of crest factor:**
< 4 % of output signal for a crest factor of 3 and current of 200 A_{RMS}

MECHANICAL SPECIFICATIONS

- Operating temperature:**
-10 °C to +55 °C
- Storage temperature:**
-40 °C to +70 °C
- Influence of temperature:**
≤ 0.15 % of output signal per 10 °K
- Relative humidity for operation:**
0 to 85 % RH decreasing linearly above 35 °C
- Influence of relative humidity:**
< 0.2 % of output signal from 10 % to 85 % RH
- Operating altitude:**
0 to 2,000 m
- Max. jaw opening:**
20 mm
- Clamping capacity:**
Cable: Ø max 20 mm
Busbar: 1 busbar of 20 x 5 mm
- Casing protection rating:**
IP40 (IEC 529)
- Drop test:**
1 m (IEC 68-2-32)
- Shock resistance:**
100 g (IEC 68-2-27)
- Vibration resistance:**
10/55/10 Hz, 0.15 mm (IEC 68-2-6)
- Self-extinguishing capability:**
Casing: UL94 V2
Jaws: UL94 V0

- Dimensions:**
135 x 51 x 30 mm
- Weight:**
180 g
- Colours:**
Dark grey case with red jaws
- Output:**
MN10:
Safety sockets (4 mm)
MN11:
1.5 m two-wire lead with double or reinforced insulation terminated by 2 elbowed male safety plugs (4 mm)

SAFETY SPECIFICATIONS

- Electrical safety:**
Instrument with double insulation or reinforced insulation between the primary, the secondary and the grippable part located under the guard as per IEC 1010-1 & IEC 1010-2-032
- 600 V category III, pollution degree 2
- 300 V category IV, pollution degree 2
- Electromagnetic compatibility (EMC):**
EN 50081-1: class B
EN 50082-2:
- Electrostatic discharge: IEC 1000-4-2
- Radiated field: IEC 1000-4-3
- Fast transients: IEC 1000-4-4
- Magnetic field at 50/60 Hz: IEC 1000-4-8

(1) Conditions of reference: 23 °C ± 3 °K, 20 to 70 % RH, sinusoidal signal with frequency of 48 Hz to 65 Hz, external magnetic field < 40 A/m, no DC components, no external conductor with circulating current, conductor centred for measurement, 1 Ω load.

(2) Out of reference domain.

To order	Reference
AC current clamp model MN10 with operating manual	P01120403
AC current clamp model MN11 with operating manual	P01120404

Current clamps for AC current

Models MN12 and MN13

MN series

Current	200 A AC
Output	10 mV/A

ELECTRICAL SPECIFICATIONS

- **Current range:**
0.5 A AC .. 240 A AC
- **Output signal:**
10 mV AC / A AC (2.4 V for 240 A)
- **Accuracy and phase shift ⁽¹⁾:**

Primary current	0.5 A .. 10 A	10 A .. 40 A	40 A .. 100 A	100 A .. 240 A
% Accuracy of output signal	≤ 3.5 % + 5 mV	≤ 2.5 % + 5 mV	≤ 2 % + 5 mV	≤ 1 % + 5 mV
Phase shift	not specified	≤ 5°	≤ 3°	≤ 2.5°

- **Bandwidth:**
40 Hz .. 10 kHz
- **Crest factor:**
3 for a current of 200 A_{RMS}
- **Maximum currents:**
200 A continuous for a frequency ≤ 1 kHz (derating proportional to the inverse of frequency beyond)
- **Load impedance:**
> 1 MΩ
- **Operating voltage:**
600 V_{RMS}
- **Common mode voltage:**
600 V category III and pollution degree 2
- **Influence of adjacent conductor:**
≤ 15 mA/A at 50 Hz
- **Influence of conductor position in jaws:**
≤ 0.5 % of output signal at 50/60 Hz
- **Influence of frequency ⁽²⁾:**
< 3 % of output signal from 40 Hz .. 1 kHz
< 12 % of output signal from 1 kHz .. 10 kHz
- **Influence of crest factor:**
< 3 % of output signal for a crest factor of 3 and current of 200 A_{RMS}

MECHANICAL SPECIFICATIONS

- **Operating temperature:**
-10 °C to +55 °C
- **Storage temperature:**
-40 °C to +70 °C
- **Influence of temperature:**
≤ 0.15 % of output signal per 10 °K
- **Relative humidity for operation:**
0 to 85 % RH decreasing linearly above 35 °C
- **Influence of relative humidity:**
< 0.2 % of output signal from 10 % to 85 % RH
- **Operating altitude:**
0 to 2,000 m
- **Max. jaw opening:**
20 mm
- **Clamping capacity:**
Cable: Ø max 20 mm
Busbar: 1 busbar of 20 x 5 mm
- **Casing protection rating:**
IP40 (IEC 529)
- **Drop test:**
1 m (IEC 68-2-32)
- **Shock resistance:**
100 g (IEC 68-2-27)
- **Vibration resistance:**
10/55/10 Hz, 0.15 mm (IEC 68-2-6)
- **Self-extinguishing capability:**
Casing: UL94 V2
Jaws: UL94 V0

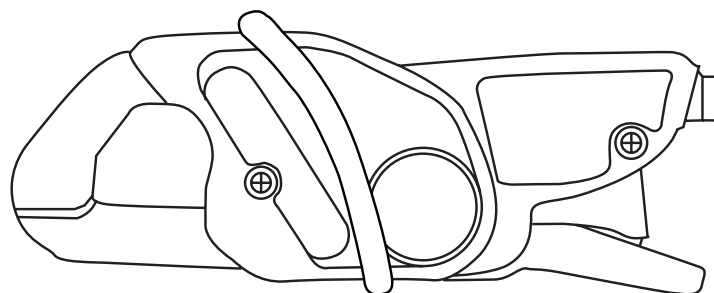

- **Dimensions:**
135 x 51 x 30 mm
- **Weight:**
180 g
- **Colours:**
Dark grey case with red jaws
- **Output:**
MN12:
Safety sockets (4 mm)
MN13:
1.5 m two-wire lead with double or reinforced insulation terminated by 2 elbowed male safety plugs (4 mm)

SAFETY SPECIFICATIONS

- **Electrical safety:**
Instrument with double insulation or reinforced insulation between the primary, the secondary and the grippable part located under the guard as per IEC 1010-1 & IEC 1010-2-032
- 600 V category III, pollution degree 2
- 300 V category IV, pollution degree 2
- **Electromagnetic compatibility (EMC):**
EN 50081-1: class B
EN 50082-2:
- Electrostatic discharge: IEC 1000-4-2
- Radiated field: IEC 1000-4-3
- Fast transients: IEC 1000-4-4
- Magnetic field at 50/60 Hz: IEC 1000-4-8

(1) Conditions of reference: 23 °C ± 3 °K, 20 to 70 % RH, sinusoidal signal with frequency of 48 Hz to 65 Hz, external magnetic field < 40 A/m, no DC components, no external conductor with circulating current, conductor centred for measurement, load impedance > 1 MΩ.

(2) Out of reference domain

To order	Reference
AC current clamp model MN12 with operating manual	P01120405
AC current clamp model MN13 with operating manual	P01120406

Models MN14 and MN15

Current	200 A AC
Output	1 mV/A

ELECTRICAL SPECIFICATIONS

- **Current range:**
0.5 A AC .. 240 A AC
- **Output signal:**
1 mVAC/A AC (240 mV for 240 A)
- **Accuracy and phase shift ⁽¹⁾:**

Primary current	0.5 A .. 10 A	10 A .. 40 A	40 A .. 100 A	100 A .. 240 A
% Accuracy of output signal	≤ 3 % + 5 mV	≤ 2.5 % + 5 mV	≤ 2 % + 5 mV	≤ 1 % + 5 mV
Phase shift	not specified	≤ 5 °	≤ 3 °	≤ 2.5 °

- **Bandwidth:**
40 Hz .. 10 kHz
- **Crest factor:**
3 for a current of 200 A_{RMS}
- **Maximum currents:**
200 A continuous for a frequency ≤ 1 kHz (limitation proportional to the inverse of frequency beyond)
- **Load impedance:**
> 1 MΩ
- **Operating voltage:**
600 V_{RMS}
- **Common mode voltage:**
600 V category III and pollution degree 2
- **Influence of adjacent conductor:**
≤ 15 mA/A at 50/60 Hz
- **Influence of conductor position in jaws:**
≤ 0.5 % of output signal at 50/60 Hz
- **Influence of frequency ⁽²⁾:**
< 3 % of output signal from 40 Hz .. 1 kHz
< 12 % of output signal from 1 kHz .. 10 kHz
- **Influence of crest factor:**
< 3 % of output signal for a crest factor of 3 and current of 200 A_{RMS}

MECHANICAL SPECIFICATIONS

- **Operating temperature:**
-10 °C to +55 °C
- **Storage temperature:**
-40 °C to +70 °C
- **Influence of temperature:**
≤ 0.15 % of output signal per 10 °K
- **Relative humidity for operation:**
0 to 85 % RH decreasing linearly above 35 °C
- **Influence of relative humidity:**
< 0.2 % of output signal of 10 % at 90 % RH
- **Operating altitude:**
0 to 2,000 m
- **Max. jaw opening:**
20 mm
- **Clamping capacity:**
Cable: Ø max 20 mm
Busbar: 1 busbar of 20 x 5 mm
- **Casing protection rating:**
IP40 (IEC 529)
- **Drop test:**
1 m (IEC 68-2-32)
- **Shock resistance:**
100 g (IEC 68-2-27)
- **Vibration resistance:**
10/55/10 Hz, 0.15 mm (IEC 68-2-6)
- **Self-extinguishing capability:**
Casing: UL94 V2
Jaws: UL94 V0

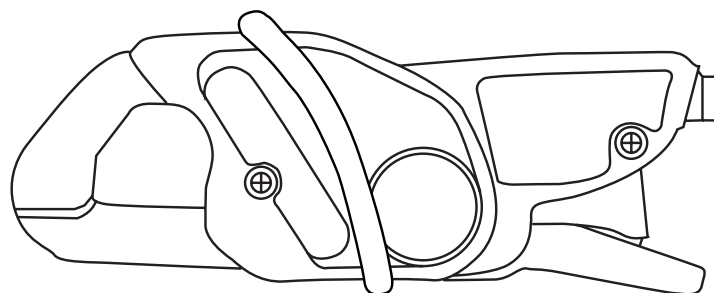

- **Dimensions:**
135 x 51 x 30 mm
- **Weight:**
180 g
- **Colours:**
Dark grey case with red jaws
- **Output:**
MN14:
Safety sockets (4 mm)
MN15:
1.5 m two-wire lead with double or reinforced insulation terminated by 2 elbowed male safety plugs (4 mm)

SAFETY SPECIFICATIONS

- **Electrical safety:**
Instrument with double insulation or reinforced insulation between the primary, the secondary and the grippable part located under the guard as per IEC 1010-1 & IEC 1010-2-032
- 600 V category III, pollution degree 2
- 300 V category IV, pollution degree 2
- **Electromagnetic compatibility (EMC):**
EN 50081-1: class B
EN 50082-2:
- Electrostatic discharge: IEC 1000-4-2
- Radiated field: IEC 1000-4-3
- Fast transients: IEC 1000-4-4
- Magnetic field at 50 Hz: IEC 1000-4-8

(1) Conditions of reference: 23 °C ± 3 °K, 20 to 70 % RH, sinusoidal signal with frequency of 48 Hz to 65 Hz, external magnetic field < 40 A/m, no DC components, no external conductor with circulating current, conductor centred for measurement, load impedance > 1 MΩ.

(2) Out of reference domain

To order	Reference
AC current clamp model MN14 with operating manual	P01120416
AC current clamp model MN15 with operating manual	P01120417

Current clamp for AC current

Model MN21

MN series

Current	200 A AC
Ratio	1000/1
Output	1 mA/A

DESCRIPTION

An electronic voltage-limiting system protects output of clamp when operating, if the secondary circuit is opened.

ELECTRICAL SPECIFICATIONS

- Current range:**
0.1 A AC .. 240 A AC
- Current transformation ratio:**
1000/1
- Output signal:**
1 mA AC / A AC (240 mA for 240 A)
- Accuracy and phase shift ⁽¹⁾:**

Primary current	0.1 A .. 10 A	1 A .. 20 A	20 A .. 80 A	80 A .. 150 A	150 A .. 200 A
% Accuracy of output signal	≤ 2 % + 20 μA	≤ 1 % + 20 μA	≤ 1 %	≤ 2 %	≤ 4 %
Phase shift	not specified	≤ 2°	≤ 1.5°	≤ 1.5°	≤ 2°

- Bandwidth:**
40 Hz .. 10 kHz
- Crest factor:**
5 for a current of 280 A peak
- Maximum currents:**
200 A continuous for a frequency ≤ 3 kHz (limitation proportional to the inverse of one third of frequency beyond)
- Load impedance:**
≤ 10 Ω
- Maximum output voltage (secondary open):**
Limited to 8 V peak max.
- Operating voltage:**
600 V_{RMS}
- Common mode voltage:**
600 V category III and pollution degree 2
- Influence of adjacent conductor:**
≤ 15 mA/A at 50 Hz
- Influence of conductor position in jaws:**
≤ 0.5 % of output signal at 50/60 Hz
- Load influence:** 0.1 .. 5 Ω
< 0.5 % on measurement
< 0.5° on phase
- Influence of frequency $I_p < 150 A$ ⁽²⁾:**
< 5 % of output signal from 40 Hz .. 1 kHz
< 15 % of output signal from 1 kHz .. 10 kHz
add 5 % error if 150 A < I_p < 200 A
- Influence of crest factor:**
< 3 % of output signal for crest factor < 5 with current < 280 A peak (50 A_{RMS})

MECHANICAL SPECIFICATIONS

- Operating temperature:**
-10 °C to +55 °C
- Storage temperature:**
-40 °C to +70 °C
- Influence of temperature:**
≤ 0.20 % of output signal per 10 °K
- Relative humidity for operation:**
0 to 85 % RH decreasing linearly above 35 °C
- Influence of relative humidity:**
< 0.2 % of output signal from 10 % to 85 % RH
- Operating altitude:**
0 to 2,000 m
- Max. jaw opening:**
20 mm
- Clamping capacity:**
Cable: Ø max 20 mm
Busbar: 1 busbar of 20 x 5 mm
- Casing protection rating:**
IP40 (IEC 529)
- Drop test:**
1 m (IEC 68-2-32)
- Shock resistance:**
100 g (IEC 68-2-27)
- Vibration resistance:**
10/55/10 Hz, 0.15 mm (IEC 68-2-6)
- Self-extinguishing capability:**
Casing: UL94 V2
Jaws: UL94 V0

- Dimensions:**
135 x 51 x 30 mm
- Weight:**
180 g
- Colours:**
Dark grey case with red jaws
- Output:**
1.5 m two-wire lead with double or reinforced insulation terminated by 2 elbowed male safety plugs (4 mm)

SAFETY SPECIFICATIONS

- Electrical safety:**
Instrument with double insulation or reinforced insulation between the primary, the secondary and the grippable part located under the guard as per IEC 1010-1 & IEC 1010-2-032
- 600 V category III, pollution degree 2
- 300 V category IV, pollution degree 2
- Electromagnetic compatibility (EMC):**
EN 50081-1: class B
EN 50082-2:
- Electrostatic discharge: IEC 1000-4-2
- Radiated field: IEC 1000-4-3
- Fast transients: IEC 1000-4-4
- Magnetic field at 50 Hz: IEC 1000-4-8

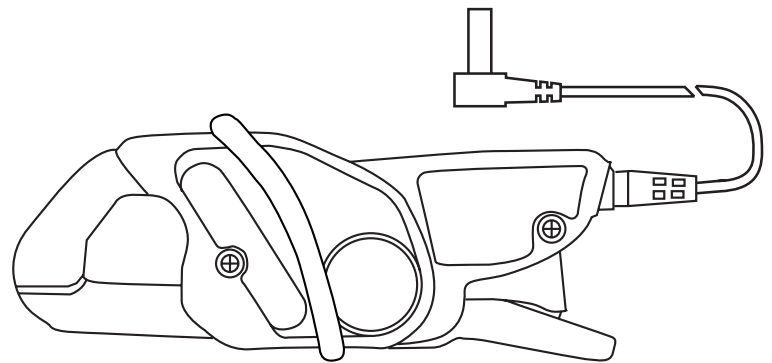

(1) Conditions of reference: 23 °C ± 3 °K, 20 to 70 % RH, sinusoidal signal with frequency of 48 Hz to 65 Hz, external magnetic field < 40 A/m, no DC components, no external conductor with circulating current, conductor centred for measurement, 1 Ω load.

(2) Out of reference domain

To order	Reference
AC current clamp model MN21 with operating manual	P01120418

Current clamp for AC current

Model MN23

MN series

Current	200 A AC
Output	10 mV/A

ELECTRICAL SPECIFICATIONS

- **Current range:**
0.1 A AC .. 240 A AC
- **Output signal:**
10 mVAC/A AC (2.4 V for 240 A)
- **Accuracy and phase shift (1):**

Primary current	0.1 A .. 1 A	1 A .. 20 A	20 A .. 80 A	80 A .. 150 A	150 A .. 200 A
% Accuracy of output signal	≤ 3 % + 200 μA	≤ 2 % + 200 μA	≤ 1 %	≤ 4 %	≤ 10 %
Phase shift	not specified	≤ 3°	≤ 2°	≤ 2.5°	≤ 3.5°

- **Bandwidth:**
40 Hz .. 10 kHz
- **Crest factor:**
5 for a current of 280 A peak
- **Maximum currents:**
200 A continuous for a frequency ≤ 1 kHz (limitation proportional to the inverse of frequency beyond)
- **Load impedance:**
> 1 MΩ
- **Operating voltage:**
600 V_{RMS}
- **Common mode voltage:**
600 V category III and pollution degree 2
- **Influence of adjacent conductor:**
≤ 15 mA/A at 50 Hz
- **Influence of conductor position in jaws:**
≤ 0.5 % of output signal at 50/60 Hz
- **Influence of frequency at IP < 100 A (2):**
< 5 % of output signal from 40 Hz .. 1 kHz**
< 15 % of output signal from 1 kHz .. 10 kHz
**Add 10 % error if 100 < IP < 200 A
- **Influence of crest factor:**
< 3 % of output signal for a crest factor
< 5 to a current < 280 A peak (50 A_{RMS})

MECHANICAL SPECIFICATIONS

- **Operating temperature:**
-10 °C to +55 °C
- **Storage temperature:**
-40 °C to +70 °C
- **Influence of temperature:**
≤ 0.20 % of output signal per 10 °K
- **Relative humidity for operation:**
0 to 85 % RH decreasing linearly above 35 °C
- **Influence of relative humidity:**
< 0.2 % of output signal from 10 % to 85 % RH
- **Operating altitude:**
0 to 2,000 m
- **Max. jaw opening:**
20 mm
- **Clamping capacity:**
Cable: Ø max 20 mm
Busbar: 1 busbar of 20 x 5 mm
- **Casing protection rating:**
IP40 (IEC 529)
- **Drop test:**
1 m (IEC 68-2-32)
- **Shock resistance:**
100 g (IEC 68-2-27)
- **Vibration resistance:**
10/55/10 Hz, 0.15 mm (IEC 68-2-6)

- **Self-extinguishing capability:**
Casing: UL94 V2
Jaws: UL94 V0
- **Dimensions:**
135 x 51 x 30 mm
- **Weight:**
180 g
- **Colours:**
Dark grey case with red jaws
- **Output:**
1.5 m two-wire lead with double or reinforced insulation terminated by 2 elbowed male safety plugs (4 mm)

SAFETY SPECIFICATIONS

- **Electrical safety:**
Instrument with double insulation or reinforced insulation between the primary, the secondary and the grippable part located under the guard as per IEC 1010-1 & IEC 1010-2-032
- 606.5 V category III, pollution degree 2
- 306.5 V category IV, pollution degree 2
- **Electromagnetic compatibility (EMC):**
EN 50081-1: class B
EN 50082-2:
- Electrostatic discharge: IEC 1000-4-2
- Radiated field: IEC 1000-4-3
- Fast transients: IEC 1000-4-4
- Magnetic field at 50 Hz: IEC 1000-4-8

(1) Conditions of reference: 23 °C ± 3 °K, 20 to 70 % RH, sinusoidal signal with frequency of 48 Hz to 65 Hz, external magnetic field < 40 A/m, no DC components, no external conductor with circulating current, conductor centred for measurement, load impedance > 1 MΩ.

(2) Out of reference domain.

To order	Reference
AC current clamp model MN23 with operating manual	P01120419

Current clamps for AC current

Models MN38 and MN39

MN series

Current	20 A AC	200 A AC
Output	100 mV/A	10 mV/A

ELECTRICAL SPECIFICATIONS

- Current range:**
0.1 A AC .. 24 A AC
0.5 A AC .. 240 A AC
- Output signal:**
100 mV AC / A AC (2.4 V for 24 A)
10 mV AC / A AC (2.4 V for 240 A)
- Accuracy and phase shift ⁽¹⁾:**

Calibre	20 A		200 A		
	0.1 A .. 20 A	0.5 A .. 10 A	10 A .. 40 A	40 A .. 100 A	100 A .. 240 A
Primary current	0.1 A .. 20 A	0.5 A .. 10 A	10 A .. 40 A	40 A .. 100 A	100 A .. 240 A
% Accuracy of output signal	≤ 1% + 50 mV	≤ 3% + 5 mV	≤ 2.5% + 5 mV	≤ 2% + 5 mV	≤ 1% + 5 mV
Phase shift	not specified	not specified	≤ 5°	≤ 3°	≤ 2.5°

- Bandwidth:**
40 Hz .. 10 kHz
- Crest factor:**
3 for a current of 200 A_{RMS}
- Maximum currents:**
200 A continuous for a frequency ≤ 1 kHz (limitation proportional to the inverse of frequency beyond)
- Load impedance:**
> 1 MΩ
- Operating voltage:**
600 V_{RMS}
- Common mode voltage:**
600 V category III and pollution degree 2
- Influence of adjacent conductor:**
≤ 15 mA/A at 50 Hz
- Influence of conductor position in jaws:**
≤ 0.5 % of output signal at 50/60 Hz
- Influence of frequency ⁽²⁾:**
 - 20 A calibre:
< 5 % of output signal from 40 Hz .. 1 kHz
< 15 % of output signal from 1 kHz .. 10 kHz
 - 200 A calibre:
< 3 % of output signal from 40 Hz .. 1 kHz
< 12 % of output signal from 1 kHz .. 10 kHz
- Influence of crest factor:**
< 3 % of output signal for a crest factor of 3 and current of 200 A_{RMS}

MECHANICAL SPECIFICATIONS

- Operating temperature:**
-10 °C to +55 °C
- Storage temperature:**
-40 °C to +70 °C
- Influence of temperature:**
≤ 0.15 % of output signal per 10 °K
- Relative humidity for operation:**
0 to 85 % RH decreasing linearly above 35 °C
- Influence of relative humidity:**
< 0.2 % of output signal from 10 % to 85 % RH
- Operating altitude:**
0 to 2,000 m
- Max. jaw opening:**
20 mm
- Clamping capacity:**
Cable: Ø max 20 mm
Busbar: 1 busbar of 20 mm x 5 mm
- Casing protection rating:**
IP40 (IEC 529)
- Drop test:**
1 m (IEC 68-2-32)
- Shock resistance:**
100 g (IEC 68-2-27)
- Vibration resistance:**
10/55/10 Hz, 0.15 mm (IEC 68-2-6)
- Self-extinguishing capability:**
Casing: UL94 V2
Jaws: UL94 V0

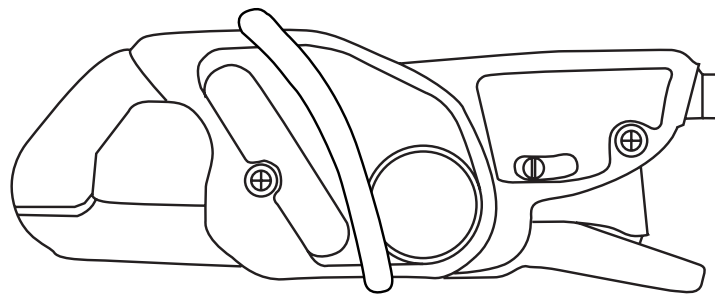

- Dimensions:**
135 x 51 x 30 mm
- Weight:**
180 g
- Colours:**
Dark grey case with red jaws
- Output:**
MN38:
Safety jacks (4 mm)
MN39:
1.5 m two-wire lead with double or reinforced insulation terminated by 2 elbowed male safety plugs (4 mm)

SAFETY SPECIFICATIONS

- Electrical safety:**
Instrument with double insulation or reinforced insulation between the primary the secondary and the grippable part located under the guard as per IEC 1010-1 & IEC 1010-2-032
- 600 V category III, pollution degree 2
- 300 V category IV, pollution degree 2
- Electromagnetic compatibility (EMC):**
EN 50081-1: class B
EN 50082-2:
- Electrostatic discharge: IEC 1000-4-2
- Radiated field: IEC 1000-4-3
- Fast transients: IEC 1000-4-4
- Magnetic field at 50/60 Hz: IEC 1000-4-8

(1) Conditions of reference: 23 °C ± 3 °K, 20 to 70 % RH, sinusoidal signal with frequency of 48 Hz to 65 Hz, external magnetic field < 40 A/m, no DC components, no external conductor with circulating current, conductor centred for measurement, load impedance > 1 MΩ.

(2) Out of reference domain

To order	Reference
AC current clamp model MN38 with operating manual	P01120407
AC current clamp model MN39 with operating manual	P01120408

Model MN60 (insulated AC current probe)

Current	60 A peak	600 A peak
Output	100 mV/A	10 mV/A

DESCRIPTION

This 200 A AC clamp enables easy display and measurement of "current" curves. It fits any oscilloscope since it has a coaxial lead with BNC plug. It produces a mV signal directly proportional to current. It offers 2 different sensitivities.

ELECTRICAL SPECIFICATIONS

- Current range:**
0.1 A AC .. 20 A AC (60 A peak)
0.5 A AC .. 200 A AC (600 A peak)
- Output signal:**
100 mV AC / A AC (2 V for 20 A)
10 mV AC / A AC (2 V for 200 A)

- Accuracy and phase shift ⁽¹⁾:**

Calibre	20 A	200 A			
Primary current	0.1 A .. 20 A	0.5 A .. 10 A	10 A .. 40 A	40 A .. 100 A	100 A .. 240 A
% Accuracy of output signal	≤ 2% + 50 mV	≤ 3.5% + 5 mV	≤ 3% + 5 mV	≤ 2.5% + 5 mV	≤ 1.5% + 5 mV
Phase shift	not specified	not specified	≤ 6°	≤ 4°	≤ 3°

- Bandwidth:**
40 Hz .. 40 kHz (-3 dB) (depending on current value)
- Rise/fall time from 10 % to 90 %:**
 - 20 A calibre: 7.4 μs
 - 200 A calibre: 8.7 μs
- 10 % delay time:**
0.1 μs
- Ampere second product:**
 - 20 A calibre: 25 A.s
 - 200 A calibre: 2 A.s
- Insertion impedance (at 400 Hz / 10 kHz)**
 - 20 A calibre: < 0.3 mΩ / < 7.2 mΩ
 - 200 A calibre: < 1 mΩ / < 26 mΩ
- Maximum currents:**
200 A continuous for a frequency ≤ 3 kHz (limitation proportional to inverse of one third of frequency beyond)
- Influence of temperature:**
≤ 150 ppm / k or 0.15% of output signal per 10 °K
- Influence of relative humidity:**
< 0.2% of output signal
- Influence of adjacent conductor:**
≤ 15 mA/A at 50 Hz
- Influence of DC current < 10 % of rated calibre superimposed on the rated current:**
 - 20 A calibre:
For I DC < 2 A: influence < 0.5 %
 - 200 A calibre:
For I DC < 20 A: influence < 5 %
- Influence of conductor position in jaws:**
≤ 0.5 % of output signal at 50/60 Hz

- Influence of frequency ⁽²⁾:**
 - 20 A calibre:
< 10 % of output signal from 40 Hz .. 1 kHz
< 15 % of output signal from 1 kHz .. 10 kHz
 - 200 A calibre:
< 3 % of output signal from 40 Hz .. 1 kHz
< 12 % of output signal from 1 kHz .. 10 kHz
- Influence of crest factor:**
< 3 % of output signal for a crest factor of 3 and current of 200 A_{RMS}

MECHANICAL SPECIFICATIONS

- Operating temperature:**
-10 °C to +55 °C
- Storage temperature:**
-40 °C to +70 °C
- Relative humidity for operation:**
0 to 85 % RH decreasing linearly above 35 °C
- Operating altitude:**
0 to 2,000 m
- Max. jaw opening:**
20 mm
- Clamping capacity:**
Cable: Ø max 20 mm
Busbar: 1 busbar of 20 x 5 mm
- Casing protection rating:**
IP40 (IEC 529)
- Drop test:**
1 m (IEC 68-2-32)
- Shock resistance:**
100 g / 6 ms / half-periode (IEC 68-2-27)

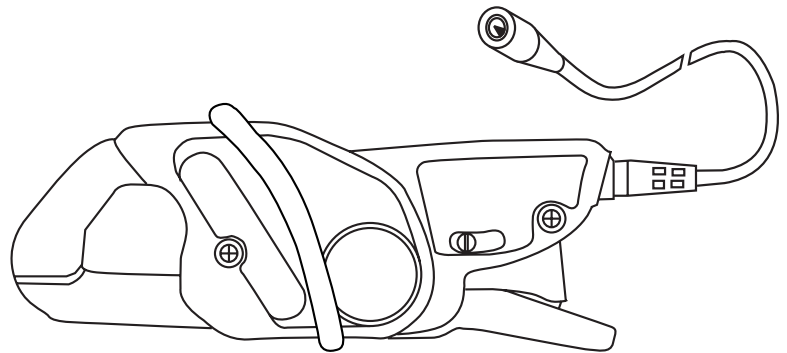

- Protection against impacts:**
IK04 0.5 J (EN 50102)
- Vibration resistance:**
10/55/10 Hz, 0.15 mm (IEC 68-2-6)
- Self-extinguishing capability:**
Casing: UL94 V2
Jaws: UL94 V0
- Dimensions:**
128 x 49 x 28 mm
- Weight:**
180 g
- Colours:**
Dark grey case with red jaws
- Output:**
Coaxial cable 2 m long, terminated by an insulated BNC connector

SAFETY SPECIFICATIONS

- Electrical safety:**
Instrument with double insulation or reinforced insulation between the primary, the secondary and the grippable part located under the guard as per IEC 1010-1 & IEC 1010-2-032
- 600 V category III, pollution degree 2
- 300 V category IV, pollution degree 2
- Electromagnetic compatibility (EMC):**
EN 50081-1: class B
EN 50082-2:
- Electrostatic discharge: IEC 1000-4-2
4 kV level 2 performance criterion B
8 kV in the air level 3 performance criterion B
- Radiated field: IEC 1000-4-3
10 V/m performance criterion A
- Fast transients: IEC 1000-4-4
1 kV level 2 performance criterion B
2 kV level 3 performance criterion B
- Magnetic field at 50/60 Hz: IEC 1000-4-8
field of 400 A/m at 50 Hz: < 1 A

CURVES AT 50 Hz

200 A calibre

20 A calibre

Error on measurement

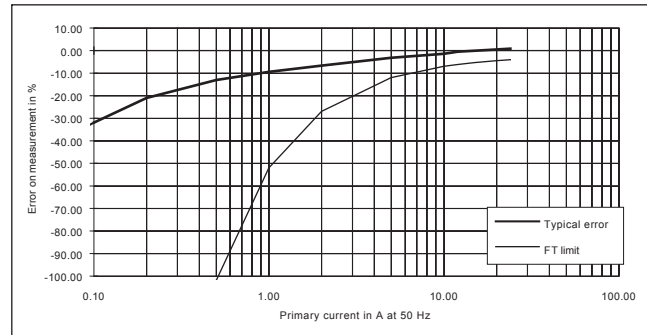
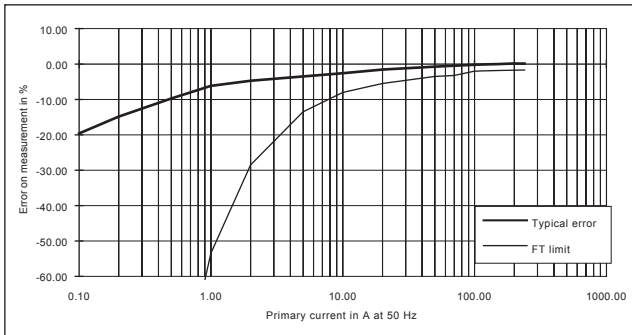

Phase shift

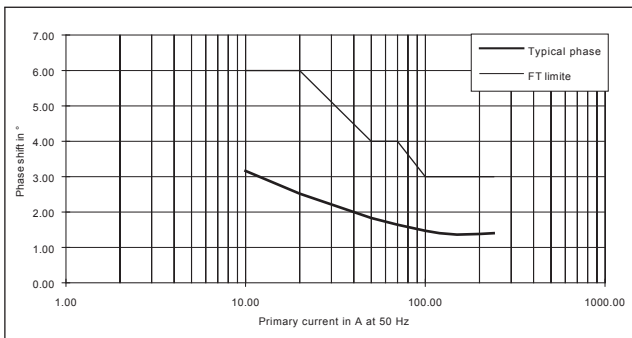

FREQUENCY RESPONSE

200 A calibre

20 A calibre

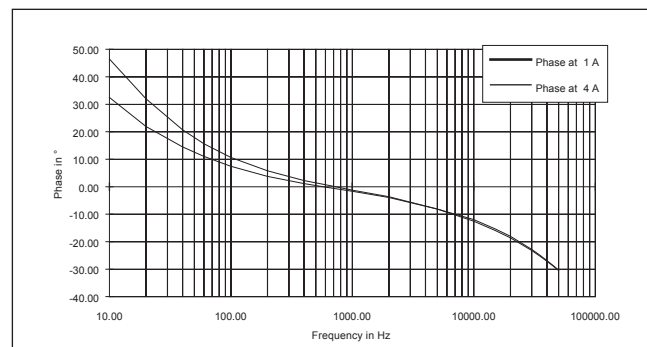
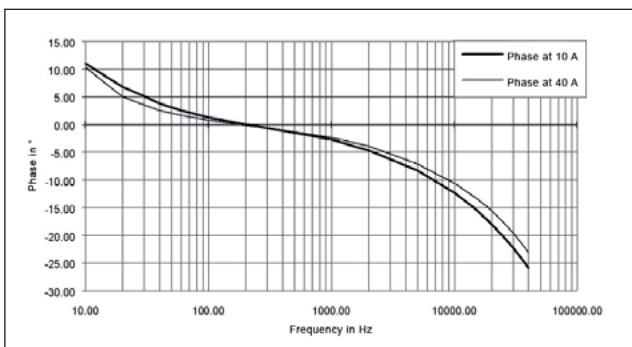
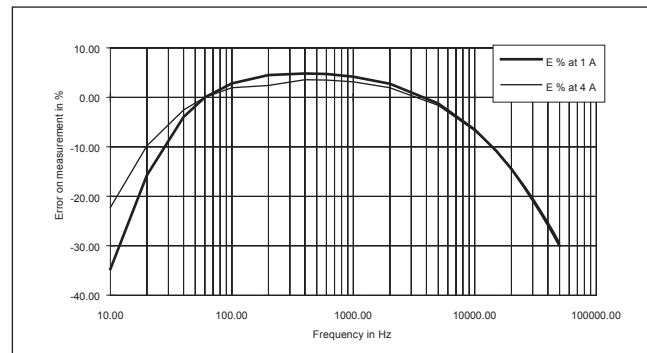
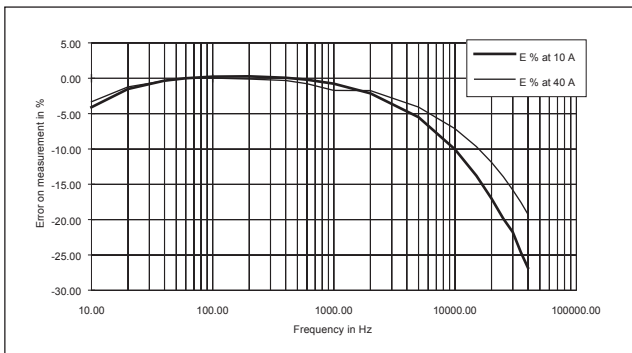

FREQUENCY RESPONSE (CONT.)

200 A calibre

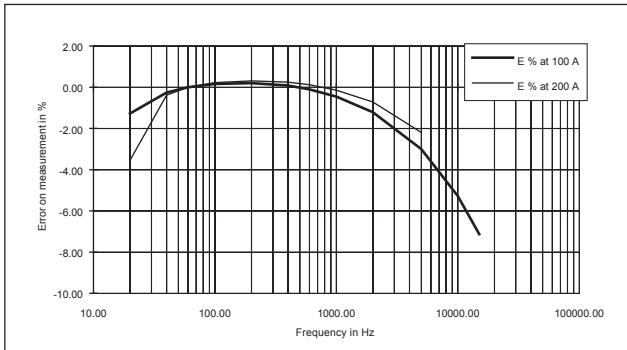

20 A calibre

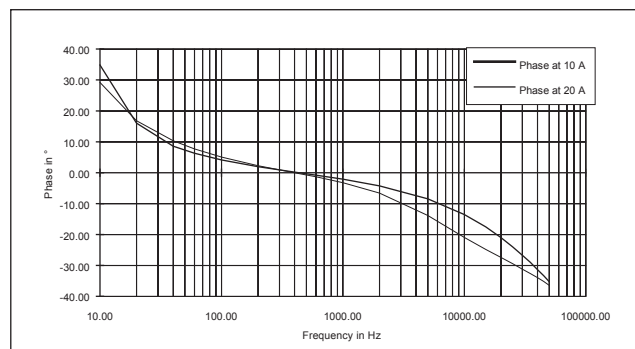
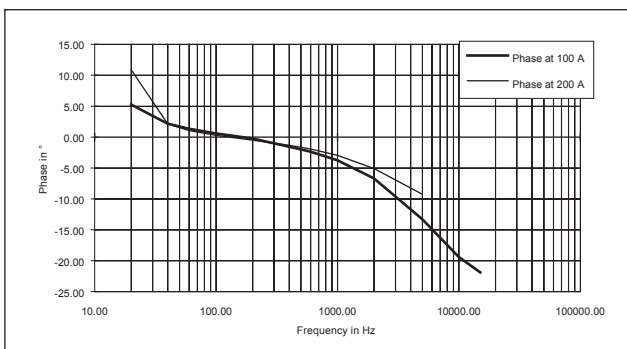
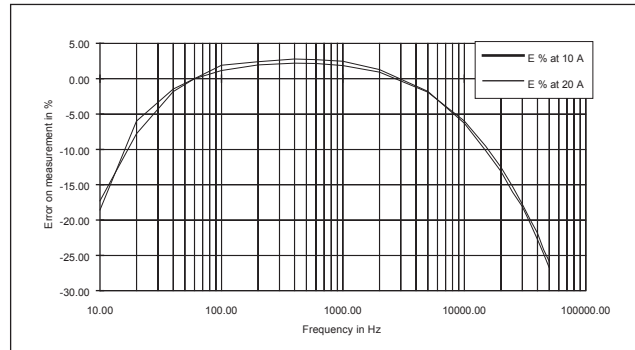

RESPONSE TO A SQUARE SIGNAL

200 A calibre

20 A calibre

10 A at 10 Hz

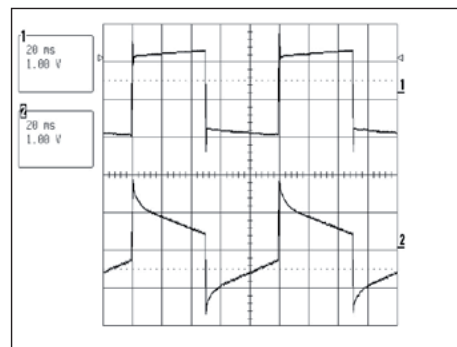
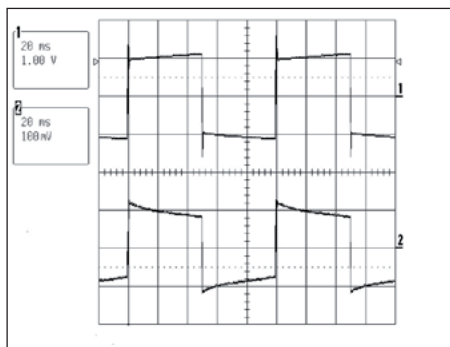

10 A at 100 Hz

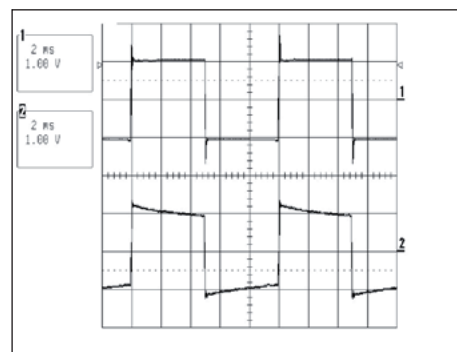
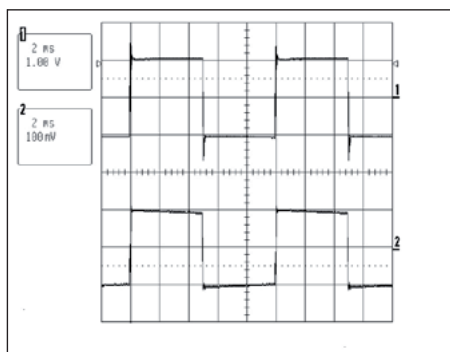

RESPONSE TO A SQUARE SIGNAL (CONT.)

200 A calibre

20 A calibre

10 A at 1 kHz

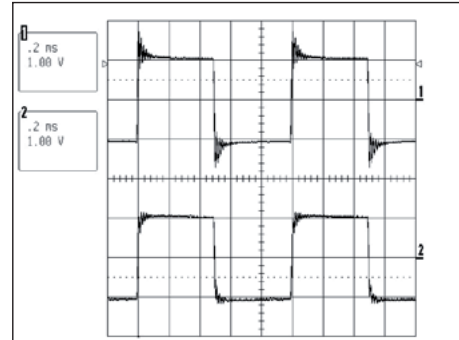
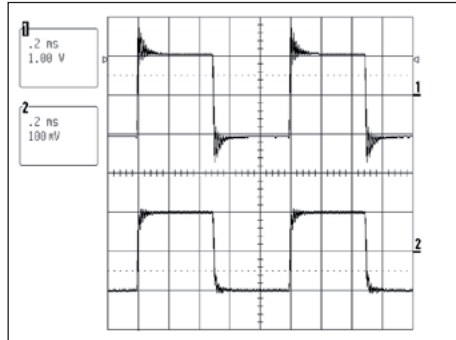

10 A at 10 kHz

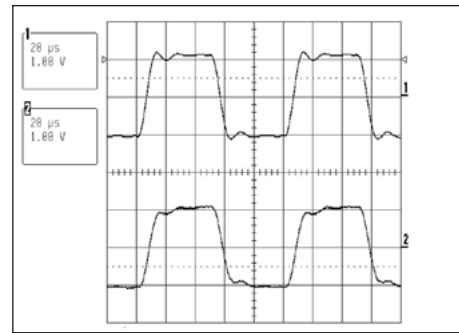
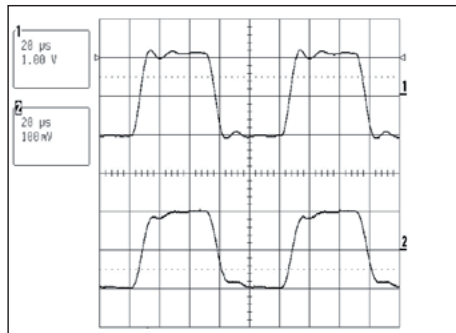

(1) Conditions of reference: 23 °C ± 3 °K, 20 % to 75 % RH, sinusoidal signal with frequency of 48 Hz at 1 kHz, external magnetic field < 40 A/m, no DC components, no external conductor with circulating current, conductor centred for measurement, load impedance > 1 MΩ and < 100 pF.
 (2) Out of reference domain

To order	Reference
AC current clamp model MN60 for oscilloscope with operating manual	P01120409

Model MN71

Current	10 A AC
Output	100 mV/A

DESCRIPTION

This clamp was specially designed to measure current on current transformer secondary circuits.

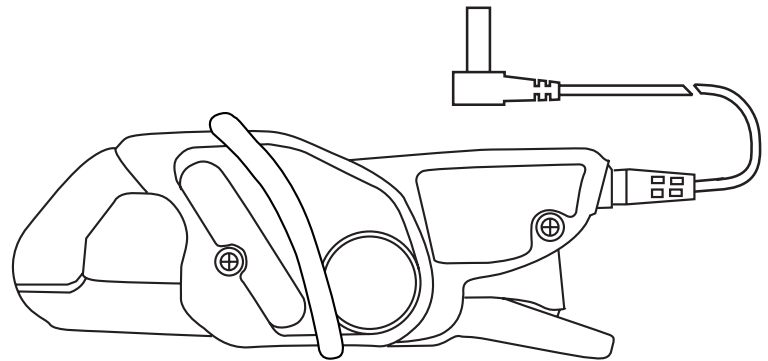

ELECTRICAL SPECIFICATIONS

- **Current range:**
0.01 A AC .. 12 A AC
- **Output signal:**
100 mVAC/A AC (1.2 V for 12 A)
- **Accuracy and phase shift ⁽¹⁾:**

Primary current	0.01 A .. 0.1 A	0.1 A .. 1 A	1 A .. 5 A	5 A .. 12 A
Accuracy in % of output signal	≤ 3 % + 0.1 mV	≤ 2.5 %	≤ 1 %	
Phase shift	not specified	≤ 5°	≤ 3°	≤ 3°

- **Bandwidth:**
40 Hz .. 10 kHz
- **Crest factor:**
5 for a current of 40 A peak (8 A_{RMS})
- **Maximum currents:**
20 A continuous for a frequency ≤ 10 kHz (limitation proportional to the inverse of one tenth of frequency beyond)
- **Load impedance:**
> 1 MΩ
- **Operating voltage:**
600 V_{RMS}
- **Common mode voltage:**
600 V category III and pollution degree 2
- **Influence of adjacent conductor:**
< 15 mA/A at 50 Hz
- **Influence of conductor position in jaws:**
< 0.5 % of output signal at 50/60 Hz
- **Influence of frequency ⁽²⁾:**
< 5 % of output signal from 20 Hz .. 1 kHz
< 10 % of output signal from 1 kHz .. 10 kHz
- **Influence of crest factor:**
< 3 % of output signal for crest factor < 5 with current < 40 A_{RMS}

MECHANICAL SPECIFICATIONS

- **Operating temperature:**
-10 °C to +55 °C
- **Storage temperature:**
-40 °C to +70 °C
- **Influence of temperature:**
≤ 0.2 % of output signal per 10 °K
- **Relative humidity for operation:**
0 to 85 % RH decreasing linearly above 35 °C
- **Influence of relative humidity:**
< 0.2 % of output signal from 10 % to 85 % RH
- **Operating altitude:**
0 to 2,000 m
- **Max. jaw opening:**
20 mm
- **Clamping capacity:**
Cable: Ø max 20 mm
Busbar: 1 busbar of 20 x 5 mm
- **Casing protection rating:**
IP40 (IEC 529)
- **Drop test:**
1 m (IEC 68-2-32)
- **Shock resistance:**
100 g (IEC 68-2-27)
- **Vibration resistance:**
10/55/10 Hz, 0.15 mm (IEC 68-2-6)

- **Self-extinguishing capability:**
Casing: UL94 V2
Jaws: UL94 V0
- **Dimensions:**
135 x 51 x 30 mm
- **Weight:**
180 g
- **Colours:**
Dark grey case with red jaws
- **Output:**
1.5 m two-wire lead with double or reinforced insulation terminated by 2 elbowed male safety plugs (4 mm)

SAFETY SPECIFICATIONS:

- **Electrical safety:**
Instrument with double insulation or reinforced insulation between the primary the secondary and the grippable part located under the guard as per IEC 1010-1 & IEC 1010-2-032
- 600 V category III, pollution degree 2
- 300 V category IV, pollution degree 2
- **Electromagnetic compatibility (EMC):**
EN 50081-1: class B
EN 50082-2:
- Electrostatic discharge: IEC 1000-4-2
- Radiated field: IEC 1000-4-3
- Fast transients: IEC 1000-4-4
- Magnetic field at 50 Hz: IEC 1000-4-8

(1) Conditions of reference: 23 °C ± 3 °K, 20 % to 75 % RH, sinusoidal signal with frequency of 48 Hz to 65 Hz, external magnetic field < 40 A/m, no DC components, no external conductor with circulating current, conductor centred for measurement, load impedance > 1 MΩ.

(2) Out of reference domain

To order	Reference
AC current clamp model MN71 with operating manual	P01120420

Model MN73

Current	2 A AC	200 A AC
Output	1,000 mV/A	10 mV/A

DESCRIPTION

This clamp has a wide measurement range (up to 200 A), and it can also measure very low currents. We call it the "universal" probe.

ELECTRICAL SPECIFICATIONS

- **Current calibres:**
0.01 A AC .. 2.4 A AC
0.1 A AC .. 240 A AC
- **Output signal:**
1,000 mV AC / A AC (2 V for 2 A)
10 mV AC / A AC (2.4 V for 240 A)
- **Accuracy and phase shift ⁽¹⁾:**

Calibre	2 A				200 A				
	0.01 A .. 0.1 A	0.1 A .. 1 A	1 A .. 2 A	2 A .. 2.4 A	0.1 A .. 1 A	1 A .. 20 A	20 A .. 80 A	80 A .. 150 A	150 A .. 200 A
Primary current									
% Accuracy of output signal	≤ 5 % + 2 mV	≤ 3 % + 1 mV	≤ 1 %	≤ 1 %	≤ 3 % + 200 μV	≤ 2 % + 200 μV	≤ 1 %	≤ 4 %	≤ 10 %
Phase shift	not specified				not specified	≤ 3°	≤ 2°	≤ 3°	≤ 4°

- **Bandwidth:**
40 Hz .. 10 kHz
- **Crest factor:**
5 for a current of 280 A peak (200 A_{RMS})
- **Maximum currents:**
200 A continuous for a frequency ≤ 1 kHz (limitation proportional to the inverse frequency beyond)
- **Load impedance:**
> 1 MΩ
- **Operating voltage:**
600 V_{RMS}
- **Common mode voltage:**
600 V category III and pollution degree 2
- **Influence of adjacent conductor:**
≤ 15 mA/A at 50 Hz
- **Influence of conductor position in jaws:**
≤ 0.5 % of output signal at 50/60 Hz
- **Influence of frequency ⁽²⁾:**
 - Calibre 2 A:
< 10 % of output signal from 40 Hz .. 10 kHz
 - 200 A calibre:
< 5 % of output signal from 40 Hz .. 1 kHz**
< 15 % of output signal from 1 kHz .. 10 kHz
** add 10 % error if 100 A < I_{primary} < 200 A
- **Influence of crest factor:**
< 5 % of output signal for crest factor < 5 with current < 280 A_{RMS}

MECHANICAL SPECIFICATIONS

- **Operating temperature:**
-10 °C to +55 °C
- **Storage temperature:**
-40 °C to +70 °C
- **Influence of temperature:**
≤ 0.20 % of output signal per 10 °K
- **Relative humidity for operation:**
0 to 85 % RH decreasing linearly above 35 °C
- **Influence of relative humidity:**
< 0.2 % of output signal from 10 % to 85 % RH
- **Operating altitude:**
0 to 2,000 m
- **Max. jaw opening:**
20 mm
- **Clamping capacity:**
Cable: Ø max 20 mm
Busbar: 1 busbar of 20 x 5 mm
- **Casing protection rating:**
IP40 (IEC 529)
- **Drop test:**
1 m (IEC 68-2-32)
- **Shock resistance:**
100 g (IEC 68-2-27)
- **Vibration resistance:**
10/55/10 Hz, 0.15 mm (IEC 68-2-6)

- **Self-extinguishing capability:**
Casing: UL94 V2
Jaws: UL94 V0
- **Dimensions:**
135 x 51 x 30 mm
- **Weight:**
180 g
- **Colours:**
Dark grey case with red jaws
- **Output:**
1.5 m two-wire lead with double or reinforced insulation terminated by 2 elbowed male safety plugs (4 mm)

SAFETY SPECIFICATIONS

- **Electrical safety:**
Instrument with double insulation or reinforced insulation between the primary the secondary and the grippable part located under the guard as per IEC 1010-1 & IEC 1010-2-032
- 600 V category III, pollution degree 2
- 300 V category IV, pollution degree 2
- **Electromagnetic compatibility (EMC):**
EN 50081-1: class B
EN 50082-2:
- Electrostatic discharge: IEC 1000-4-2
- Radiated field: IEC 1000-4-3
- Fast transients: IEC 1000-4-4
- Magnetic field at 50 Hz: IEC 1000-4-8

(1) Conditions of reference: 23 °C ± 3 °K, 20 % to 75 % RH, sinusoidal signal with frequency of 48 Hz to 65 Hz, external magnetic field < 40 A/m, no DC components, no external conductor with circulating current, conductor centred for measurement, load impedance > 1 MΩ.

(2) Out of reference domain

To order	Reference
AC current clamp model MN73 with operating manual	P01120421
Accessory: AN1 artificial neutral box (see chapter 12)	P01197201

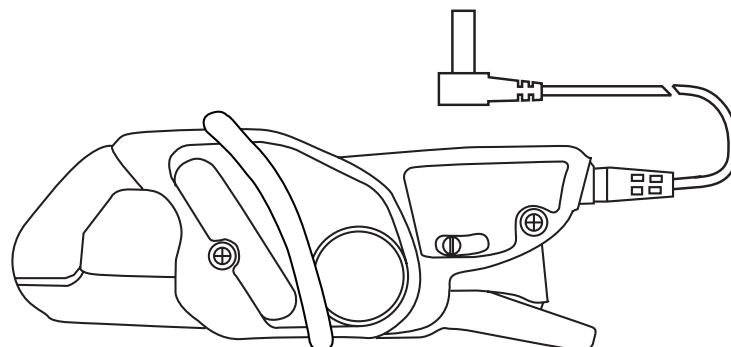

Models MN88 and MN89

Current	200 A AC
Output	100 mV DC/A

DESCRIPTION

These clamps produce a DC voltage output which is very useful for multimeters whose sensitivity in V or A is too weak.

ELECTRICAL SPECIFICATIONS

- **Current range:**
0.5 A AC .. 240 A AC
- **Output signal:**
100 mV DC/A (24 V for 240 A AC)
- **Accuracy ⁽¹⁾:**

Primary current	0.5 A .. 10 A	10 A .. 40 A	40 A .. 100 A	100 A .. 240 A
% Accuracy of output signal	≤ 5 % + 50 mV	≤ 3 % + 50 mV	≤ 2 % + 50 mV	≤ 2 %

- **Bandwidth:**
40 Hz .. 10 kHz
- **Crest factor:**
3 for a current of 200 A_{RMS}
- **Maximum currents:**
200 A continuous for a frequency ≤ 1 kHz (derating proportional to the inverse of frequency beyond)
- **Load impedance:**
> (1 MΩ + filter RC 2s)
- **Operating voltage:**
600 V_{RMS}
- **Common mode voltage:**
600 V category III and pollution degree 2
- **Influence of adjacent conductor:**
≤ 15 mA / A at 50 Hz
- **Influence of conductor position in jaws:**
≤ 0.5 % of output signal at 50 Hz
- **Influence of frequency ⁽²⁾:**
< 5 % of output signal from 40 Hz .. 1 kHz < 12 % of output signal from 1 kHz .. 10 kHz
- **Influence of crest factor**
< 3 % of output signal for a crest factor of 3 and current of 200 A_{RMS}

MECHANICAL SPECIFICATIONS

- **Operating temperature:**
-10 °C to +55 °C
- **Storage temperature:**
-40 °C to +70 °C
- **Influence of temperature:**
≤ 0.15 % of output signal per 10 °K
- **Relative humidity for operation:**
0 to 85 % RH decreasing linearly above 35 °C
- **Influence of relative humidity:**
< 0.2 % of output signal from 10 % to 85 % RH
- **Operating altitude:**
0 to 2,000 m
- **Max. jaw opening:**
20 mm
- **Clamping capacity:**
Cable: Ø max 20 mm
Busbar: 1 busbar of 20 x 5 mm
- **Casing protection rating:**
IP40 (IEC 529)
- **Drop test:**
1 m (IEC 68-2-32)
- **Shock resistance:**
100 g (IEC 68-2-27)
- **Vibration resistance:**
10/55/10 Hz, 0.15 mm (IEC 68-2-6)
- **Self-extinguishing capability:**
Casing: UL94 V2
Jaws: UL94 V0

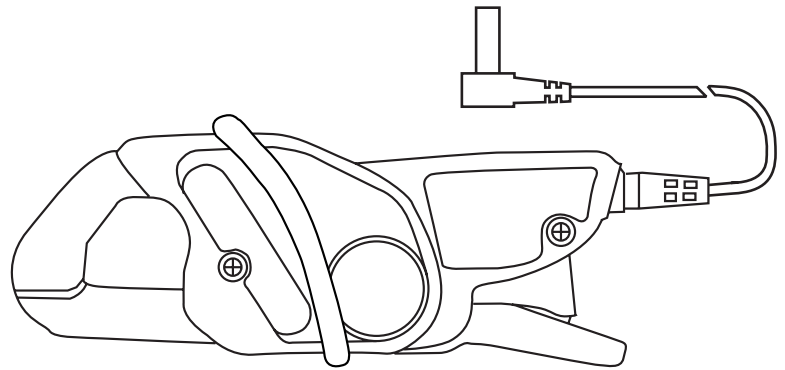

- **Dimensions:**
135 x 51 x 30 mm
- **Weight:**
180 g
- **Colours:**
Dark grey case with red jaws
- **Output:**
MN88:
Safety jacks (4 mm)
MN89:
1.5 m two-wire lead with double or reinforced insulation terminated by 2 elbowed male safety plugs (4 mm)

SAFETY SPECIFICATIONS

- **Electrical safety:**
Instrument with double insulation or reinforced insulation between the primary the secondary and the grippable part located under the guard as per IEC 1010-1 & IEC 1010-2-032
- 600 V category III, pollution degree 2
- 300 V category IV, pollution degree 2
- **Electromagnetic compatibility (EMC):**
EN 50081-1: class B
EN 50082-2:
- Electrostatic discharge: IEC 1000-4-2
- Radiated field: IEC 1000-4-3
- Fast transients: IEC 1000-4-4
- Magnetic field at 50/60 Hz: IEC 1000-4-8

(1) Conditions of reference: 23 °C ± 3 °K, 20 to 70 % RH, sinusoidal signal with frequency of 48 Hz to 65 Hz, external magnetic field < 40 A/m, no DC components, no external conductor with circulating current, conductor centred for measurement, load impedance > 1 MΩ + filter RC 2s.

(2) Out of reference domain

To order	Reference
AC current clamp model MN88 with operating manual	P01120410
AC current clamp model MN89 with operating manual	P01120415