

Infrared Temperature Measuring Instrument

testo 830



Laser measurement point marker and large lens for accurate measurement at long distances

Fast acting at two readings per second

Adjustable emissivity

Two selectable thresholds

Easy to handle pistol-grip design

Hold function and display of min./max. values

°C

°F

The testo 830 non-contact infrared thermometer family is used to measure surface temperatures across a wide range of applications from the HVAC, refrigerated warehousing, transport of pharmaceuticals, to food, food service and spot checking of perishable goods. The testo 830 is used in supermarkets to check open shelf refrigerated coolers as well as by car mechanics to check the transmission fluid's temperature to assure the right filling level.

No matter what is the 830's application, testo 830 assures the highest possible recording accuracy of 0.1 °C due to the new processor and redesigned electronic components.

The three instruments in the testo 830 family share the minimum / maximum reading and hold reading functions, and allow selection of the °C or °F units.

To assure the best fit to multitude of non-contact measurement applications Testo offers three versions of testo 830:

830-T1 is an all-around with one laser point and 10:1 lens magnification. 830-2T2 clearly marks the reading area with two laser points and comes with 12:1 lens and has the Type-K port for an external probe. 830-T4 has 30:1 lens allowing to read from longer distances as well as two-point laser to mark the spot reading area. The Type-K connection port as at the bottom of the grip.

Non-contact Infrared Thermometers

testo 830

Infrared thermometer with 1 pointing laser

testo 830-T1

testo 830-T1, infrared thermometer, 1 pointing laser, 10:1 lens, alarm function with adjustable threshold values, includes 9-volt battery and factory calibration document

Part no. 0560 8311



Infrared thermometer with 2 pointing lasers and external TC probe connection

testo 830-T2

testo 830-T2, infrared thermometer, 2 pointing lasers, 12:1 lens, alarm function with adjustable threshold values, Type-K port for external probes, includes 9-volt battery and factory calibration document

Part no. 0560 8312



The fast and universal infrared thermometer with 1-point laser sighting and 10:1 optics in ergonomic „pistol design“.

- Fast readings
- Laser pointing
- Adjustable alarm thresholds
- Audible and visual alarm signaling
- Easy to use grip/trigger operation
- Backlit display
- Emission settings (0.1 to 1.0)

testo 830-T2 Set

Set testo 830-T2 set includes infrared thermometer with protective leather case, includes spring tip surface probe (0602 0393), 9V battery and factory calibration document

Part no. 0563 8312

A non-contact infrared thermometer used in a wide range of applications where the measurement area needs to be clearly defined by 2 laser points. Testo 830-T2 with its new processor reads fast and displays precise results. Features include adjustable alarm thresholds and audible and visual alarms, and the backlit display comes handy in poorly lit areas.

In addition to the benefits of testo 830-T1:

- 2-point laser marking
- °C/°F contact measurement with external TCprobe
- Emissivity settings for the external TC probe

Non-Contact Infrared Thermometers

testo 830

Infrared thermometer with 30:1 lens for long distance measurement accuracy

testo 830-T4

testo 830-T4, infrared thermometer, 2 pointing lasers, 30:1 lens, alarm function with adjustable threshold values, Type-K port for external probe, includes 9V battery and factory calibration document

Part no. 0560 8314



testo 830-T4 Set

testo 830-T4 set includes infrared thermometer with protective leather case, includes spring tip surface probe (0602 0393), 9V battery and factory calibration document

Part no. 0563 8314

The 30:1 lens gives better accuracy at longer distances, but also helps when a smaller reading area is needed at shorter distances. At a distance of 1 m / 3.38 ft. the point diameter is only 3.6 cm / 1.42 inches. Availability of a large number of contact TC probes make testo 839-T4 a truly universal tool for the non-contact and contact type temperature measurements across a wide range of warehousing, HVAC, industrial, transport, pharma and the medical lab applications. With its new processor testo 830-T4 reads fast and displays precise results. Features include adjustable alarm thresholds and audible and visual alarms, and the backlit display comes handy in poorly lit areas.

- 30:1 lens for long distance measurement accuracy
- °C/°F contact measurement with external TC probe
- Emissivity settings for the external TC probe
- Adjustable alarm thresholds
- Audible and visual alarm signaling
- Backlit display

Technical data

Common technical data for all versions

Spectral range	8 to 14 μm	Battery type	9V battery
Emissivity	Adjustable 0.1 to 1.0	Battery life	15 h
Storage temperature	-40 to +70 $^{\circ}\text{C}$	Weight	200 g
Operating temperature	-20 to +50 $^{\circ}\text{C}$	Dimensions	190 x 75 x 38 mm
Warranty	2 years	Housing material	ABS

Varying technical data

	testo 830-T1	testo 830-T2	testo 830-T4
Measuring range			
Infrared	-30 to +400 $^{\circ}\text{C}$	-30 to +400 $^{\circ}\text{C}$	-30 to +400 $^{\circ}\text{C}$
Type K (NiCr-Ni)	-	-50 to +500 $^{\circ}\text{C}$	-50 to +500 $^{\circ}\text{C}$
Accuracy ± 1 digit			
Infrared	± 1.5 $^{\circ}\text{C}$ or 1.5 % of m.v. (+0.1 to +400 $^{\circ}\text{C}$) ± 2 $^{\circ}\text{C}$ or ± 2 % of m.v. (-30 to 0 $^{\circ}\text{C}$) the higher value applies	± 1.5 $^{\circ}\text{C}$ or ± 1.5 % of m.v. (+0.1 to +400 $^{\circ}\text{C}$) ± 2 $^{\circ}\text{C}$ or ± 2 % of m.v. (-30 to 0 $^{\circ}\text{C}$) the higher value applies	$\pm 1,5$ $^{\circ}\text{C}$ (-20 to 0 $^{\circ}\text{C}$) ± 2 $^{\circ}\text{C}$ (-30 to -20,1 $^{\circ}\text{C}$) ± 1 $^{\circ}\text{C}$ or 1% of m.v. (remaining range)
Type K (NiCr-Ni)	-	± 0.5 $^{\circ}\text{C}$ +0.5% of m.v.	± 0.5 $^{\circ}\text{C}$ +0.5% of m.v.
Resolution	0.1 $^{\circ}\text{C}$	0.1 $^{\circ}\text{C}$	0.1 $^{\circ}\text{C}$
Measurement rate			
Infrared	0.5 s	0.5 s	0,5 s
Type K (NiCr-Ni)	-	1.75 s	1.75 s
Meas. spot marking	1-point laser	2-point laser	2-point laser
Distance to measurement spot	10:1	12:1	30:1 (typical at a distance of 0.7 m to the measurement object 24 mm @ 700 mm (90%))

Optics

testo 830-T1

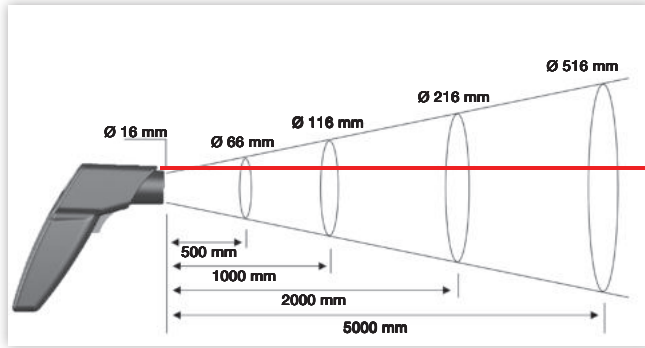

testo 830-T2

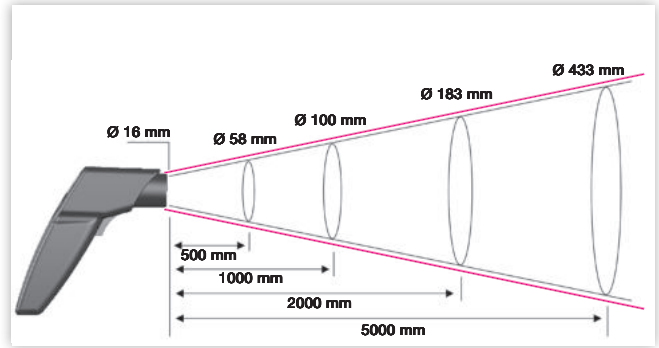

testo 830-T4

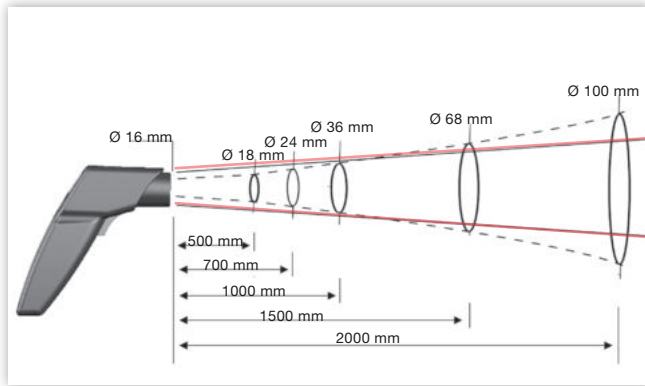





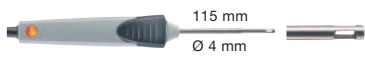

Accessories

Part no.

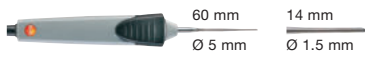
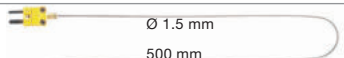

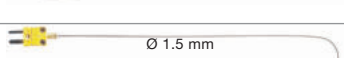

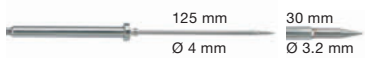
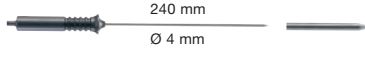
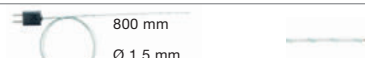
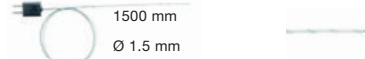
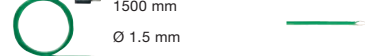



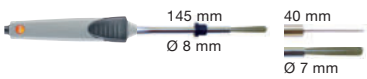
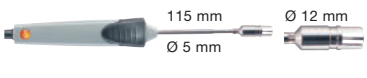
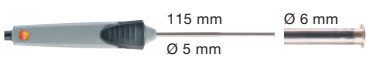

Adhesive tape, e.g. for reflective surfaces (roll, L.: 10 m, W.: 25 mm), $\epsilon = 0.95$, temperature resistant to +250 °C	0554 0051
Leather case to protect measuring instrument, including belt holder	0516 8302
NIST calibration certificate/temperature, infrared thermometer; calibration points 0°C; 75°C; 150°C	400 520 1911
NIST Temp certificate with 3 standard points 10 °C; 25 °C; 40 °C or -20 °C; 25 °C; 40 °C per channel/instrument	400 520 1901

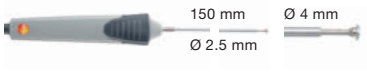
Probes testo 830-T2 / -T4

Probe type	Dimensions Probe shaft/probe shaft tip	Measuring range	Accuracy	t ₉₉	Part no.
Air probes					
Robust air probe, T/C Type K, Fixed cable 1.2 m		-60 to +400 °C	Class 2*	25 s	0602 1793
Immers./penetr. probes					
Efficient and fast-action immersion probe, waterproof, TC Type K, Fixed cable 1.2 m		-60 to +1000 °C	Class 1*	2 s	0602 0593
Fast-action, waterproof immersion/ penetration probe, TC Type K (Calibration not possible over +300 °C), Fixed cable 1.2 m		-60 to +800 °C	Class 1*	3 s	0602 2693
Immersion tip, flexible, TC Type K		-200 to +1000 °C	Class 1*	5 s	0602 5792
Immersion measurement tip, flexible, for measurements in air/ exhaust gases (not suitable for measurements in smelters), TC Type K		-200 to +1300 °C	Class 1*	4 s	0602 5693
Immersion tip, flexible, TC Type K		-200 to +40 °C	Class 3*	5 s	0602 5793
Waterproof immersion/penetration probe, TC Type K, Fixed cable 1.2 m		-60 to +400 °C	Class 2*	7 s	0602 1293
Food probes					
Waterproof food probe made of stainless steel (IP65), TC Type K, Fixed cable		-60 to +400 °C	Class 2*	7 s	0602 2292
Waterproof robust immersion/ penetration probe with metal protection hose Tmax +230°C, e.g. for monitoring temp. in cooking oil, T/C Type K, Fixed cable		-50 to +230 °C	Class 1*	15 s	0628 1292
Thermocouples					
Thermocouple with TC adapter, flexible, 800 mm long, fibre glass, TC Type K		-50 to +400 °C	Class 2*	5 s	0602 0644
Thermocouple with TC adapter, flexible, length 1500 mm , fibreglass, TC Type K		-50 to +400 °C	Class 2*	5 s	0602 0645
Thermocouple with TC adapter, flexible, 1500 mm long, PTFE, TC Type K		-50 to +250 °C	Class 2*	5 s	0602 0646

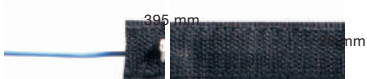
*According to standard EN 60584-2, the accuracy of Class 1 refers to -40 to +1000 °C (Type K), Class 2 to -40 to +1200 °C (Type K), Class 3 to -200 to +40 °C (Type K)

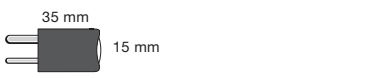
Probes testo 830-T2 / -T4

Probe type	Dimensions Probe shaft/probe shaft tip	Measuring range	Accuracy	t ₉₉	Part no.
Surface probes					
Fast-reacting paddle surface probe, for measurements in inaccessible places, e.g. narrow apertures and slots, TC Type K, Fixed cable	 145 mm Ø 8 mm 40 mm Ø 7 mm	0 to +300 °C	Class 2*	5 s	0602 0193
Fast-action surface probe with TC spring strip, also for uneven surfaces, measurement range short-term to +500°C, TC Type K, Fixed cable 1.2 m	 115 mm Ø 5 mm Ø 12 mm	-60 to +300 °C	Class 2*	3 s	0602 0393
Waterproof surface probe with widened measurement tip for flat surfaces, T/C Type K, Fixed cable 1.2 m	 115 mm Ø 5 mm Ø 6 mm	-60 to +400 °C	Class 2*	30 s	0602 1993
Fast-action surface probe with TC spring strip, bent, also for uneven surfaces, measurement range short-term to +500°C, TC Type K, Fixed cable 1.2 m	 80 mm Ø 5 mm 50 mm Ø 12 mm	-60 to +300 °C	Class 2*	3 s	0602 0993
Efficient, waterproof surface probe with small measurement head for flat surfaces, TC Type K, Fixed cable 1.2 m	 150 mm Ø 2.5 mm Ø 4 mm	-60 to +1000 °C	Class 1*	20 s	0602 0693
Flat head surface probe with telescopic handle max. 680 mm for measurements at hard-to-access points, TC Type K, Fixed cable, 1.6 m (correspondingly shorter when telescope extended)	 985 ± 5 mm 12 mm Ø 25 mm	-50 to +250 °C	Class 2*	3 s	0602 2394
Magnetic probe, adhesive force approx. 20 N, with magnets, for measurements on metal surfaces, TC Type K, Fixed cable	 35 mm Ø 20 mm	-50 to +170 °C	Class 2*	150 s	0602 4792
Magnetic probe, adhesive force approx. 10 N, with magnets, for higher temp., for measurements on metal surfaces, TC Type K, Fixed cable	 75 mm Ø 21 mm	-50 to +400 °C	Class 2*		0602 4892
Pipe wrap probe with velcro strip; for temperature measurement on pipes with diameter up to max. 120 mm; Tmax. +120 °C; TC Type K, Fixed cable	 395 mm	-50 to +120 °C	Class 1*	90 s	0628 0020
Pipe wrap probe for pipe diameter 5 to 65 mm, with exchangeable measuring head. Meas. range short-term up to +280 °C, TC Type K, Fixed cable		-60 to +130 °C	Class 2*	5 s	0602 4592
Spare meas. head for pipe wrap probe, TC Type K	 35 mm 15 mm	-60 to +130 °C	Class 2*	5 s	0602 0092
Clamp probe for measurements on pipes, pipe diameter 15 to 25 mm (max. 1"), meas. range short-term up to +130°C, TC Type K, Fixed cable		-50 to +100 °C	Class 2*	5 s	0602 4692

*According to standard EN 60584-2, the accuracy of Class 1 refers to -40 to +1000 °C (Type K), Class 2 to -40 to +1200 °C (Type K), Class 3 to -200 to +40 °C (Type K)

