

Model IWS12EX with analog output Dust explosion-proof

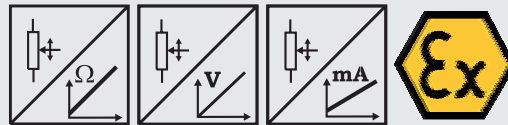

Sensor for hostile environments

- Protection class IP67
- Measurement ranges:
0 ... 100 mm to 0 ... 3000 mm
- Analog output
- Dust ex proof, category 3, zone 22
-  II 3D EEx T95°C IP67



| Specifications | Outputs | Potentiometer: 1 kΩ Voltage: 0...10 V Current: 4...20 mA, 2 or 3 wire |
|-----------------------------|---|---|
| | Material | Aluminium and stainless steel. Cable: stainless steel |
| Resolution | Essentially infinite | |
| Sensing Device | Precision potentiometer | |
| Connection | Cable output, standard length 1.5 m | |
| Linearity | Up to ±0.05 % full scale | |
| Weight (approx.) | ≤1500 mm: 1 kg; ≥2000 mm: 1.5 kg | |
| Operation temperature | -20 to +70 °C | |
| Conformity of standards | | |
| Explosion-proof | DIN EN 50281:1999, category 3, zone 22 | |
| EMC | DIN EN 61326:2004 | |
| Protection class of housing | DIN EN 60529:2000, IP67 | |
| Shock | DIN EN 60068-2-27:1993, 50 g 11 ms, 100 shocks | |
| Vibration | DIN EN 60068-2-6:1995, 20 g, 10 Hz ... 2 kHz, 10 cycles | |

| Order Code IWS12EX | Model Name | IWS12EX | - | - | - | - | - |
|--------------------|--|---------|---|---|---|---|---|
| Analog | | | | | | | |
| | Measurement Range (in mm) | | | | | | |
| | 100 / 125 / 500 / 1000 / 1250 / 1500 / 2000 / 2500 / 3000 | | | | | | |
| | Outputs (see pages 57 and 58) | | | | | | |
| | R1K = Potentiometer 1 kΩ (other values on request) | | | | | | |
| | 10V = with 0 ... 10 V signal conditioner | | | | | | |
| | 420A = with 4 ... 20 mA signal conditioner (2 wire) | | | | | | |
| | 420T = with 4 ... 20 mA signal conditioner (3 wire) | | | | | | |
| | Linearity | | | | | | |
| | L10 = ±0.10 % option: L05 = ±0,05 % L25 = ±0.25 % | | | | | | |
| | Connection | | | | | | |
| | KAB1,5M = Cable output, standard length 1.5 m | | | | | | |
| | Cable fixing | | | | | | |
| | M4 = M4 cable fixing | | | | | | |
| | SB0 = Cable clip | | | | | | |

Order Example: IWS12EX - 2500 - 420T - L10 - KAB1,5M - M4

Model IWS12EX with analog output Dust explosion-proof

| Cable Forces typical at 20 °C | Range | Maximum Pull-out Force | Minimum Pull-in Force |
|----------------------------------|-------|------------------------|-----------------------|
| | [mm] | [N] | [N] |
| | 100 | 5.2 | 2.8 |
| | 125 | 4.6 | 2.5 |
| | 500 | 5.9 | 2.6 |
| | 1000 | 5.5 | 2.4 |
| | 1250 | 4.8 | 2.1 |
| | 1500 | 10.4 | 6.4 |
| | 2000 | 8.1 | 5.0 |
| | 2500 | 6.7 | 4.0 |
| | 3000 | 6.2 | 3.0 |

Outline drawing

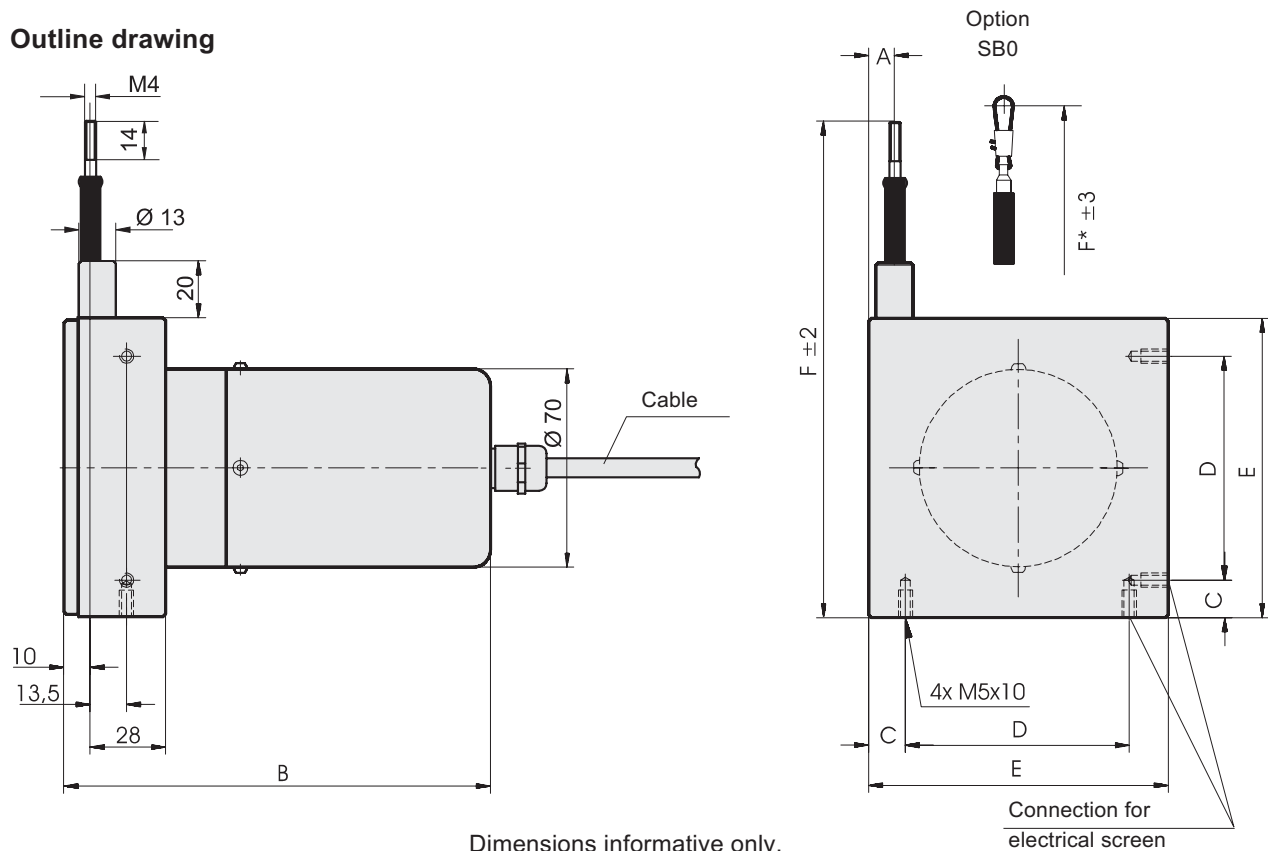

Dimensions informative only.
For guaranteed dimensions consult factory

| Dimensions | Range | A | B | C...E | F (F*) |
|------------|----------------|------|-----|-------------------|-----------|
| | [mm] | | | | |
| | 100; 500; 1000 | 18.5 | 112 | | |
| | 125; 1250 | 15.0 | 112 | C=14, D=43, E=71 | 141 (149) |
| | 1500 | 11.0 | 127 | | |
| | 2000 | 22.0 | 127 | | |
| | 2500 | 13.5 | 127 | C=15, D=79, E=109 | 179 (187) |
| | 3000 | 9.5 | 127 | | |

Output Specifications

R1K and 10V for IWS position sensors

| | | |
|--|-----------------------------------|---|
| Voltage divider R1K Potentiometer  | Excitation Voltage | 32 VDC max. at 1 kΩ (input power 1 W max.) |
| | Potentiometer Impedance | 1 kΩ ±10% |
| | Thermal coefficient | ±25 x 10 ⁻⁶ / °C full scale |
| | Sensitivity | Depends on measurement range, individual sensitivity of sensor specified on label |
| | Voltage Divider Utilization Range | Approx. 3% ... 97% of full range |
| | Operating Temperature | -20 ... +85 °C |

Signal diagram

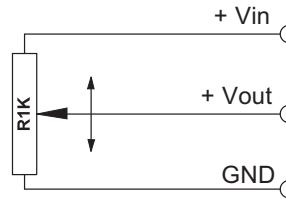

Note: The potentiometer must be connected as a voltage divider. The input impedance of the following processing circuit should be 10 MΩ min.

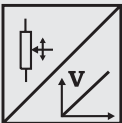
| | | |
|---|-------------------------|--|
| Signal conditioner 10V Voltage output  | Excitation Voltage | +18 ... +27 V DC non stabilized |
| | Excitation Current | 20 mA max. |
| | Output Voltage | 0 ... +10 V DC |
| | Output Current | 2 mA max. |
| | Output Load | > 5 kΩ |
| | Stability (Temperature) | ±50 x 10 ⁻⁶ / °C full scale |
| | Protection | Reverse polarity, short circuit |
| | Output Noise | 0,5 mV _{RMS} |
| | Operating Temperature | -20 ... +85 °C |
| | EMC | According to EN 61326:2004 |

Signal diagram

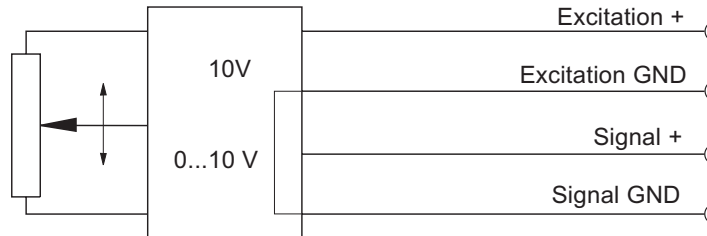

| Signal Wiring | Output signals | | Cable color | Connector pin no. |
|---------------|----------------|----------------|-------------|-------------------|
| | R1K | 10V | | |
| | + Vin | Excitation + | White | 1 |
| | GND | Excitation GND | Brown | 2 |
| | + Vout | Signal + | Green | 3 |
| | | Signal GND | Yellow | 4 |

Connection

Mating Connector

View to solder terminals

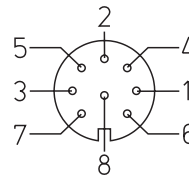

CONN-DIN-8F-W

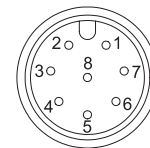

CONN-M12-8F-G

Output Specifications

420A and 420T for IWS position sensors

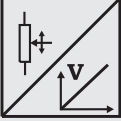
| | | |
|--|-------------------------|---|
| Signal conditioner 420A Current output (2 wire)  | Excitation Voltage | +12 ... 27 VDC non stabilized, measured at the sensor terminals |
| | Excitation Current | 35 mA max. |
| | Output Current | 4 ... 20 mA equivalent to 0 ... 100% range |
| | Stability (Temperature) | $\pm 100 \times 10^{-6} / ^\circ\text{C}$ full scale |
| | Protection | Reverse polarity, short circuit |
| | Output Noise | 0.5 mV _{RMS} |
| | Operating Temperature | -20 ... +85 °C |
| | EMC | According to EN 61326:2004 |

Signal Diagram

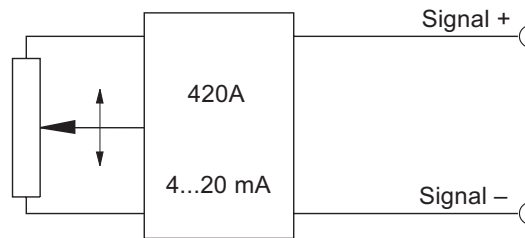

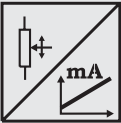
| | | |
|--|-------------------------|---|
| Signal Conditioner 420T Current output (3 wire)  | Excitation Voltage | +18...+27 V DC non stabilized |
| | Excitation Current | 40 mA max. |
| | Load Resistor | 350 Ω max. |
| | Output Current | 4 ... 20 mA equivalent to 0 ... 100% range |
| | Stability (Temperature) | $\pm 50 \times 10^{-6} / ^\circ\text{C}$ full scale |
| | Protection | Reverse polarity, short circuit |
| | Output Noise | 0.5 mV _{RMS} |
| | Operating Temperature | -20 ... +85 °C |
| | EMC | According to EN 61326:2004 |

Signal diagram

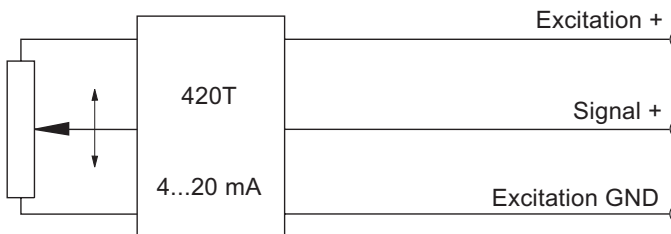

| Signal Wiring | Output signals | | Cable color | Connector pin no. |
|---------------|----------------|----------------|-------------|-------------------|
| | 420A | 420T | | |
| Signal + | | Excitation + | White | 1 |
| Signal - | | Excitation GND | Brown | 2 |
| | | Signal + | Green | 3 |

Connection

Mating Connector

View to solder terminals

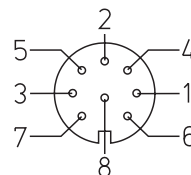

CONN-DIN-8F-W

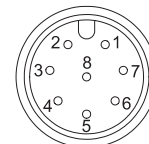

CONN-M12-8F-G

Output Specification

PMU for IWS position sensors

| | | |
|--|--------------------------------------|---|
| Signal Conditioner PMU, adjustable Voltage output and current output (3 wire) | Excitation voltage | +18 ... 27 V DC |
| | Excitation current | 50 mA max. |
| | Voltage output | 0 ... 10 V |
| | Output current | 10 mA max. |
| | Output load | 1 k Ω min. |
| | Current output | 4 ... 20 mA (3 wire) |
| | Load resistor | 500 Ω max. |
| | Adjustment | |
| | Activation of offset and gain adjust | Connect with excitation GND (0 V) |
| | Scalable range | 90 % max. full scale |
| | Stability (Temperature) | $\pm 50 \times 10^{-6}$ / $^{\circ}\text{C}$ full scale |
| | Protection | Reverse polarity, short circuit |
| | Output noise | 1 mV _{eff} |
| Operating temperature | -20 ... +85 $^{\circ}\text{C}$ | |
| EMC | According to EN 61326:2004 | |

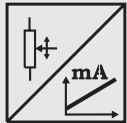
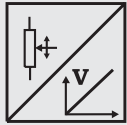

Signal diagram

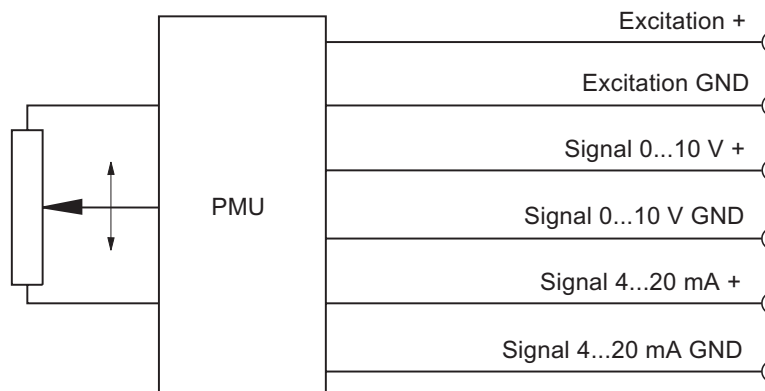

| Signal wiring | Output signals | Connector pin no. |
|---------------|----------------------|-------------------|
| | Excitation + | 1 |
| | Excitation GND | 2 |
| | Signal 0...10 V + | 3 |
| | Signal 0...10 V GND | 4 |
| | Signal 4...20 mA + | 5 |
| | Signal 4...20 mA GND | 6 |
| | Offset | 7 |
| | Gain | 8 |

Connection

Mating Connector

