

Operating Manual Pallet scales

KERN UOB

Version 1.3
05/2009
GB



UOB-BA-e-0913



KERN UOB

Version 1.3 05/2009

Operating Manual

Pallet scales

Table of Contents

1	Technical Data	4
2	Declaration of conformity	5
3	Appliance overview	6
4	Basic Information (General)	6
4.1	Proper use	6
4.2	Improper Use	6
4.3	Warranty	7
4.4	Monitoring of Test Resources	7
5	Basic Safety Precautions	8
5.1	Pay attention to the instructions in the Operation Manual	8
5.2	Personnel training	8
6	Transportation & Storage	8
6.1	Testing upon acceptance	8
6.2	Packaging	8
7	Unpacking, Setup and Commissioning	9
7.1	Installation Site, Location of Use	9
7.2	Unpacking	10
7.2.1	Scope of delivery	10
7.3	Placing	10
7.3.1	Assembly instructions for the use of the wall fixture	11
7.4	Mains connection	11
7.5	Battery operation	11
7.6	Initial Commissioning	12
7.7	Adjustment	12
7.8	Adjustment	12
8	Operation	15
8.1	Overview of display	15
8.2	Keyboard overview	16
8.3	Operation limits	16

8.4	Load or unload the pallet scales	17
8.5	Weighing	17
8.6	Taring (TARE button)	18
8.7	Hold function (animal weighing function)	19
8.8	Weight units	19
9	<i>Service, maintenance, disposal</i>	20
9.1	Cleaning	20
9.2	Service, maintenance	20
9.3	Disposal	20
10	<i>Instant help</i>	21

1 Technical Data

KERN	UOB 600K200	UOB 1.5T0.5
Readability (d)	200 g	0.5 kg
Weighing range (max)	600 kg	1500 kg
Reproducibility	300 g	0.5 kg
Linearity	400 g	1 kg
Recommended adjustment weight, not added (class)	500 kg (M2)	1000 kg (M2)
Stabilization time (typical)	3 sec.	
Operating temperature	+5 C + 35° C	
Humidity of air	max. 95 % (not condensing)	
Terminal (B x D x H) mm	210 x 110 x 45	
Weighing plate (mm)	1255 x 820 x 90.5	
Weight kg (net)	36.7	



2 Declaration of conformity



KERN & Sohn GmbH
 D-72322 Balingen-Frommern
 Postbox 4052
 email: info@kern-sohn.de

Phone: 0049-[0]7433- 9933-0
 Fax: 0049-[0]7433-9933-149
 Internet: www.kern-sohn.de

Declaration of conformity

EC-Konformitätserklärung
 EC- Déclaration de conformité
 EC-Dichiarazione di conformità
 EC- Declaração de conformidade
 EC-Deklaracja zgodności

EC-Declaration of -Conformity
 EC-Declaración de Conformidad
 EC-Conformiteitverklaring
 EC- Prohlášení o shode
 EC-Заявление о соответствии

D	Konformitäts- erklärung	Wir erklären hiermit, dass das Produkt, auf das sich diese Erklärung bezieht, mit den nachstehenden Normen übereinstimmt.
GB	Declaration of conformity	We hereby declare that the product to which this declaration refers conforms to the following standards.
CZ	Prohlášení o shode	Tímto prohlašujeme, že výrobek, kterého se toto prohlášení týká, je v souladu s níže uvedenými normami.
E	Declaración de conformidad	Manifetamos en la presente que el producto al que se refiere esta declaración está de acuerdo con las normas siguientes
F	Déclaration de conformité	Nous déclarons avec cela responsabilité que le produit, auquel se rapporte la présente déclaration, est conforme aux normes citées ci-après.
I	Dichiarazione di conformità	Dichiariamo con ciò che il prodotto al quale la presente dichiarazione si riferisce è conforme alle norme di seguito citate.
NL	Conformiteit- verklaring	Wij verklaren hiermede dat het product, waarop deze verklaring betrekking heeft, met de hierna vermelde normen overeenstemt.
P	Declaração de conformidade	Declaramos por meio da presente que o produto no qual se refere esta declaração, corresponde às normas seguintes.
PL	Deklaracja zgodności	Niniejszym oświadczamy, że produkt, którego niniejsze oświadczenie dotyczy, jest zgodny z poniższymi normami.
RUS	Заявление о соответствии	Мы заявляем, что продукт, к которому относится данная декларация, соответствует перечисленным ниже нормам.

Electronic Scale: KERN EOB, EOE, EOS, BOBP, UOB, EOL

Mark applied	EU Directive	Standards
CE	2004/108/EC	EN 61000-6-1 : 2007 EN 61000-3-2 : 2006 EN 61000-3-3 : 1995+A1 : 2001+A2:2005 EN 61000-6-3 :2007

Date: 27.10.2008

Signature: 

Gottl. KERN & Sohn GmbH
 Management

Gottl. KERN & Sohn GmbH, Ziegelei 1, D-72336 Balingen, Tel. +49-[0]7433/9933-0, Fax +49-[0]7433/9933-149

3 Appliance overview

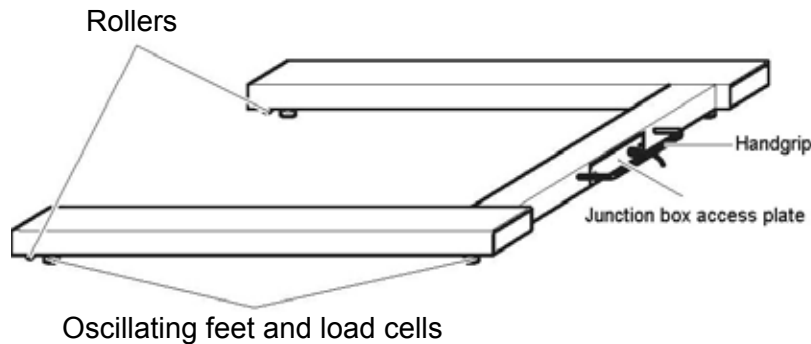

4 Basic Information (General)

4.1 Proper use

The balance you purchased is intended to determine the weighing value of material to be weighed. It is intended to be used as a “non-automatic” balance, i.e. the material to be weighed is manually put on the weighing plate. The center of gravity of the load should be in the middle of the plate. As soon as a stable weighing value is reached the weighing value can be read.

4.2 Improper Use

Do not use balance for dynamic weighing. In the event that small quantities are removed or added to the material to be weighed, incorrect weighing results can be displayed due to the “stability compensation” in the balance. (Example: Slowly draining fluids from a container on the balance.)

Do not leave permanent load on the balance. This may damage the measuring system.

Impacts and overloading exceeding the stated maximum load (max) of the balance, minus a possibly existing tare load, must be strictly avoided. Balance may be damaged by this.

Never operate balance in explosive environment. The serial version is not explosion protected.

The structure of the balance may not be modified. This may lead to incorrect weighing results, safety-related faults and destruction of the balance.

The balance may only be used according to the described conditions. Other areas of use must be released by KERN in writing.

4.3 Warranty

Warranty claims shall be voided in case

- Our conditions in the operation manual are ignored
- The appliance is used outside the described uses
- The appliance is modified or opened
- Mechanical damage and damage caused by media, liquids
- Natural wear and tear
- The appliance is improperly set up or incorrectly electrically connected
- The measuring system is overloaded

4.4 Monitoring of Test Resources

In the framework of quality assurance the measuring-related properties of the balance and, if applicable, the testing weight, must be checked regularly. The responsible user must define a suitable interval as well as type and scope of this test. Information is available on KERN's home page (www.kern-sohn.com) with regard to the monitoring of balance test substances and the test weights required for this. In KERN's accredited DKD calibration laboratory test weights and balances may be calibrated (return to the national standard) fast and at moderate cost.

5 Basic Safety Precautions

5.1 Pay attention to the instructions in the Operation Manual

Carefully read this operation manual before setup and commissioning, even if you are already familiar with KERN balances.

5.2 Personnel training

The appliance may only be operated and maintained by trained personnel.

6 Transportation & Storage

6.1 Testing upon acceptance

When receiving the appliance, please check packaging immediately, and the appliance itself when unpacking for possible visible damage.

6.2 Packaging

Keep all parts of the original packaging in case you need to return the appliance. Only use original packaging for returning. Before sending, disconnect all connected cables and loose/movable parts.

7 Unpacking, Setup and Commissioning

7.1 Installation Site, Location of Use

The balances are designed in a way that reliable weighing results are achieved in common conditions of use.

You will work accurately and fast, if you select the right location for your balance.

Therefore, observe the following for the installation site:

- Place the balance on a firm, level surface;
- Avoid extreme heat as well as temperature fluctuation caused by installing next to a radiator or in the direct sunlight;
- Protect the balance against direct draughts due to open windows and doors;
- Avoid jarring during weighing;
- Protect the balance against high humidity, vapors and dust;
- Do not expose the device to extreme dampness for longer periods of time. Non-permitted condensation (condensation of air humidity on the appliance) may occur if a cold appliance is taken to a considerably warmer environment. In this case, acclimatize the disconnected appliance for ca. 2 hours at room temperature.
- Avoid static charging of the material to be weighed, weighing container and windshield.

If electro-magnetic fields or static charge occur, or if the power supply is unstable major deviations on the display (incorrect weighing results) are possible. In that case, the location must be changed.



- The floor at the installation site must be able to carry safely the weight of the maximally loaded scales at the resting points.
- The installation site must be completely even in order to ensure a horizontal position.

7.2 Unpacking

- ⇒ Take out of the cardboard box the balance and the weighing terminal.
- ⇒ Make sure that the balance and the weighing terminal are not damaged during transport.

7.2.1 Scope of delivery

Serial accessories:

KERN UOB
<ul style="list-style-type: none">• Platform (varnished metal) and display equipment• 4 x adjustable feet• Mains power supply• Wall fixture (with fixing screws)• Operating Manual

7.3 Placing

- ⇒ Place pallet scales on the installation site. To transport the pallet scales: Lift-off by the handle and move it on the conveyor rollers.
- ⇒ Avoid any pressure on the load cells.
- ⇒ Put the cable to the weighing terminal in a manner that it is protected against damage.

7.3.1 Assembly instructions for the use of the wall fixture

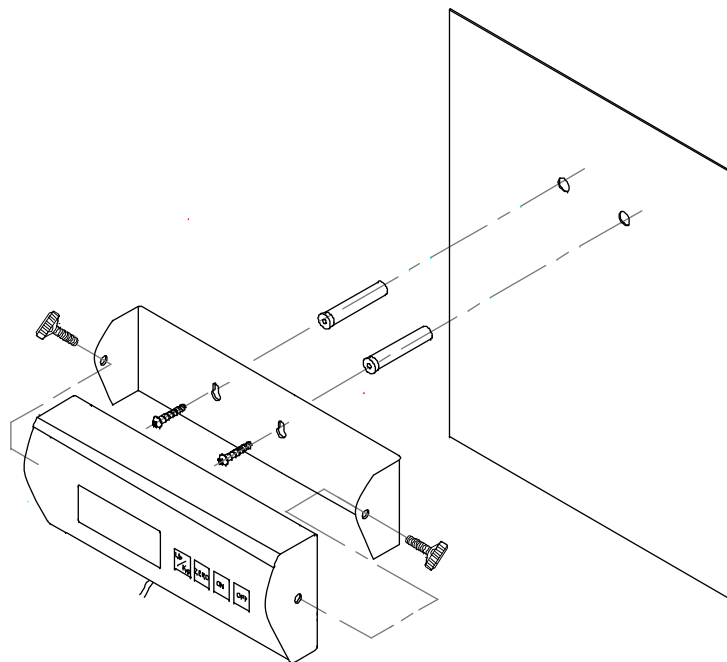

7.4 Mains connection

Power is supplied via the external mains adapter. The stated voltage value must be the same as the local voltage.

Only use original KERN mains adapters. Using other makes requires consent by KERN.

7.5 Battery operation

⇒ Remove battery cover from under the display unit. Connect 6 x 1.5V mignon cells. Reinsert the battery cover.

In order to save the battery, the balance switches automatically off after 3 minutes without weighing.

If the batteries are run down, "LO" appears in the display.

⇒ Press  key and replace the batteries immediately.

If the balance is not used for a longer time, take out the batteries and store them separately. Leaking battery liquid could damage the balance.

7.6 Initial Commissioning

A warming up time of 5 minutes after switching on stabilizes the measuring values.

The accuracy of the balance depends on the local acceleration of gravity. Strictly observe hints in chapter Adjustment.

7.7 Adjustment

















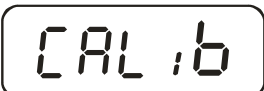

As the acceleration value due to gravity is not the same at every location on earth, each balance must be coordinated - in compliance with the underlying physical weighing principle - to the existing acceleration due to gravity at its place of location (only if the balance has not already been adjusted to the location in the factory). This adjustment process must be carried out during the initial start-up, after change in location and variation of surrounding temperature. To receive accurate measuring values it is also recommended to adjust the balance periodically in weighing operation.











7.8 Adjustment

With an adjustment weight, the weighing accuracy can be checked and re-adjusted at any time.

Procedure when adjusting:

Observe stable environmental conditions. A short warming up time of ca. 5 minutes is recommended for stabilization.

Operation	Display
⇒ Use the  button to switch the balance on.	
⇒ Keep  button depressed for approx. 3 sec until "SETUP" is displayed followed by "UNIT"	 ↓ 
⇒ Press the  button as often as required until "CAL ib" is displayed	
⇒ Press  button	
⇒ Press  button . The appeared triangle ◀ must be located in the upper left part of the display. If this is this not the case, press the  button.	
⇒ Press the  button repeatedly until "CAL 0" is displayed.	 ↓ 
⇒ Press  button, in the display appears a numeric value ⇒ After that press the  button.	 (Example) ↓ 

<p>⇒ Press  button</p>	
<p>⇒ Press  button .</p> <p>Enter the required size of the adjustment weight (See Section 1, "Technical Data"):</p> <p>⇒ Press the  button to select the item to be changed and press the  button to select the numerical value.</p>	 <p>(Example)</p>
<p>⇒ Confirm with  button</p>	
<p>⇒ Place the adjustment weight carefully in the centre of the weighing plate and a numerical value will appear in the display.</p> <p>⇒ Press  button . The adjustment process is started.</p>	 <p>(Example)</p>
<p>The balance will automatically return to Weighing mode upon successful completion of the adjustment and will display the weight of the adjustment weight.</p> <p>Take away adjustment weight.</p>	 <p>(Example)</p>



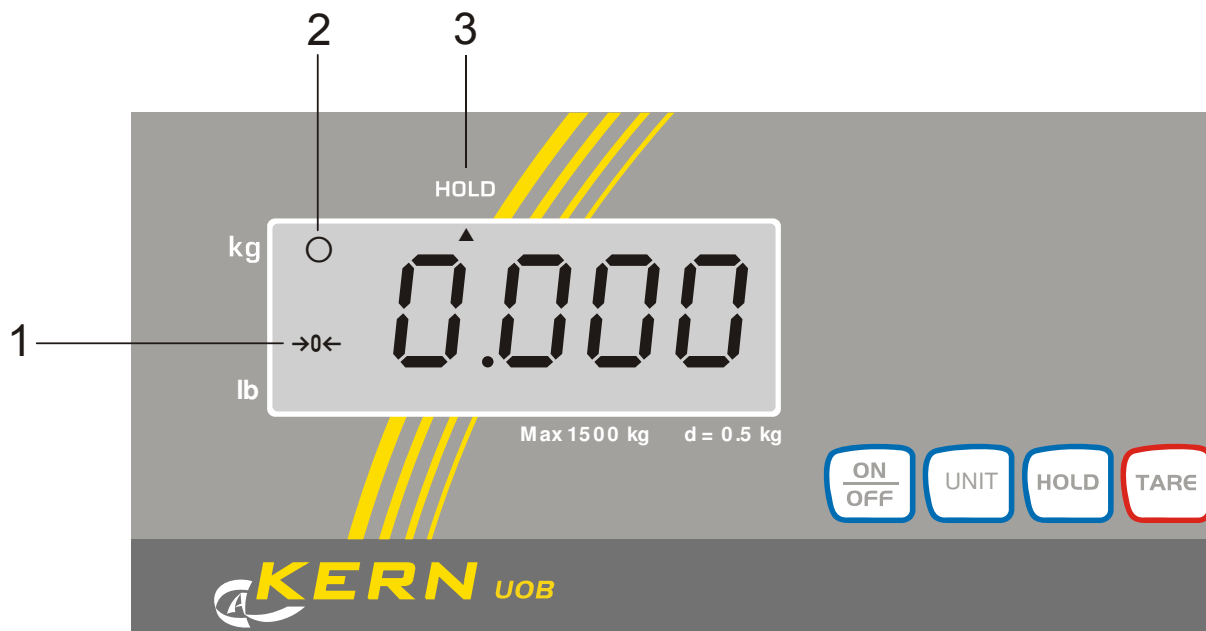

8 Operation

8.1 Overview of display



No.	Display	Description
1	[→0←]	Balance zero display: Should the balance not display exactly zero despite an empty scale pan, press the [→0←] button. Your balance will be set to zero after a short standby time.
2	[o]	Stability display: If the display shows the stability display [o] the balance is in a stable status. The [o] indication disappears if the condition is unstable.
3	[Hold] ▲	Hold/ animal weighing function active

8.2 Keyboard overview

Key	Description
	Turn on/off balance
	Set balance to zero
	Hold/ animal weighing function
	Tare balance

8.3 Operation limits

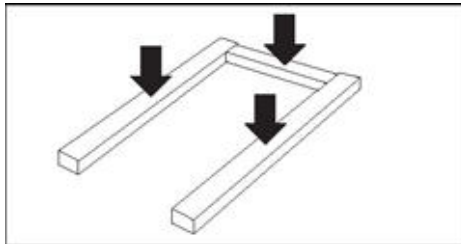

The pallet scales is designed for an even distributed load.

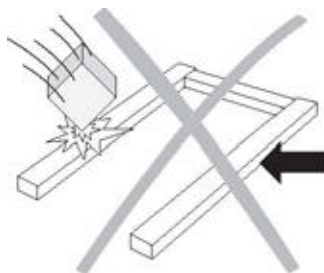



- Avoid falling load, shock loads and impacts from the side.
- The forks of the fork lift truck may not touch the pallet or the balance during weighing process.
- Do not move the balance at any moment, when it is loaded.



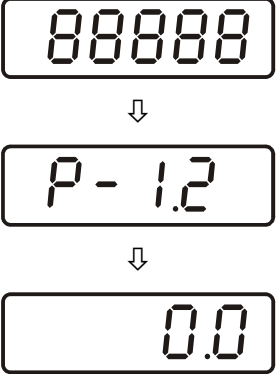

8.4 Load or unload the pallet scales

- Place the load on the scales using a pallet lifting truck, a crane or a forklift truck. Ensure that the load is not swinging when it is placed onto the scales.
- Lift the load first vertically at least 10 cm above the scales before it is removed or newly placed.

8.5 Weighing

Operation	Display
<p>⇒ Use the  button to switch the balance on. The balance shows for approx. 3 seconds „88888“ and then „P1.1“ in the display and then goes to „0“.</p> <p>Now it is ready for operation.</p>	 <p>The display shows a sequence of three states: first, eight 8s (88888); second, P-1.2; and third, 0.0. Downward arrows indicate the progression between these states.</p>
<p>Should the display flash or not be on „0“, press the TARE button.</p>	
<p>⇒ Only now (!) place goods onto weighing plate. The result is displayed.</p>	 <p>(Example)</p>
<p>If the material to be weighed is heavier than the weighing range, the display will show "Err" (=Overload).</p>	

8.6 Taring (TARE button)

Operation	Display
⇒ Switch-on the balance using the  key and wait for the „0“ display.	
⇒ Place the tare vessel on the weighing plate and press the  button. The balance display goes to „0“. The weight of the container is now internally saved.	
If one after finishing the weighing process presses again the TARE button, „0“ appears anew in the display.	

The taring process can be repeated any number of times, e.g. when adding several components for a mixture (adding).







The limit is reached when the whole weighing range is exhausted.

After removing the taring container the total weight is displayed as negative display.

8.7 Hold function (animal weighing function)

The balance has an integrated animal weighing function (mean value calculation). Using this function it is possible to weigh domestic or small animals exactly (min. load 1% of the max. one), although they do not stand quiet on the weighing plate.

i There is no average value calculation in the event of too much movement (heavy display oscillation).

Operation	Display
⇒ Switch-on the balance using the  key and wait for the „0“ display.	
⇒ Press  button . „Hold“ will appear in the display and the ▲ under „HOLD flashes.	
⇒ Put goods to be weighed (animal) on the weighing plate. As long as the triangle flashes, the balance takes up several measured values and displays then the calculated mean value.	 (Example)
Press the  button repeatedly to reset the balance to normal Weighing mode.	
Press the  button once more to repeat this function as often as required.	

8.8 Weight units

There are two units available „kg“ and „lb“.

The weighing unit is selected by the  button.

The respective unit is symbolized by the triangle ◀ right next to the display!

Unit conversion: **1 kg = 2.20462 lb**

9 Service, maintenance, disposal

9.1 Cleaning

Before cleaning, please disconnect the appliance from the operating voltage.

Please do not use aggressive cleaning agents (solvents or similar agents), but a cloth dampened with mild soap suds. Ensure that no liquid penetrates into the device and wipe with a dry soft cloth.

Loose residue sample/powder can be removed carefully with a brush or manual vacuum cleaner.

Spilled weighing goods must be removed immediately.

9.2 Service, maintenance

The appliance may only be opened by trained service technicians who are authorized by KERN.

Before opening, disconnect from power supply.

9.3 Disposal

Disposal of packaging and appliance must be carried out by operator according to valid national or regional law of the location where the appliance is used.

10 Instant help

In case of an error in the program process, briefly turn off the balance and disconnect from power supply. The weighing process must then be restarted from the beginning.

Help:

Fault

Possible cause

The displayed weight does not glow.

- The balance is not switched on.
- The mains supply connection has been interrupted (mains cable not plugged in/faulty).
- Power supply interrupted.

The displayed weight is permanently changing

-

- Draught/air movement
- Table/floor vibrations
- The weighing plate is in contact with foreign matter.
- Electromagnetic fields / static charging (choose different location/switch off interfering device if possible)

The weighing value is obviously wrong

- The display of the balance is not at zero
- Adjustment is no longer correct.
- Great fluctuations in temperature.
- Electromagnetic fields / static charging (choose different location/switch off interfering device if possible)

Should other error messages occur, switch balance off and then on again. If the error message remains inform manufacturer.