

## Installation instructions floor scale

# KERN KFP\_V20NM

Version 1.2  
2017-10  
GB



**KFP V20NM-IA-e-1712**



# KERN KFP\_V20NM

Version 1.2 2017-10

Installation instructions floor scale

## Contents

<b>1</b>	<b>General</b> .....	<b>3</b>
<b>2</b>	<b>Technical data</b> .....	<b>3</b>
<b>3</b>	<b>Basic Information (General)</b> .....	<b>4</b>
3.1	Documentation .....	4
3.2	Proper use .....	4
3.3	Improper Use .....	4
3.4	Warranty .....	4
3.5	Monitoring of Test Resources .....	5
<b>4</b>	<b>Basic Safety Precautions</b> .....	<b>5</b>
4.1	Pay attention to the instructions in the Operation Manual.....	5
4.2	Personnel training.....	5
<b>5</b>	<b>Transport and storage</b> .....	<b>5</b>
5.1	Testing upon acceptance .....	5
5.2	Packaging / return transport .....	5
<b>6</b>	<b>Unpacking, Setup and Commissioning</b> .....	<b>6</b>
6.1	Installation Site, Location of Use .....	6
6.2	Unpacking, Scope of delivery .....	7
6.3	Assembly, levelling .....	9
6.4	Connecting a display unit .....	10
<b>7</b>	<b>Operation</b> .....	<b>10</b>
7.1	Operation limits.....	11
7.2	Operation with access ramps .....	11
7.3	Load/unload weighing system .....	11
<b>8</b>	<b>Service, maintenance, disposal</b> .....	<b>12</b>
8.1	Daily check .....	12
8.2	Cleaning .....	12
8.3	Service, maintenance .....	12
8.4	Disposal.....	12
8.5	Instant help .....	13
<b>9</b>	<b>Service documentation</b> .....	<b>14</b>
9.1	Overview, setting regulation, tolerances .....	14
9.2	Check and adjustment of the corner load.....	16
<b>10</b>	<b>Deadload and Overload settings</b> .....	<b>18</b>

## 1 General

These installation instruction contain all data necessary for placing and commissioning the following weighing bridges:

**KERN KFP 600V20SNM**

**KERN KFP 600V20NM**

**KERN KFP 1500V20SNM**

**KERN KFP 1500V20NM**

**KERN KFP 3000V20NM**

**KERN KFP 3000V20LNM**

## 2 Technical data

Model	Weighing range Max	Readability d	Verification value e	Minimum load Min	Cable length approx.	Net weight approx.
	kg	g	g	kg	m	kg
KFP 600V20SNM	600	200	200	4	5	105
KFP 600V20NM	600	200	200	4	5	135
KFP 1500V20SNM	1500	500	500	10	5	105
KFP 1500V20NM	1500	500	500	10	5	135
KFP 3000V20NM	3000	1000	1000	20	5	135
KFP 3000V20LNM	3000	1000	1000	20	5	151

### 3 Basic Information (General)

#### 3.1 Documentation

These installation instruction contain all data necessary for placing and commissioning the weighing bridges KERN KFP V20.

In combination with a display unit, described below as weighing system, for operation configuration, please refer to the operating instructions of the display unit.

#### 3.2 Proper use

The balance you purchased is intended to determine the weighing value of material to be weighed. It is intended to be used as a “non-automatic balance”, i.e. the material to be weighed is manually and carefully placed in the centre of the weighing plate.. As soon as a stable weighing value is reached the weighing value can be read.

#### 3.3 Improper Use

Do not leave permanent load on the weighing bridge. This may damage the measuring system.

Impacts and overloading exceeding the stated maximum load (max) of the weighing system, minus a possibly existing tare load, must be strictly avoided. The weighing system could be damaged.

Never operate in an explosive environment. The serial version is not explosion protected.

Changes to the weighing system's design are not permitted. This may lead to incorrect weighing results, safety-related faults and destruction of the balance.

The weighing system unit may only be operated in accordance with the described default settings. Other areas of use must be released by KERN in writing.

#### 3.4 Warranty

Warranty claims shall be voided in case

- Our conditions in the operation manual are ignored
- The appliance is used outside the described uses
- Structural changes of the device
- Mechanical damage and damage caused by media, liquids
- Natural wear and tear
- The appliance is improperly set up or incorrectly electrically connected
- Overload of the measuring system

### 3.5 Monitoring of Test Resources

In the framework of quality assurance the measuring-related properties of the weighing system and, if applicable, the testing weight, must be checked regularly. The responsible user must define a suitable interval as well as type and scope of this test. Information is available on KERN's home page ([www.kern-sohn.com](http://www.kern-sohn.com)) with regard to the monitoring of weighing system test substances and the test weights required for this. In KERN's accredited DKD calibration laboratory test weights and weighing systems may be calibrated (return to the national standard) fast and at moderate cost.

## 4 Basic Safety Precautions

### 4.1 Pay attention to the instructions in the Operation Manual



Carefully read this operation manual before setup and commissioning, even if you are already familiar with KERN balances.

### 4.2 Personnel training

The appliance may only be operated and maintained by trained personnel. The installation of a display unit must only be carried out by a well acquainted specialist with the workings of weighing balances.

## 5 Transport and storage

### 5.1 Testing upon acceptance

When receiving the appliance, please check packaging immediately, and the appliance itself when unpacking for possible visible damage.

### 5.2 Packaging / return transport



- ⇒ Keep all parts of the original packaging for a possibly required return.
- ⇒ Only use original packaging for returning.
- ⇒ Prior to dispatch disconnect all cables and remove loose/mobile parts.
- ⇒ Reattach possibly supplied transport securing devices.
- ⇒ Secure all parts against shifting and damage.

## 6 Unpacking, Setup and Commissioning

### 6.1 Installation Site, Location of Use

The weighing bridges are designed in a way that reliable weighing results are achieved in common conditions of use.

You will work accurately and fast, if you select the right location for your weighing system.

**On the installation site observe the following:**

- Place the weighing system on a firm, level surface.  
The floor at the installation site must be able to carry safely the weight of the maximally loaded weighing bridge at the resting points. At the same time it should be sufficiently stable, that no vibrations may occur during weighing work.
- In the installation site possibly no vibrations, e.g. by neighbouring machines should occur.
- Do not use the weighing system in an explosive environment.
- Avoid extreme heat as well as temperature fluctuation caused by installing next to a radiator or in the direct sunlight.
- Protect the weighing system against direct draughts e.g. due to open windows and doors.
- Use weighing system only in dry environment, protect it against high humidity, vapours and dust.
- Do not expose the device to extreme dampness for longer periods of time.  
Non-permitted condensation (condensation of air humidity on the appliance) may occur if a cold appliance is taken to a considerably warmer environment. In this case, acclimatize the disconnected appliance for ca. 2 hours at room temperature.
- Avoid jarring during weighing.
- Avoid static charge of goods to be weighed or weighing container.
- Keep away chemicals (such as liquids or gasses), which could attack and damage the balance inside or from outside.
- Keep IP protection of the device.
- Major display deviations (incorrect weighing results) may be experienced should electromagnetic fields (e.g. due to mobile phones or radio equipment), static electricity accumulations or instable power supply occur. Change location or remove source of interference.

## 6.2 Unpacking, Scope of delivery



CAUTION

- + **Danger for the back!**  
The weighing bridge is relatively heavy. Always use a suitable lifting device to lift it out of the packaging or to transport it to the required installation site.
- + **Do not step under the suspended load, risk of injury!**

- Floor scale
- Weighing cell feet
- User manual

1. Remove outer packaging and packaging material.
2. Remove covers.
3. Assemble eye bolts
4. Lift the weighing bridge equally off the packaging material, see caution note. Secure the weighing bridge that it cannot fall down when it is lifted.
5. Ensure that the contents of package is complete.

**Scope of delivery:**

- Weighing bridge with assembled connection cable
  - 4 weighing cell feet
- 2 eye bolts
- Operating instructions

According to the version, for assembling the weighing bridge the following accessories (optional) must be available:

(A) **2 access ramps**

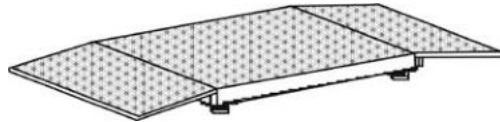

or

(B) **1 access ramp and 1 foot plate set**

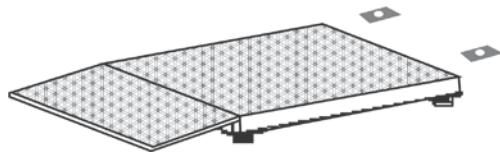

or

(C) **2 foot plate sets**

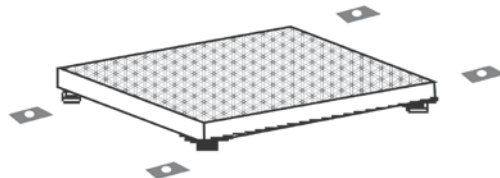



### 6.3 Assembly, levelling

Accurate weighing results require a weighing bridge with perfect horizontal alignment. During initial installation and after each change of work area it is necessary to level the weighing bridge.

#### Placing the weighing bridge:

1. Prior to the final placing, install the four weighing cell feet.
2. Place the weighing bridge equally on the installation site and check if it is in an even position and all four feet are in contact with the floor. Level the weighing bridge by turning the weighing cell feet. For this purpose use an external levelling appliance, e.g. a water level.
3. Remove the eye bolts, re-assemble the covers of the eye bolts and weighing cell feet.
4. Ensure that the connecting cable is not damaged or squeezed during lifting and placing.

#### Placing the weighing bridge with access ramps and/or foot plates:

- ⇒ Prior to step 2 (see Placing the weighing bridge) mark and fix the position of the ramps or the foot plates.
- ⇒ Place the weighing bridge equally on the installation site. In the area of the installation site of the weighing bridge, especially in the area of the weighing cell feet, observe the evenness and the horizontal alignment of the foot plates and ramps. Compensate minor height differences with the help of the adjustable weighing cell feet. For this purpose use an external levelling appliance, e.g. a water level.
- ⇒ Remove the eye bolts, re-assemble the covers of the eye bolts and weighing cell feet.
- ⇒ Ensure that the connecting cable is not damaged or squeezed during lifting and placing.



- + **The weighing bridge must be aligned with the help of a water level.**
- + **All setting feet must rest equally.**

#### Verified weighing systems:

In case of verified weighing systems the weighing bridge must be firmly fixed on the floor. This is essential for the reproducibility of the measuring results. Optionally using two access ramps or two pairs of foot plates or a combination of both.

## 6.4 Connecting a display unit

### Attention

Put the connecting cable to the display unit in a manner that it is protected against damage.

### Description of the connection cable:

terminal	Color	State
EXC+ [IN+]	red	voltage +
SIG + [OUT+]	blue	signal +
SIG -[OUT-]	green	signal -
EXC -[IN- ]	yellow	voltage -

## 7 Operation

Information about

- **Network connection** (power is supplied via the connecting cable of the display unit)
- **Initial Commissioning**
- **Connection of peripheral devices**
- **Adjustment, linearization and verification** (only the complete balance is verifiable, i.e. weighing bridge in conjunction with a suitable display unit)

and the correct operation you will find in the operating instructions included in the scope of delivery of the display unit.

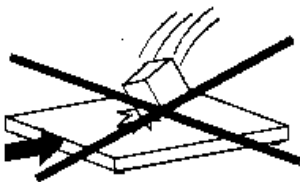

So a continuous optimal performance is guaranteed:

- Avoid falling load, shock loads and impacts from the side!
- For weighing operation, all objects must be placed centrally of the weighing bridge and may not hang over the edges or the ramps.
- Check adjustment at regular intervals.

## 7.1 Operation limits

- The weighing bridges are designed extremely robust. However the load limits according to the following table should not be exceeded!
- Depending on the type of load receptacle, the static carrying capacity, i.e. the maximum admissible load is:

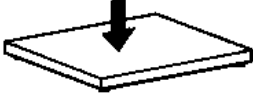
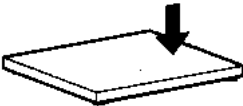
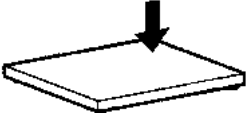
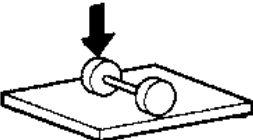
	<b>Weighing ranges</b>	<b>600kg</b>	<b>1500kg</b>	<b>3000kg</b>	<b>6000kg</b>
	With central load	900kg	2250kg	4500kg	9000kg
	With side stress	600kg	1500kg	3000kg	6000kg
	With one-sided loading	300kg	750kg	1500kg	3000kg
	With single-wheel load	600kg	1500kg	3000kg	6000kg

## 7.2 Operation with access ramps

- The load plate of the weighing bridge is an active weighing element, the access ramps are passive, i.e. during the weighing process all wheels of the conveying vehicles must rest on the load plate.
- The air gap between the load plate and the access ramps must be free. Especially for weighing of grainy or small-piece weighing goods, the gap should be controlled regularly and kept clear.

## 7.3 Load/unload weighing system

- Place the load on the scales using a lifting truck, a crane or a forklift truck. Ensure that the load is not swinging when it is placed onto the scales.
- Lift the load first vertically at least 10 cm above the scales before it is removed or newly placed.

## 8 Service, maintenance, disposal



Before any maintenance, cleaning and repair work disconnect the appliance from the operating voltage.

### 8.1 Daily check

- ⇒ Ensure that all four feet are in contact with the floor.
- ⇒ Ensure that the connecting cable to the display unit and the network connection cable of the display unit are not damaged.
- ⇒ Ensure that the balance is free from dirt, especially under the edges of the balance.

### 8.2 Cleaning

- ⇒ Remove regularly corrosive substances.
- ⇒ Keep IP protection.
- ⇒ Protect weighing cells against splash water.
- ⇒ When using optional ramps or foot plates, keep clean the air gap at the edge of the weighing bridge.
- ⇒ Wipe the surfaces with a damp cloth.
- ⇒ Only use common household cleaners.
- ⇒ Do not use water jet or high-pressure cleaner.

### 8.3 Service, maintenance

- ⇒ The appliance may only be opened by trained service technicians who are authorized by KERN.
- ⇒ Ensure that the weighing system is regularly calibrated, see chap. 3.5 Testing instruments control.

### 8.4 Disposal

- ⇒ Disposal of packaging and appliance must be carried out by operator according to valid national or regional law of the location where the appliance is used.

## 8.5 Instant help

In case of an error in the program process, briefly turn off the balance and disconnect from power supply. The weighing process must then be restarted from the beginning.

Help:

### Fault

### Possible cause

The displayed weight is permanently changing

- Draught/air movement
- Floor vibrations
- Weighing plate has contact with other objects.
- Electromagnetic fields / static charging (choose different location/switch off interfering device if possible)

The weighing result is obviously incorrect

- No zero display with unloaded balance
- Adjustment is no longer correct.
- Great fluctuations in temperature.
- Weighing bridge on an uneven surface.
- Electromagnetic fields / static charging (choose different location/switch off interfering device if possible)

Should other error messages occur, switch balance off and then on again. If the error message remains inform manufacturer.

## 9 Service documentation

- i**
- This chapter is only intended for a balance specialist!
  - The weighing bridges are carried out in DMS sensor technology, at every corner a DMS weighing cell is installed.
  - The analogue-digital transformation occurs in the display unit. Also all the balance and country-specific data are stored there.

### 9.1 Overview, setting regulation, tolerances

#### Testing and setting regulations:

Capacity	600 kg	1500 kg	3000 kg	6000 kg
Readability	200 g	500 g	1000 g	1000 g
Min	4 kg	10 kg	20 kg	40 kg
Max	600 kg	1500 kg	3000 kg	6000 kg
1/3 corner load	200 kg	500 kg	1000 kg	2000kg
Tolerance	200 g	500 g	1000 g	2000g

## Verification data and tolerances as per OIML

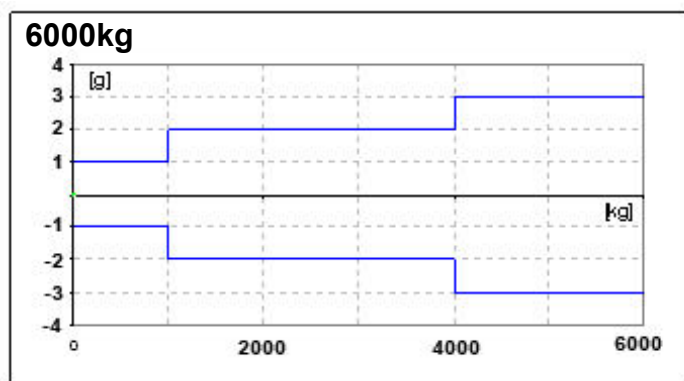
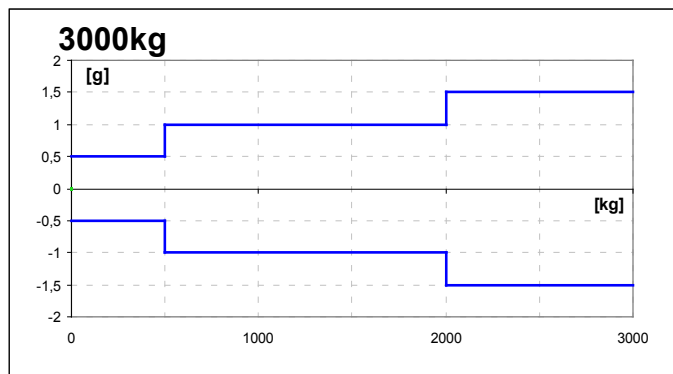
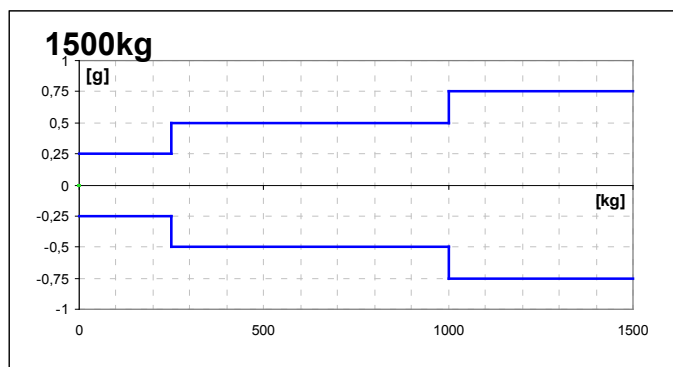
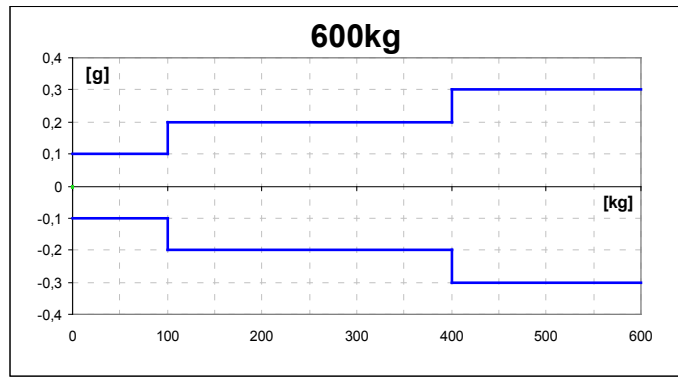

## 9.2 Check and adjustment of the corner load

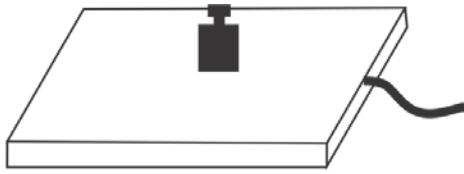

### Check of the corner load:

- Place the test weights in the centre of the load plate and tare.



0.00 kg

- The balance displays -0-.

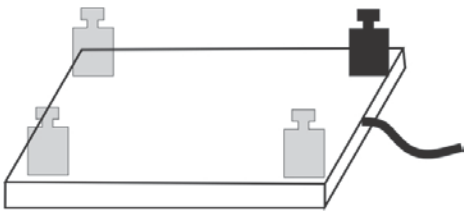

- Place the test weights successively on all four corners.
- Now the deviations are displayed with sign, write down the values. If there are deviations out of the tolerances (see chap. 9.1), an adjustment will be necessary.

### Adjustment of corner load:

#### Preparation:

- For a better control of the modifications which occur during adjustment, select in the configuration menu the highest readability for control purposes.
- Open connection box

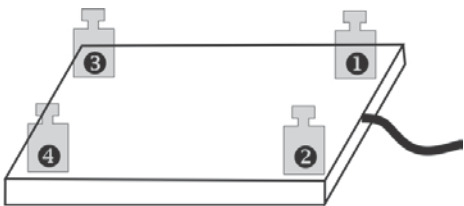

#### Adjustment rule:

The corner (weighing cell) with the biggest negative deviation must be set to zero. Do not re-adjust this corner even after several adjustment sequences.



## Adjustment on the analogue print

**i** This cabling description is only valid from serial number WF18xxxxx and up

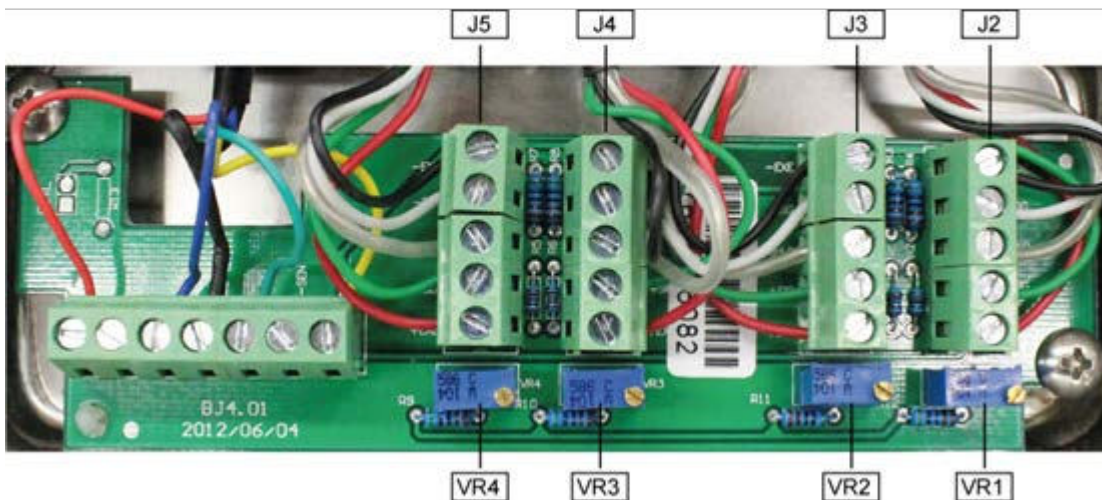
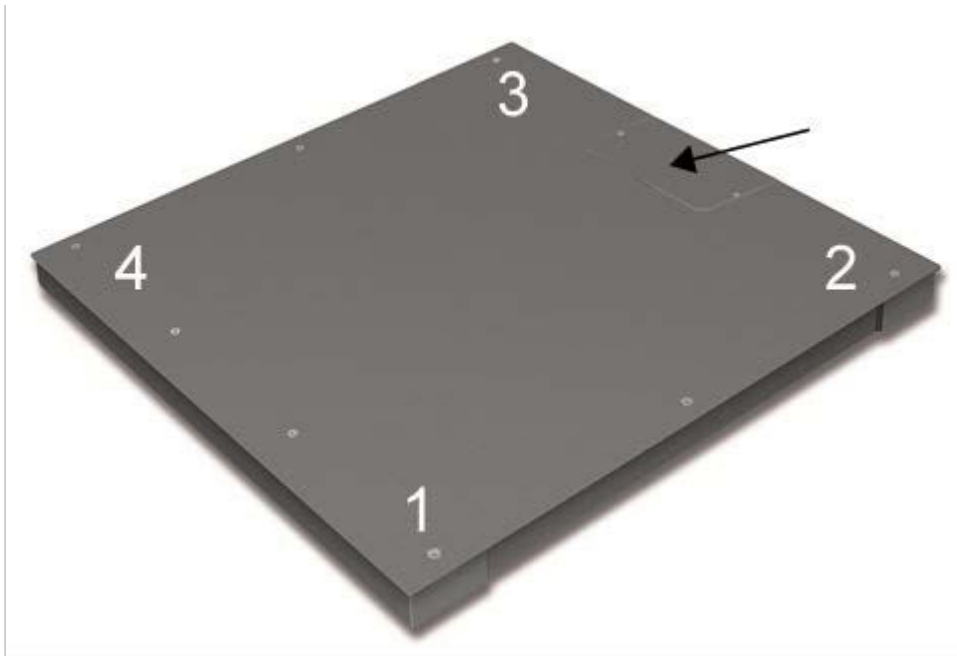

Adjustment of weighing cell 3 takes place at the potentiometer VR1.  
Adjustment of weighing cell 4 takes place at the potentiometer VR2.  
Adjustment of weighing cell 1 takes place at the potentiometer VR3.  
Adjustment of weighing cell 2 takes place at the potentiometer VR4.  
Increase the value turning to the right, reduce the value turning to the left.

## 10 Deadload and Overload settings

<b>Kern model</b>	<b>max. Preload* (kg)</b> * = additional initial load	<b>Center Overload Protection circa (kg)</b>	<b>Corner Overload Protection circa (kg)</b>	<b>Loadcell Capacity (kg)</b>
KFP 600V20SNM	90	NA	N/A	500kg
KFP 600V20NM	120	NA	N/A	500kg
KFP 1500V20SNM	90	NA	N/A	1000kg
KFP 1500V20NM	120	NA	N/A	1000kg
KFP 3000V20NM	120	NA	N/A	1500kg
KFP 3000V20LNM	150	NA	N/A	1500kg

<b>Platform type</b>	<b>Platform dimension (mm)</b>	<b>Loadcell Type</b>	<b>TC No.</b>	<b>Class</b>	<b>E<sub>max</sub> -1 (kg)</b>	<b>E<sub>min</sub> -4 (g)</b>	<b>Y</b>	<b>n -3</b>	<b>Dead-load (kg)</b>	<b>T<sub>min</sub> -5</b>	<b>T<sub>max</sub> -6</b>	<b>Cable-length (m)</b>
KFP 600V20SNM	1000x1000x80	CZL-8C-0.5T	D09-03.19	C3	500	0	10000	3000	90kg	-10	40	5
KFP 600V20NM	1500x1250x80	CZL-8C-0.5T	D09-03.19	C3	500	0	10000	3000	120kg	-10	40	5
KFP 1500V20SNM	1000x1000x80	CZL-8C-1T	D09-03.19	C3	1000	0	10000	3000	90kg	-10	40	5
KFP 1500V20NM	1500x1250x80	CZL-8C-1T	D09-03.19	C3	1000	0	10000	3000	120kg	-10	40	5
KFP 3000V20NM	1500x1250x80	CZL-8C-1.5T	D09-03.19	C3	1500	0	10000	3000	120kg	-10	40	5
KFP 3000V20LNM	1500x1500x80	CZL-8C-1.5T	D09-03.19	C3	1500	0	10000	3000	150kg	-10	40	5