

Operating manual

Pallet scale

KERN UIB

Version 1.0
09/2017
D



UIB-BA-e-1710



KERN UIB

Version 1.0 2017-09

Operating instructions Pallet scale

Contents

1	Technical data	4
1.1	Dimensions.....	5
2	Declaration of conformity	5
3	Appliance overview	6
3.1	Components	6
3.2	Operating elements	8
3.2.1	Overview of display.....	8
3.3	Keyboard overview	9
4	Basic Information (General)	9
4.1	Proper use	9
4.2	Improper Use	9
4.3	Warranty.....	10
4.4	Monitoring of Test Resources	10
5	Basic Safety Precautions	11
5.1	Pay attention to the instructions in the Operation Manual	11
5.2	Personnel training.....	11
6	Transport and storage	11
6.1	Testing upon acceptance.....	11
6.2	Packaging / return transport.....	11
7	Unpacking, Setup and Commissioning	12
7.1	Installation Site, Location of Use	12
7.2	Unpacking and placing.....	13
7.3	Adjustment.....	14
7.4	Checking and adjustment of the corner load	16
7.5	Load/unload the U-weighing bridge.....	18
7.6	Mains connection.....	19
7.7	Battery operation	19
7.8	Initial Commissioning	19

8	Operation	20
8.1	Start-up.....	20
8.2	Switching Off	20
8.3	Taring	21
8.4	Hold function (animal weighing function).....	22
8.5	Determination of the number of pieces	23
9	Menu	24
9.1	Navigation in the menu	24
9.2	Menu overview.....	25
10	Servicing, maintenance, disposal	26
10.1	Daily checks	26
10.2	Cleaning	26
10.3	Servicing, maintenance.....	26
10.4	Disposal.....	26
11	Error messages, troubleshooting guide	26

1 Technical data

KERN	UIB 600K-1	UIB 1.5T-4	UIB 3T-3
Readability (d)	0,2 kg	0,5 kg	1 kg
Weighing range (max)	600 kg	1500 kg	3000 kg
Reproducibility	0,2 kg	0,5 kg	1 kg
Linearity	± 0,2 kg	± 0,5 kg	± 1 kg
Recommended adjustment weight, not added (class)	600 kg (M2)	1.5t (M2)	3000 kg (M2)
Warm-up time	10 min.		
Stabilization time (typical)	2 s		
Weighing unit	kg, g, lb,oz		
Auto Off	3 min.		
Ambient temperature	-10°C – 40°C		
Humid environment	10 %- 95 % (non-condensing)		
Electric Supply	Input voltage 100 V - 240 V, 50 / 60 Hz, 0,3 A		
	Power pack secondary voltage 12V, 500mA		
Dimensions display unit (B x D x H) mm	260 x 115 x 70		
Weighing surface mm	840 x 1190		
Net weight kg	51 kg		
Cable length	5 m		
Material platform	powder-coated steel		

1.1 Dimensions

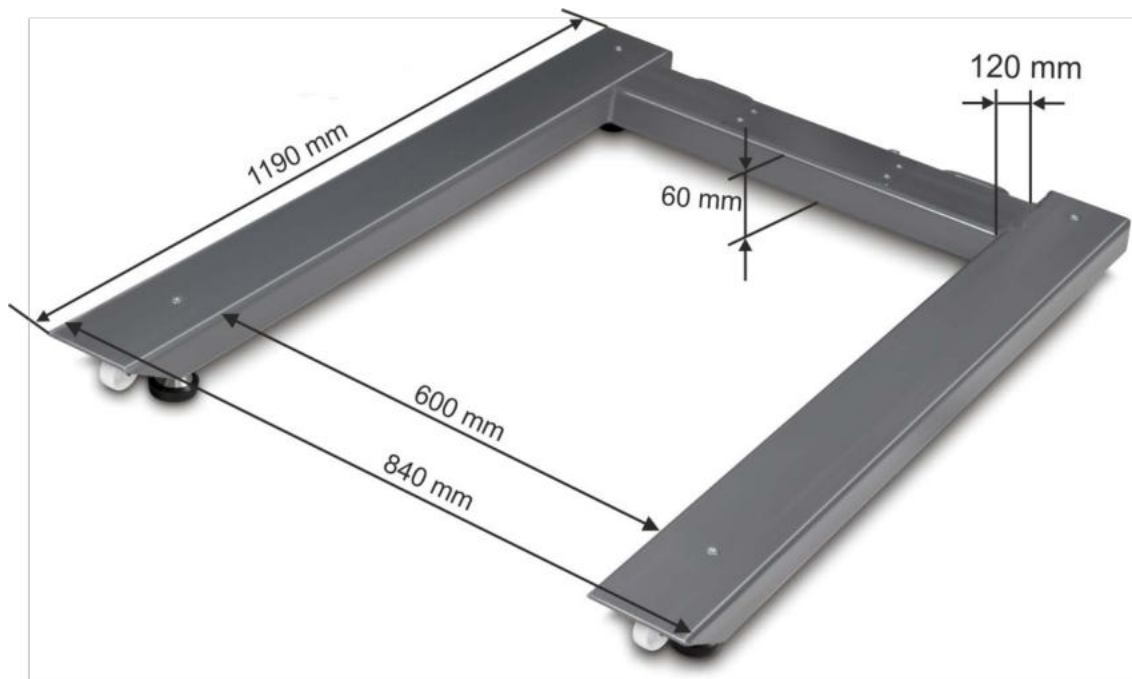

2 Declaration of conformity

The current EC/EU Conformity declaration can be found online in:

www.kern-sohn.com/ce

3 Appliance overview

3.1 Components

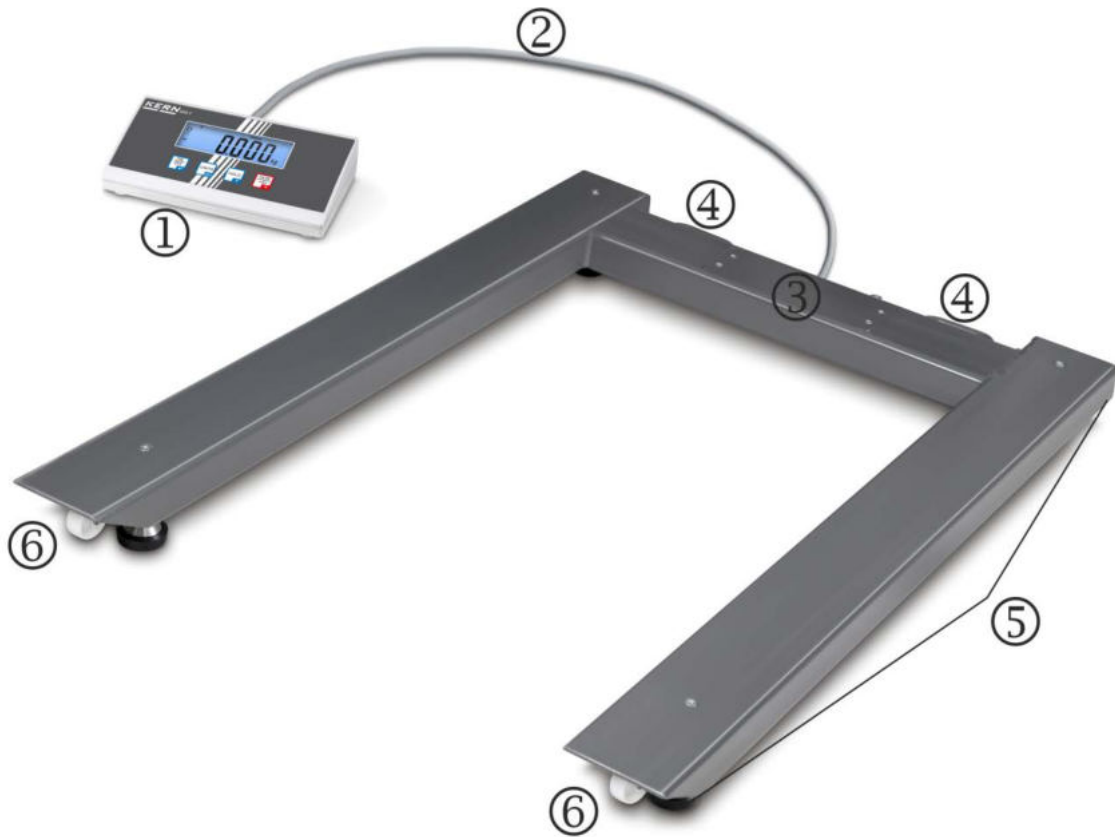

- ① Display unit
- ② Load cell cable
- ③ Connection box
- ④ Holding grip for comfortable transport
- ⑤ Weighing cell feet and weighing cells
- ⑥ Rollers

Display unit:

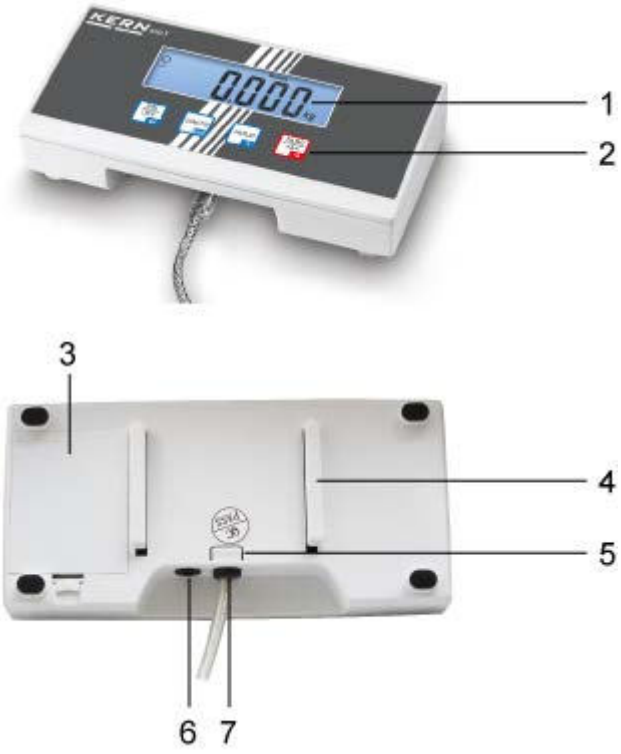

- 1. Weight display
- 2. Buttons
- 3. Battery compartment
- 4. Guide rail support base / stand
- 5. End stop support base / stand
- 6. Mains adapter connection
- 7. Connection load cell cable



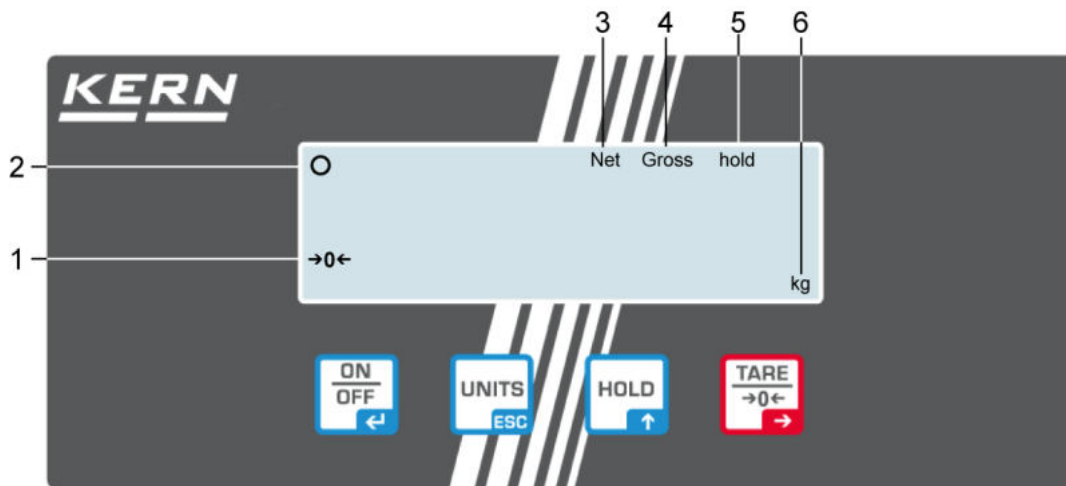

3.2 Operating elements

3.2.1 Overview of display



Nr.	Description
1	Balance zero display: Should the balance not display exactly zero despite empty scale pan, press the TARE button. The balance will be set to zero after a short standby time.
2	Stability display: If the display shows the stability display [0] the balance is in a stable status. If the status is instable the [0] display disappears.
3	Stored tare value, see chap. 8.3 „Taring“
4	Gross weight display: If the gross weight [Gross] appears in the display, the gross weight of the object and weighing container are displayed.
5	Hold/animal weighing function active
6	Weighing unit [kg ↔ lb]

3.3 Keyboard overview

Button	Function
	Turn on/off balance
	Hold/ animal weighing function
	Tare balance
	Switch-over weighing unit Back to weighing mode, or to menu

4 Basic Information (General)

4.1 Proper use

The balance you purchased is intended to determine the weighing value of material to be weighed. It is intended to be used as a “non-automatic balance”, i.e. the material to be weighed is manually and carefully placed in the centre of the weighing pan. As soon as a stable weighing value is reached the weighing value can be read.

4.2 Improper Use

Do not use balance for dynamic add-on weighing procedures, if small amounts of goods to be weighed are removed or added. The “stability compensation“ installed in the balance may result in displaying an incorrect measuring value! (Example: Slowly draining fluids from a container on the balance.)

Do not leave permanent load on the weighing pan. This may damage the measuring system.

Impacts and overloading exceeding the stated maximum load (max) of the balance, minus a possibly existing tare load, must be strictly avoided. Balance may be damaged by this.

Never operate balance in explosive environment. The serial version is not explosion protected.

The structure of the balance may not be modified. This may lead to incorrect weighing results, safety-related faults and destruction of the balance.

The balance may only be used according to the described conditions. Other areas of use must be released by KERN in writing.

4.3 Warranty

Warranty claims shall be voided in case

- Our conditions in the operation manual are ignored
- The appliance is used outside the described uses
- The appliance is modified or opened
- Mechanical damage or damage by media, liquids, natural wear and tear
- The appliance is improperly set up or incorrectly electrically connected
- The measuring system is overloaded

4.4 Monitoring of Test Resources

In the framework of quality assurance the measuring-related properties of the balance and, if applicable, the testing weight, must be checked regularly. The responsible user must define a suitable interval as well as type and scope of this test. Information is available on KERN's home page (www.kern-sohn.com) with regard to the monitoring of balance test substances and the test weights required for this. In KERN's accredited DKD calibration laboratory test weights and balances may be calibrated (return to the national standard) fast and at moderate cost.

5 Basic Safety Precautions

5.1 Pay attention to the instructions in the Operation Manual



Carefully read this operation manual before setup and commissioning, even if you are already familiar with KERN balances.

5.2 Personnel training

The appliance may only be operated and maintained by trained personnel.

6 Transport and storage

6.1 Testing upon acceptance

When receiving the appliance, please check packaging immediately, and the appliance itself when unpacking for possible visible damage.

6.2 Packaging / return transport



- ⇒ Keep all parts of the original packaging for a possibly required return.
- ⇒ Only use original packaging for returning.
- ⇒ Prior to dispatch disconnect all cables and remove loose/mobile parts.
- ⇒ Reattach possibly supplied transport securing devices.
- ⇒ Secure all parts such as the glass wind screen, the weighing pan, power unit etc. against shifting and damage.

7 Unpacking, Setup and Commissioning

7.1 Installation Site, Location of Use

The balances are designed in a way that reliable weighing results are achieved in common conditions of use.

You will work accurately and fast, if you select the right location for your balance.

Therefore, observe the following for the installation site:

- Place the weighing system on a firm, level surface;
The foundation at the installation site must be able to carry the weight of the weighing system as well as the weight of the maximum load.
- Avoid extreme heat as well as temperature fluctuation caused by installing next to a radiator or in the direct sunlight;
- Protect the weighing system against direct draughts due to open windows and doors;
- Avoid jarring during weighing
- Protect the weighing system against high humidity, vapours and dust;
- Do not expose the device to extreme dampness for longer periods of time.
Non-permitted condensation (condensation of air humidity on the appliance) may occur if a cold appliance is taken to a considerably warmer environment.
In this case, acclimatize the disconnected appliance for ca. 2 hours at room temperature.
- Avoid static charge of goods to be weighed or weighing container.
- Do not lean the weighing system against the wall.
- Do not move the weighing system when it is loaded.
- Keep away chemical substances such as liquids or gases which may attack or damage the weighing system inside or outside.

If electro-magnetic fields or static charge occur, or if the power supply is unstable major deviations on the display (incorrect weighing results) are possible. In that case, the location must be changed.

7.2 Unpacking and placing



CAUTION

Danger for the back!

The weighing system is quite heavy. Always use an according lifting device to lift it out of the packaging or to transport it to the required placement site

Unpacking:

- ⇒ Remove the outer packaging.
- ⇒ Lift the weighing system off the packaging material, see note of caution.
- ⇒ Secure the weighing system that it cannot fall down when it is lifted.
- ⇒ Make sure that the contents of the packaging is complete.

Scope of delivery:

- U-weighing bridge with assembled connection cable
- 4 weighing cell feet
- Instruction Manual

Placing:

Make sure that the surface of the placement site, especially around the weighing cell feet, is even. Small unevenness can be offset by adjustment of the weighing cell feet.

- ⇒ Before a final placement install the four weighing cell feet. For transporting lift-off the handle and move it on the conveyor rollers.
- ⇒ Settle down the weighing system and check if it is positioned evenly and all the four feet touch the floor. Remove the covering screw and carry out adjustment if necessary by turning the adjustment screw on the four weighing cells.











- ① Position adjustment screw of the weighing cell feet
- ② Position of weighing cell

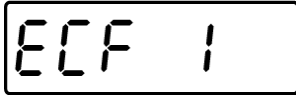

- ⇒ Make sure that during lifting and settling the connection cable is not squeezed or damaged.

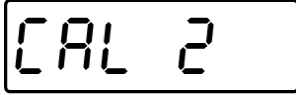
7.3 Adjustment

As the acceleration value due to gravity is not the same at every location on earth, each balance must be coordinated - in compliance with the underlying physical weighing principle - to the existing acceleration due to gravity at its place of location (only if the balance has not already been adjusted to the location in the factory). This adjustment process must be carried out for the first commissioning, after each change of location as well as in case of fluctuating environment temperature. To receive accurate measuring values it is also recommended to adjust the balance periodically in weighing operation.

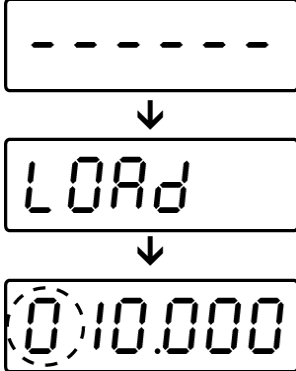
Observe stable environmental conditions. A warming up time (see chapter 1) is required for stabilization.

<p>Press  and  at the same time in weighing mode. [ECF 1] is displayed.</p>	
<p>(The adjustment process can be exited at any time with . The balance returns then to weighing mode.)</p>	
<p>Confirm display of [ECF 1] with . [CAL Z] is displayed.</p>	
<p>Acknowledge with . [-----] followed by [LOADⁱ] will be displayed briefly. Then the display to input the recommended adjustment weight is displayed (see chap. 1 "Technical data") The left digit flashes. Enter the value of the adjustment weight as follows: Switch to the next digit to the right with . Increase number with . Confirm the value entered with .</p>	 <p>(example)</p>

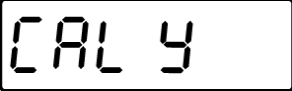
<p>The specified adjustment weight is displayed flashing.</p>	 <p>(example)</p>
<p>Place the adjustment weight centrally on the weighing pan and confirm with . "CAL Y" will flash briefly and a signalling tone will sound. Adjustment will be performed. Then the balance returns automatically into the weighing mode.</p>	

i An error message will be displayed in the event of an adjustment error or incorrect adjustment weight. Remove the adjustment weight and repeat the adjustment process.

Keep the adjustment weight close to the balance. Daily control of the weighing exactness is recommended for quality-relevant applications.

7.4 Checking and adjustment of the corner load

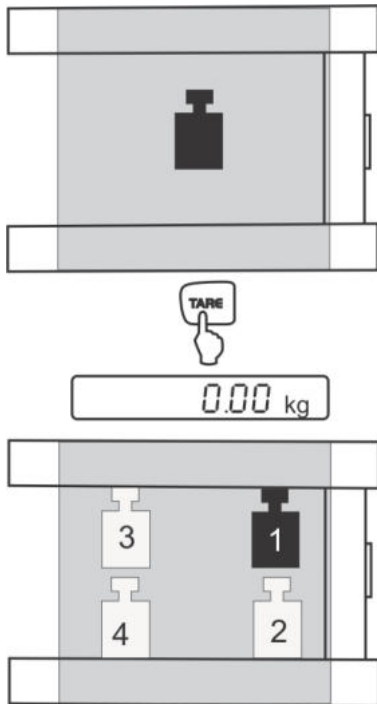

Checking the corner load

- Put pallet
- Put test weights in the centre on the pallet and tare.
- The balance displays -0-.
- Place the test weights subsequently at all four corners, observe order 1, 2, 3, 4.
- Now the divergences are displayed with sign, write down the values. If there are divergences beyond the tolerances (see chap. 9.1), an adjustment will be necessary.

Adjusting the corner load

Preparation:

- For a better control of the changes which are resulting during adjustment, select the highest readability for control purposes in the configuration menu.
- Open the connection box

Adjustment rule:

The corner (weighing cell) with the largest minus divergence must be set to zero. Do not misadjust this corner even after several adjustment cycles.

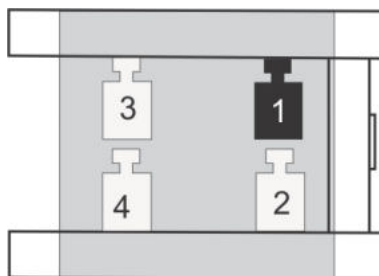

Adjustment at the analogue print

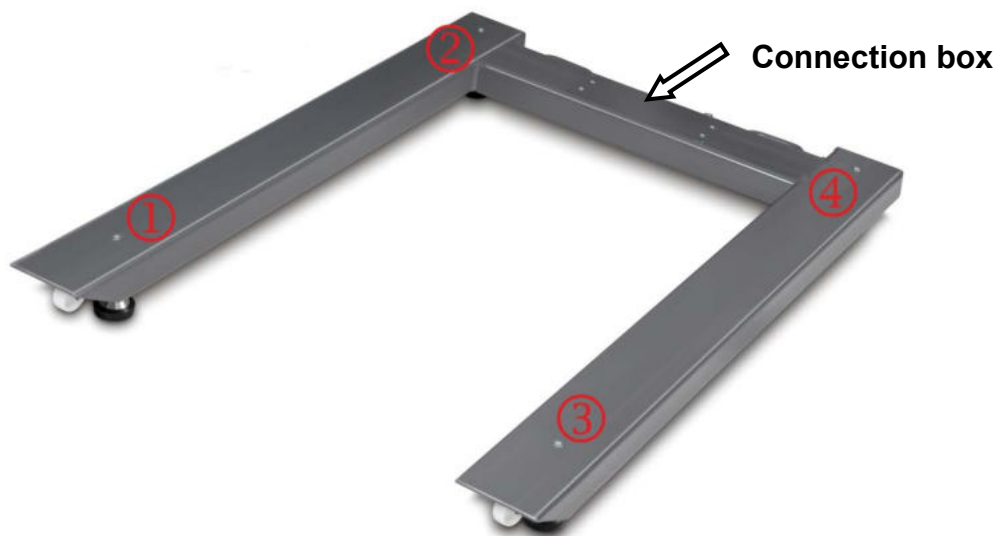

- ① Weighing cell 1
- ② Weighing cell 2
- ③ Weighing cell 3
- ④ Weighing cell 4

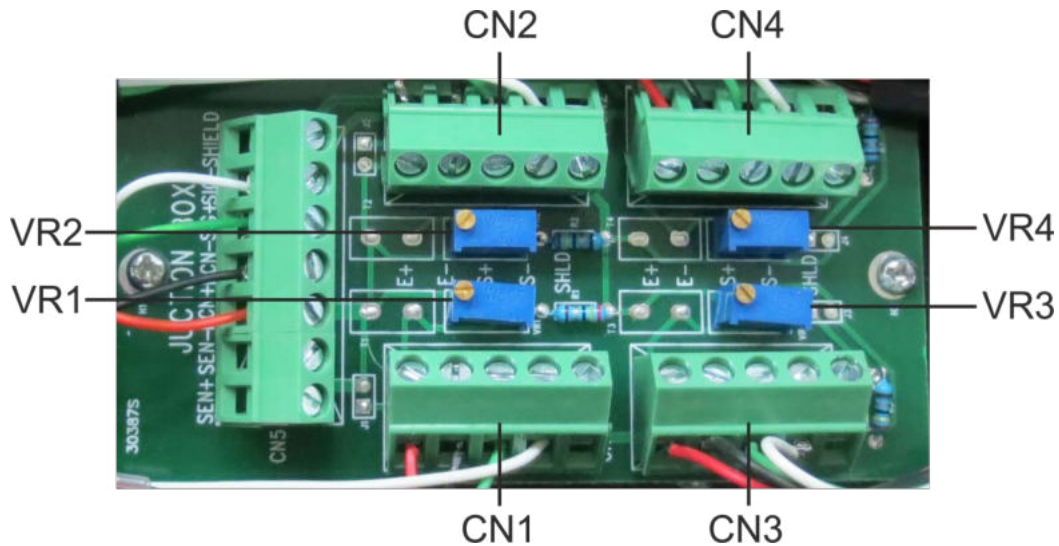

Adjustment of weighing cell CN1 takes place at the potentiometer VR1
Adjustment of weighing cell CN2 takes place at the potentiometer VR2
Adjustment of weighing cell CN3 takes place at the potentiometer VR3
Adjustment of weighing cell CN4 takes place at the potentiometer VR4
Increase the value turning to the right, reduce the value turning to the left.

7.5 Load/unload the U-weighing bridge

- ⇒ Place the load on the scales using a pallet lifting truck, a crane or a forklift truck. Ensure that the load is not swinging when it is placed onto the scales.
- ⇒ Lift the load first vertically at least 10 cm above the scales before it is removed or newly placed.

The U-weighing bridge is designed for an even distributed load.

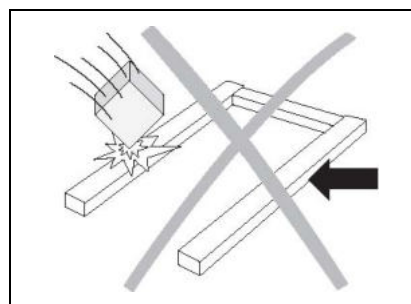
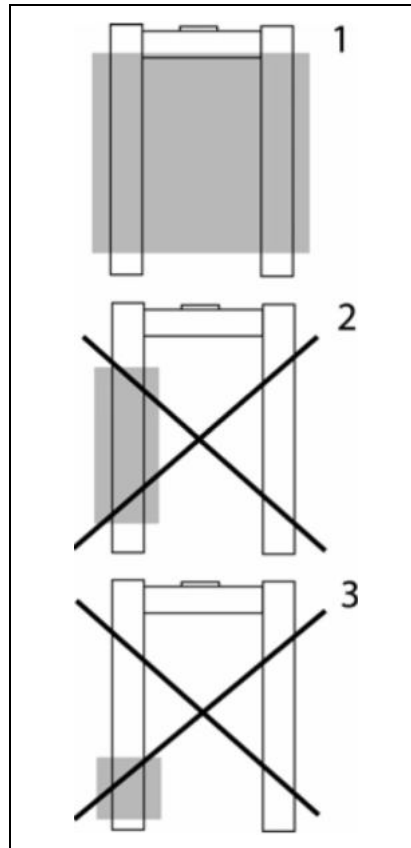

- Avoid falling load, shock loads and impacts from the side.
- The forks of the fork lift truck may not touch the pallet or the balance during weighing process.
- Do not move the balance at any moment, when it is loaded.

7.6 Mains connection



Select a country-specific power plug and insert it in the power unit.



Check, whether the voltage acceptance on the scales is set correctly. Do not connect the scales to the power grid unless the information on the scales (sticker) matches the local mains voltage.

Only use KERN original mains adapter. Using other makes requires consent by KERN.



Important:

- Before starting your weighing balance, check the mains cable for damage.
- Ensure that the power unit does not come into contact with liquids.
- Ensure access to power plug at all times.

7.7 Battery operation

On the rear side of the display unit remove the battery cover and connect 4 x 1.5V mignon cells. Reinsert the battery cover.

In order to save the battery, the balance switches automatically off after 3 minutes without weighing. Additional switch-off times can be set in the menu (function "A.OFF").

If the batteries are depleted, the battery symbol  is displayed.

Switch-off balance and replace batteries at once.

If the balance is not used for a longer time, take out the batteries and store them separately. Leaking battery liquid could damage the balance.



7.8 Initial Commissioning

In order to obtain exact results with the electronic balances, your balance must have reached the operating temperature (see warming up time chap. During this warming up time the balance must be connected to the power supply (mains, accumulator or battery).

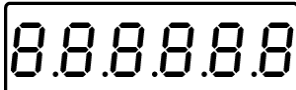

The accuracy of the balance depends on the local acceleration of gravity. Strictly observe hints in chapter Adjustment.

8 Operation





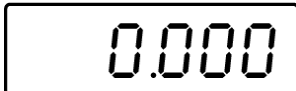

8.1 Start-up

<p>Start balance by pressing .</p> <p>The balance will carry out a self-test As soon as the weight display appears, the balance is ready for weighing.</p>	 ↓ 
<p>Should the balance not display exactly zero despite empty weighing pan, press the  button. The balance will be set to zero after a short standby time.</p>	

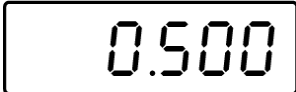
8.2 Switching Off

<p>Switch off balance with , the display will go off.</p>	 ↓ 
--	---

8.3 Taring

<p>Place an empty weighing container, the weight of the weighing container will be displayed.</p>	
<p>Press , the zero display appears. The indicator [NET] is displayed. The tare weight is saved until it is deleted.</p>	
<p>Weigh the material, the net weight will be indicated.</p> <p>The taring process can be repeated any number of times, e.g. when adding several components for a mixture (adding). The limit is reached when the whole weighing range is exhausted.</p> <p>After removing the weighing container, the weight of the weighing container appears as negative display.</p> <p>The tare weight is saved until it is deleted.</p>	
<p>Delete tare value:</p> <p>Unload the balance and press , zero display will appear.</p>	



8.4 Hold function (animal weighing function)

The balance has an integrated animal weighing function (mean value calculation). Using this function it is possible to weigh domestic or small animals exactly (min. load 1% of the max. one), although they do not stand quiet on the weighing pan.

Place weighing goods and press . The display will be blinking [-HOLD] and the indicator [hold] will be displayed. During this time the balance takes up several measured values and displays then the calculated mean value.

This value will be displayed until you press  again. The indicator [hold] turns off, the balance will return to the normal weighing mode.

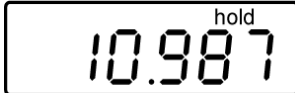
By pressing  again, this function can be repeated any number of times.



(example)











There is no average value calculation in the event of too much movement (heavy display oscillation).

8.5 Determination of the number of pieces



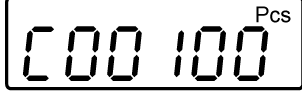

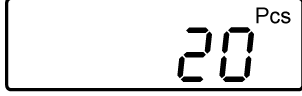



Before it is possible to determine the number of pieces by means of the scales, it is necessary to specify the average piece weight (unit weight), the so-called reference value. In order to do it, one shall place the specific number of pieces being counted up. By means of the scales, the total mass shall be determined which then will be divided by the number of pieces (the so-called reference pieces). Afterwards, based on the calculated average piece weight, counting up shall be carried out.

i The greater the number of reference pieces, the higher the accuracy of counting up.

<p>In the weighing module, by means of  button, set „Pcs” unit. The scales is now in the module allowing to determine the number of pieces.</p>	
<p>Keep pushing  button until the display shows „C00000”. The value after the comma blinks.</p> <p>The number of reference pieces may be entered in the way described below:</p> <ul style="list-style-type: none"> •  : Increasing the numerical value •  : Moving on to the next value after comma •  : Confirmation of the entered number of reference pieces 	
<p>Enter the number of reference pieces in the way described above. Here, for example 100 pieces. Digit "1" blinks.</p>	 <p>(example)</p>
<p>Place the pieces to be counted up on the scales and confirm by means of pushing  button. The number of pieces shall be displayed.</p>	

9 Menu

9.1 Navigation in the menu

- ⇒ Press  and  at the same time in weighing mode. [UF 1] is displayed.
- ⇒ Press  as often as necessary until the required function is displayed.
- ⇒ Confirm selected function by . The current setting will be displayed. Select the desired parameter with  . Return to menu by .
- ⇒ Press  to exit the menu. The balance returns automatically into weighing mode.

9.2 Menu overview

UF-1	- 1630 (example)	Internal value not documented	
UF-2	RoFF 10 *	Auto-Off Automatic shutdown function Can be set between 1-99 minutes	
UF-3		Display background illumination Adjustable:	
	Lit on	Background lighting on	
	Lit off	Background lighting off	
	Lit A *	Backlight automatically off	
UF-4		Hold function (animal weighing function) Adjustable:	
	Hd 20d	Average value is calculated for unstable weighing conditions from approx. 20 d	
	Hd 5d	Average value is calculated for unstable weighing conditions from approx. 5 d	
	Hd 10d *	Average value is calculated for unstable weighing conditions from approx. 10 d	
UF-5	ZP 0 ↓ ZP 5	Auto Zero Adjustable:	
		ZP 0 *	Auto Zero: Off
		ZP 1	• 0.5 d/s
		ZP 2	• 1 d/s
		ZP 3	• 2 d/s
		ZP 4	• 3 d/s
		ZP 5	• 5 d/s
UF-6	9.79450 *	G-value (value of the local gravitational acceleration) Adjustable	

i Factory settings are marked by *.

10 Servicing, maintenance, disposal



Before cleaning, disconnect the appliance from the operating voltage.

10.1 Daily checks

- ⇒ Ensure that all the four feet touch the floor.
- ⇒ Ensure that the connection cable to the display unit and the mains connection cable of the display unit are not damaged.
- ⇒ Make sure that the balance is free of dirt, especially under the edges of the balance.

10.2 Cleaning

Please do not use aggressive cleaning agents (solvents or similar agents), but a cloth dampened with mild soap suds. Take care that the device is not penetrated by fluids and polish it with a dry soft cloth.

Loose residue sample/powder can be removed carefully with a brush or manual vacuum cleaner.

10.3 Servicing, maintenance

The appliance may only be opened by trained service technicians who are authorized by KERN.

Before opening, disconnect from power supply.

10.4 Disposal

Disposal of packaging and appliance must be carried out by operator according to valid national or regional law of the location where the appliance is used.

11 Error messages, troubleshooting guide

Error message

Possible cause

o-Err

- Weighing range exceeded

u-Err

- Insufficient preload, e. g. missing weighing pan

b-Err

- Missing internal memory

1-Err

- Incorrect adjusting weight

2-Err

- Inappropriate adjustment

I-Err

- Item weight too low

In case of an error in the program process, briefly turn off the balance and disconnect from power supply. The weighing process must then be restarted from the beginning.

Help:

Fault

Possible cause

The displayed weight does not glow.

- The balance is not switched on.
- The mains supply connection has been interrupted (mains cable not plugged in/faulty).
- Power supply interrupted.

The displayed weight is permanently changing

- Draught/air movement
- Table/floor vibrations
- The weighing pan is in contact with foreign matter.
- Electromagnetic fields / static charging (choose different location/switch off interfering device if possible)

The weighing value is obviously wrong

- The display of the balance is not at zero
- Adjustment is no longer correct.
- The balance is on an uneven surface.
- Great fluctuations in temperature.
- Electromagnetic fields / static charging (choose different location/switch off interfering device if possible)

Should other error messages occur, switch balance off and then on again. If the error message remains inform manufacturer.
