

Operating instructions Electronic Crane Scales

Logbook Regular maintenance and care

KERN HFO

Version 1.3
2020-04
GB



HFO-BA-e-2013



KERN HFO

Version 1.3 2020-04

Operating instructions / logbook Electronic Crane Scales

Contents

1.	Technical data	4
1.1	Dimensions	5
1.2	Nameplate	6
1.3	EC-Declaration of -Conformity	7
2.	General Safety Instructions	8
2.1	Duties of an owner-operator	8
2.2	Organizational measures	8
2.3	Environmental conditions	9
2.4	Pay attention to the instructions in the Operation Manual	9
2.5	Intended use	9
2.6	Intended use of rotating load hooks	10
2.7	Improper Use	10
2.8	Warranty	10
2.9	Safe working	10
2.10	Monitoring of Test Resources	11
2.11	Testing upon acceptance	11
2.12	Initial Commissioning	11
2.13	Shutdown and storage	11
3.	Appliance overview	12
3.1	Overview	12
3.2	Display	13
3.3	Keyboard	14
3.4	Radio remote control	15
3.5	Label	16
4.	Commissioning	17
4.1	Unpacking	17
4.2	Before first use check the dimensions and note them down on the checklist	17
4.3	Rechargeable battery operation	18
4.4	Standby mode (sleep mode)	19
4.5	Suspending the balance	20
5.	Operation	21
5.1	Safety instructions	21
5.2	Loading the crane scales	22
5.3	Turn on/off	25
5.4	Balance zeroing	25
5.5	Taring	26
5.6	Weighing	26
5.7	Sleep function (standby function)	26
6.	Menu	27

6.1	Navigation in the menu _____	27
6.2	Overview: _____	28
7.	Adjustment _____	29
7.1	Adjustment _____	29
7.2	Verification _____	31
7.3	Position of adjustment switch _____	31
8.	Error messages _____	32
9.	Cleaning, Repair, Maintenance and Disposal _____	33
9.1	Cleaning and Disposal _____	33
9.2	Regular maintenance and care _____	34
9.3	Checklist „regular maintenance“ _____	35
9.4	Maintenance table _____	36
9.5	Drawings of a hook, shackle and crane scale _____	37
9.6	Inspection cycles _____	38
9.7	Drawing with “h” dimension _____	39
10.	Enclosure _____	40
10.1	Checklist „Enhanced maintenance“ (General revision) _____	40
10.2	List „spare parts and repair of safety-relevant parts“ _____	41
11.	Instant help _____	43

1. Technical data

KERN	HFO 1.5T0.5M	HFO 3T1M	HFO 6T2M
Readability (d)	0.5 kg	1 kg	2 kg
Weighing range (max)	1500 kg	3000 kg	6000 kg
Taring range (subtractive)	1500 kg	3000 kg	6000 kg
Reproducibility	500 g	1 kg	2 kg
Linearity	± 500 g	± 1 kg	± 2 kg
Recommended adjustment weight, not added (class)	1.5 t (M1)	3 t (M1)	6 t (M1)
Stabilization time	2 s		
Precision	0.5 % of max.		
Warm-up time	10 min		
Unit	kg		
Allowable ambient temperature	-10...+40 °C		
Relative humidity	0 to 80 %, non-condensing		
Input voltage Appliance	12 V, 500 mA		
Input voltage Mains adapter	220V - 240V AC, 50 Hz		
Rechargeable battery (standard equipment)	6 V, 10 Ah Service life, background illumination ON 50 h Loading time 14 h		
Display	Digit height 30 mm		
Display housing dimensions Width x Depth x Height, (mm)	270 x 175 x 200		
Housing material	Cast iron		
Material display housing	Cast aluminium		
Material lifting hook	Painted steel		
Net weight (kg)	15.6	16.5	30
Remote control (standard equipment), wireless	Battery Size 23A (1 x 12 V)		

1.1 Dimensions

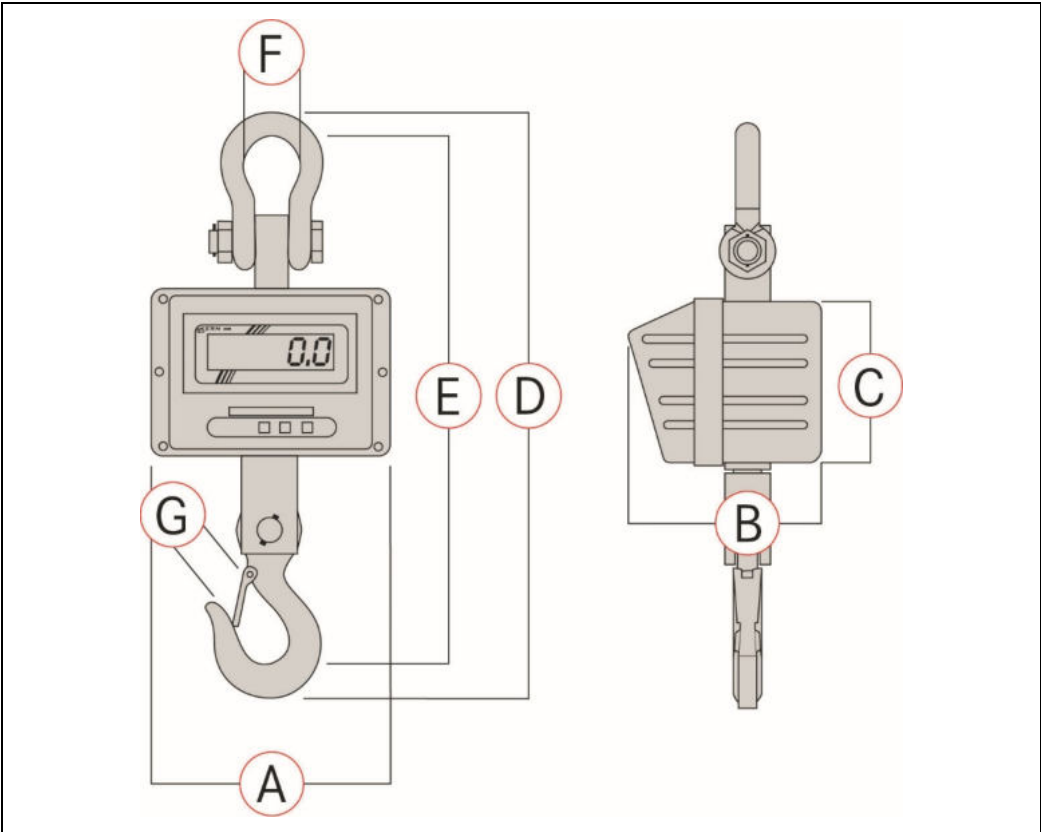

	A	B	C	D	E	F	G
	mm	mm	mm	mm	mm	mm	mm
HFO 1.5T0.5M	270	175	200	610	540	60	35
HFO 3T1M	270	175	200	610	540	80	47
HFO 6T2M	300	190	230	730	650	80	54,4

1.2 Nameplate



①	KERN Logo
②	Model designation
③	Weighing range [Max]
④	Data for power supply
⑤	Company address
⑥	Readability [d]
⑦	Date of manufacture
⑧	CE mark
⑨	Disposal symbol
⑩	Serial number

1.3 EC-Declaration of -Conformity



KERN & Sohn GmbH
Ziegelei 1
72336 Balingen-Frommern
Germany

www.kern-sohn.com
+0049-[0]7433-9933-0
+0049-[0]7433-9933-149
info@kern-sohn.com

Déclaration de conformité UE | EU Declaration of Conformity | EU-Konformitätserklärung

FR Nous déclarons par la présente sous notre entière responsabilité que le produit concerné par cette déclaration respecte les exigences des directives mentionnées ci-après.

EN We hereby declare and assume sole responsibility for the declaration that the product complies with the directives hereinafter.

DE Wir erklären hiermit unter alleiniger Verantwortung, dass das Produkt, auf das sich diese Erklärung bezieht, mit den nachstehenden Richtlinien übereinstimmt.

Type | Type | Typ

N° de série | Serial no. | Seriennr.

HFO 1.5T0.5M, HFO 3T1M, HFO 6T2M

XXXXXXXXXX

Marquage CE Mark applied CE Kennzeichnung	Directive UE EU directive EU-Richtlinie	Normes Standards Normen
	2006/42/EC (MD)	EN 13155:2003/A2:2009
	2011/65/EU (RoHS)	EN 50581:2012
	2014/30/EU (EMC)	EN 55022:2010 EN 55024:2010 EN 61000-3-3:2013
	2014/35/EU (LVD)	EN 60065:2014 EN 60950-1:2006/A2:2013

Date | Date | Datum: 20.04.2016

Lieu de délivrance: 72336 Balingen,
Place of issue: Germany

Ort der Ausstellung:

Albert Sauter
KERN & Sohn GmbH

Signature: Directeur Exécutif
Signature: Managing director
Signatur: Geschäftsführer



Further language versions you will find online under:

www.kern-sohn.com/ce

2. General Safety Instructions

2.1 Duties of an owner-operator

Follow national accident prevention regulations and all operator health and safety at work and operating regulations.

- Observe all safety regulations of the crane manufacturer.
- The balance may only be used for the proposed purpose. Any type of use which is not specified in these operating instructions, will be considered as improper use. The customer is solely responsible for material damage and injury of persons resulting from an improper use, Messrs. KERN & Sohn will not be liable under any circumstance.
Messrs . KERN & Sohn cannot be held liable, if the crane scales are modified or used improperly and if damage is resulting from such use.
- Carry out regular maintenance and care of the crane scales, the crane and the load suspension devices (see chapter 9).
- Log the test result and keep it in the logbook.

2.2 Organizational measures

- Only trained and instructed staff may operate the balance.
- Make sure that the operating instructions are kept nearby the operation site of the crane scales.
- Assembly, commissioning and maintenance should only be carried out by trained specialists.
- Repair of safety-relevant pieces may only be carried out by the company OH&S specialist
- Use original spare parts only.
- All repairs and spare parts must be documented by the service partner (see list, chap. 10.2).
- All maintenance must be documented (see checklist chap. 9.3).
- Load suspending components may only be exchanged as a complete spare parts set. The dimensions of the new components must be noted (see checklist chapter 9.3).

2.3 Environmental conditions

- Never operate the crane scales in explosive environment. The serial version is not explosion protected.
- Operate the crane scales only under environmental conditions as specified in these operating instructions (especially in chapter 1 „Technical data“).
- Do not expose the crane scales to strong humidity. Non-permitted condensation (condensation of air humidity on the appliance) may occur if a cold appliance is taken to a considerably warmer environment. In this case, acclimatize the disconnected appliance for ca. 2 hours at room temperature.
- Do not operate the crane scales in corrosive environment.
- Protect the crane scales against high humidity, vapours and dust.
- Avoid extreme heat as well as temperature fluctuation e.g. caused by direct sun light.
- Major display deviations (incorrect weighing results) may be experienced should electromagnetic fields (e.g. due to mobile phones or radio equipment), static electricity accumulations or instable power supply occur. Change location or remove source of interference.

2.4 Pay attention to the instructions in the Operation Manual



Carefully read this operation manual before setup and commissioning, even if you are already familiar with KERN balances.

2.5 Intended use

The balance you purchased is intended to determine the weighing value of material to be weighed. It is intended to be used as a “non-automatic” balance, i.e. the material to be weighed is suspended on the crane hook only vertically, manually, carefully and without jerks. As soon as a stable weighing value is reached the weighing value can be read.

- Use the crane scales only for lifting and weighing of freely movable loads.
- Danger of injury due to improper use. Not allowed are e.g.
 - Exceeding the allowed nominal load of crane, crane scales or any type of load attachment devices
 - Conveying persons,
 - Pulling loads over an inclined surface,
 - Tearing-off, pulling or towing loads.
- Modifications or reconstructions of the crane scales or of the crane are not allowed.

2.6 Intended use of rotating load hooks

- The rotatable load hook has been provided for a simple and comfortable hooking of the weighed material.
- The rotating function of the load hook under load is out of function. The load on the crane scales must not be swiveled. Any turning movement must be done by a rotatable crane hook. A loaded crane scale generally must not be rotated. (static loading and unloading of a load).

2.7 Improper Use

Do not use balance for dynamic weighing. In the event that small quantities are removed or added to the material to be weighed, incorrect weighing results can be displayed due to the "stability compensation". (Example: Slowly draining fluids from a container suspended on the balance.) Do not leave permanent load suspended on the balance. This may damage the measuring system as well as safety-relevant parts.

The balance may only be used according to the described conditions. Other areas of use must be released by KERN in writing.

2.8 Warranty

Warranty claims shall be voided in case

- Our conditions in the operation manual are ignored
- The appliance is used outside the described uses
- The appliance is modified or opened
- Mechanical damage and damage caused by media, liquids,
- Natural wear and tear
- The appliance is improperly set up or incorrectly electrically connected
- The measuring system is overloaded

2.9 Safe working

- Do not stand underneath suspended loads!
- Position the crane in a way that the load is lifted vertically.
- When working with the crane and crane scales wear personal safety equipment (helmet, safety shoes etc.).

2.10 Monitoring of Test Resources

In the framework of quality assurance the measuring-related properties of the balance and, if applicable, the testing weight, must be checked regularly. The responsible user must define a suitable interval as well as type and scope of this test. Information is available on KERN's home page (www.kern-sohn.com) with regard to the monitoring of balance test substances and the test weights required for this. In KERN's accredited DKD calibration laboratory test weights and balances may be calibrated (return to the national standard) fast and at moderate cost.

2.11 Testing upon acceptance

When receiving the appliance, please check packaging immediately, and the appliance itself when unpacking for possible visible damage.

2.12 Initial Commissioning

In order to obtain exact results with the electronic balances, your balance must have reached the operating temperature (see warming up time chap. 1).

During this warming up time the balance must be connected to the power supply (mains, accumulator or battery).

The accuracy of the balance depends on the local acceleration of gravity.

Strictly observe hints in chapter Adjustment.

For checking original dimensions, s. chap. 4.2

2.13 Shutdown and storage

- Take off the crane scales from the crane and dismantle all load attachment devices from the crane scales.
- Do not store the crane scales at open air

3. Appliance overview

The crane scales are a multi-purpose and cost-saving solution for overhead weighing applications such as e.g. recycling, metal processing, machine engineering, transport and logistics.

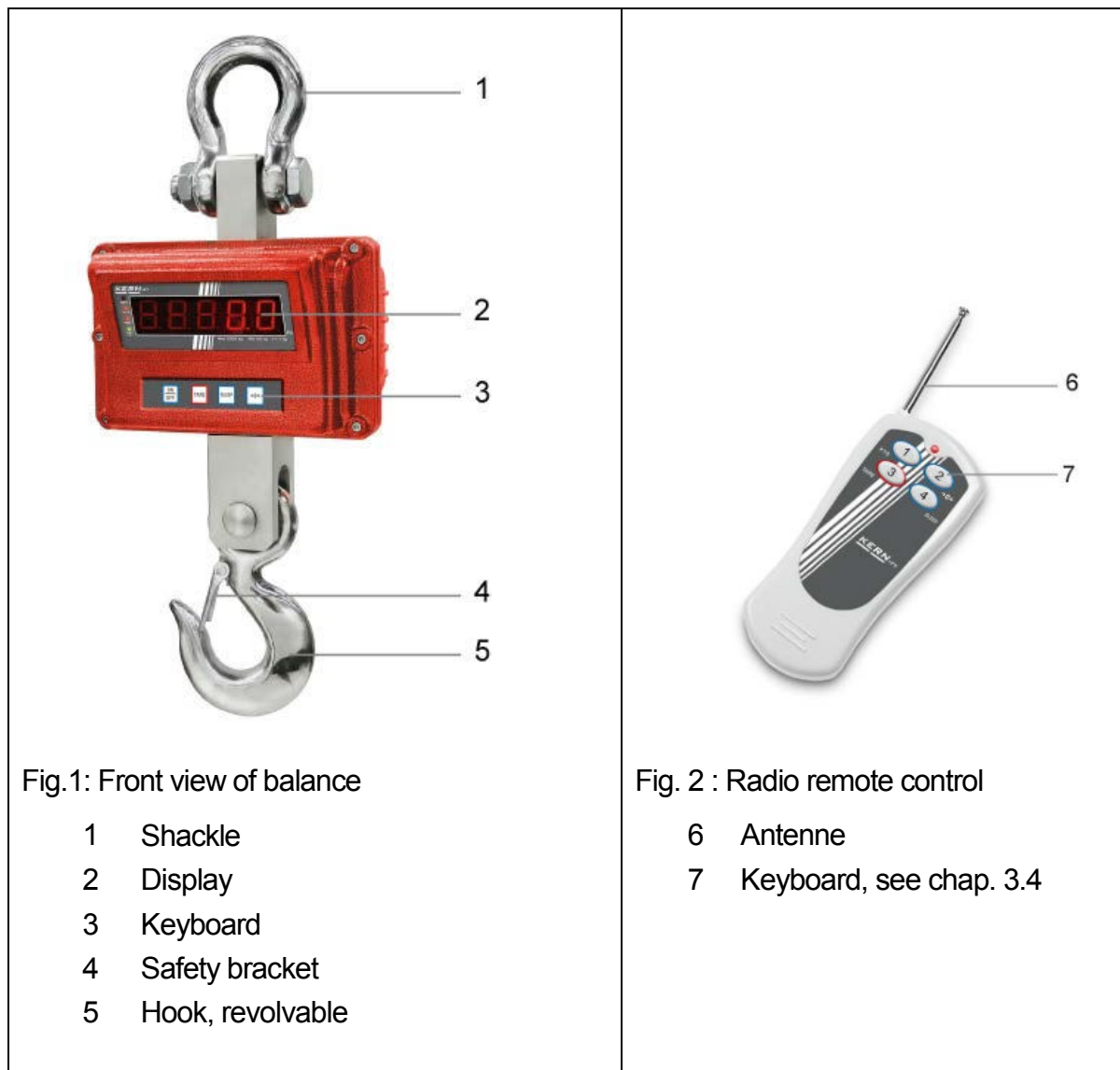

With the radio remote control, operation will be more comfortable yet.

3.1 Overview







3.2 Display



LED	The LED lights up, if
	the weight display is stable
	the weight is in the area around the zero point
	when the rechargeable battery is being recharged

3.3 Keyboard



Button	Description of function	In menu
	Turn on or off the balance	-
	Tare balance	<ul style="list-style-type: none"> ➤ Select menu items one by one ➤ For numeric entry increase numerical value
	Enable or disable sleep function	<ul style="list-style-type: none"> ➤ Exit menu item ➤ For numeric entry change decimal place
	Zeroing	<ul style="list-style-type: none"> ➤ Confirm entry ➤ For numeric entry change decimal place

3.4 Radio remote control

The balance can be operated by the radio remote control like by a keyboard. All functions (excepted **ON/OFF**) can be selected.

The red LED must light up when any button is pressed. If it does not light up, the batteries in the remote control must be exchanged.

Range on free surface (free of buildings) approx. 20 m.

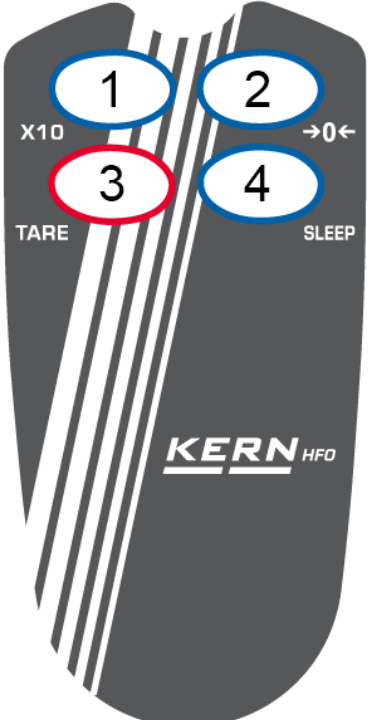
	1: x10	Show additional decimal place for short time
	2: →0←	Zeroing
	3: TARE	Taring
	4: SLEEP	For changing to standby/sleep mode see chap. 5.7

3.5 Label



- ⇒ Do not stand or go under suspended loads.
- ⇒ Do not use on building site.
- ⇒ Keep an eye on suspended loads.



(example)

- ⇒ Do not exceed the nominal load of crane, crane scales or any kind of load attachment devices at the crane scales.







- ⇒ The product conforms to the requirements of the German Equipment and Product Safety Act.

4. Commissioning



Always observe chapter 2 „General Safety Instructions“!

4.1 Unpacking

 <p>SAFETY INSTRUCTIONS for protection against break</p>	<p>Once delivered and unpacked, crane scales will not be taken back.</p>
	<p>The crane scales have been sealed by Messrs. KERN.</p> <ul style="list-style-type: none">⇒ Shackles and hooks are sealed by Sella tape.⇒ The packaging is also sealed by adhesive tape. <p> Broken seal obliges to purchase.</p> <div style="text-align: center;"><p>Fig.: Seal</p></div>
	<p>Thanks for your comprehension. Your KERN Quality assurance team</p>
 <p>Danger for the back!</p>	<p>The crane scales are compact and quite heavy.</p> <ul style="list-style-type: none">⇒ Remove the scales from packaging only with the help of a second person.⇒ Use a lifting device such as a crane or a forklift truck.⇒ Secure the scales that they cannot fall down when they are lifted.



Only use original packaging for returning.

- ⇒ Make sure that all parts are completely present.
 - Crane scales
 - Mains adapter
 - Remote control
 - Operating instructions (logbook)

4.2 Before first use check the dimensions and note them down on the checklist

- ⇒ Enter the dimensions in the checklist (see chapter 9.3) as per the drawings in chapter 9.5. For that purpose, use appropriate control measures.

4.3 Rechargeable battery operation

  	<p>ATTENTION</p> <ul style="list-style-type: none">⇒ The rechargeable battery and the charging unit match to each other. Only use the delivered mains adapter.⇒ Do not use the crane scales during the loading process.⇒ The rechargeable battery can only be replaced by the same or by a type which has been recommended by the manufacturer.⇒ The rechargeable battery is not protected against all environmental conditions. If the rechargeable battery is exposed to certain environmental influence, the rechargeable battery may set on fire or explode. Persons can be severely injured or material damage may occur.⇒ Protect the rechargeable battery against fire and heat.⇒ Do not bring the rechargeable battery in contact with liquids, chemicals or salts.⇒ Do not expose the rechargeable battery to pressure or microwaves.⇒ The rechargeable battery and the charger may not be modified or manipulated under any circumstances.⇒ Do not use a defective, damaged or deformed rechargeable battery⇒ Do not connect or short-circuit the electrical contacts of the rechargeable battery with metallic objects.⇒ From a damaged rechargeable battery may escape liquids. If the liquid comes into contact with skin or eyes, the skin and the eyes may be irritated.⇒ Ensure the correct polarity when inserting or exchanging the rechargeable battery (see instructions in the rechargeable battery compartment)⇒ The rechargeable battery operation is overridden when a mains adapter is being connected. If weighing more than 48 hours with mains operation, the rechargeable batteries have to be removed! (Danger of overheating).⇒ If the rechargeable battery starts to smell, being hot, changing the colour or being deformed, it must be immediately unplugged from mains supply and from the balance if possible.
---	--

Loading the rechargeable battery:

Before the first use, the rechargeable battery should be charged by connecting it to the mains power cable for at least 24 hours. The operating time of the rechargeable battery is approx. 50 hours.

When the capacity of the rechargeable battery is almost exhausted you will hear an audio signal; if the battery is not recharged the weighing scale will shut down after approx. 5 seconds so as to preserve battery life. Connect the weighing scale as quickly as possible via a cable to the power supply in order to recharge the battery.

The LED display above  informs you during loading about the loading status of the rechargeable battery.

red: Charging storage battery

green: Rechargeable battery completely reloaded

Remove the battery when the crane scale will not be in use for a longer period of time.

4.4 Standby mode (sleep mode)

The crane scales change into the standby mode (sleep mode) when any key is pressed or when for 5 minutes (factory setting) no weight change has been measured. Only one segment remains lighting. In order to finish the standby mode, press any key on the keyboard or on the remote control.

Switch-off time selectable after 0, 5, 10, 20, 30 minutes, see chap. 6.2 „F5 sl“.

4.5 Suspending the balance

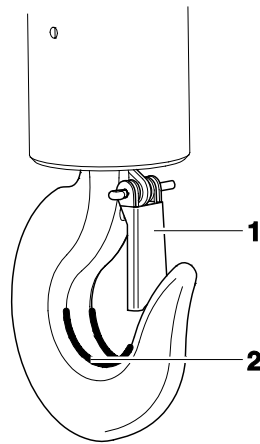

Condition

The crane needs a safety bracket (1) that the unloaded crane scales cannot fall down.

If the safety bracket is missing or damaged, please contact the crane manufacturer in order to receive a hook with this safety equipment.





 **The hook scales can be used solely with a crane equipped with a swivel joint**

⇒ Suspend the crane scales on the lower hook of a crane and close the safety bracket.

The crane scale's upper eyelet should rest in the saddle (2).

5. Operation

5.1 Safety instructions

	 <p>Risk of injury due to falling loads!</p> <p>Danger</p>
  <p>(example)</p>	<ul style="list-style-type: none"> ⇒ Take great care when operating the crane and follow the general rules for crane operation. ⇒ Check all parts (hook, eyelet, rings, rope slings, cables, chains etc.) for excessive wear or damage ⇒ If faults can be seen on the safety bracket of the hook or if it is missing completely, the scales must not be used ⇒ Work only with appropriate speed ⇒ Always avoid vibrations and horizontal forces. Avoid any kind of shock, torsion and oscillating (e.g. caused by inclined suspending) ⇒ Do not use the crane scales for transporting loads. ⇒ Do not stand or go under suspended loads. ⇒ Do not use on building site. ⇒ Keep an eye on suspended loads. ⇒ Do not exceed the nominal load of crane, crane scales or any kind of load attachment devices at the crane scales. ⇒ For weighing dangerous goods (e.g molten masses, radioactive materials) the “Dangerous Goods Regulations” are to be regarded!

5.2 Loading the crane scales

For good weighing results observe the following, illustrations see next page:

- ⇒ Only use load attachment devices which guarantee a one-spot suspension and where the scales can be suspended freely.
- ⇒ Do not use too large load attachment devices which do not guarantee any one-spot suspension.
- ⇒ Do not use multiple suspensions.
- ⇒ Do not pull or push the load or the loaded balance.
- ⇒ Do not pull the hook horizontally.

Loading the balance

1. Position the hook of the crane scales over the load.
2. Move downwards the crane scales until the load can be suspended on the hook of the balance. Reduce the speed when the respective height is going to be reached.
3. Suspend the load on the hook. Ensure that the safety bracket is closed. If the load is fixed by slings, ensure that the slings rest completely on the saddle of the balance hook.
4. Lift-off the load slowly.

When the load is fixed by slings, ensure that the load is well balanced on both sides and that the slings are correctly positioned



Attachment devices are not included in the delivery.

Standardised attachment devices are to be used to attach loads.

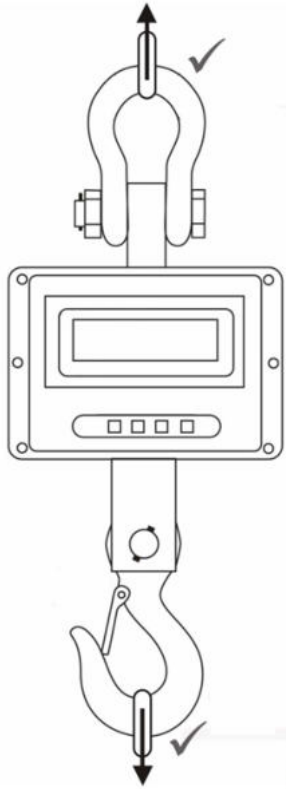

Only use load attachment devices which guarantee a one-point suspension and where the scales can be suspended freely.

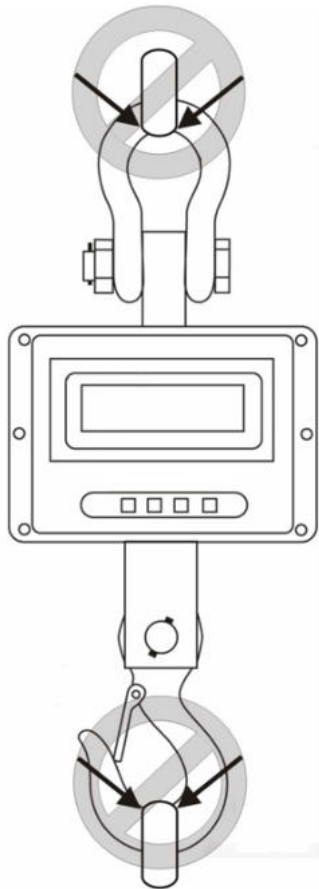

Do not use too large load attachment devices which cannot guarantee a one-point suspension.

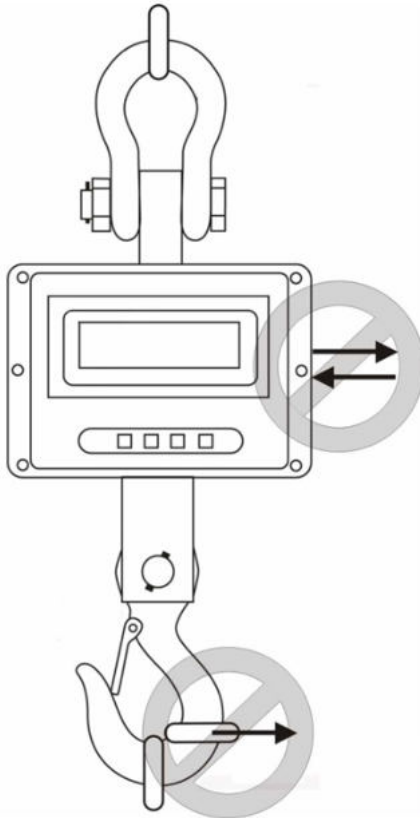

Do not push or pull

Do not pull the hook horizontally

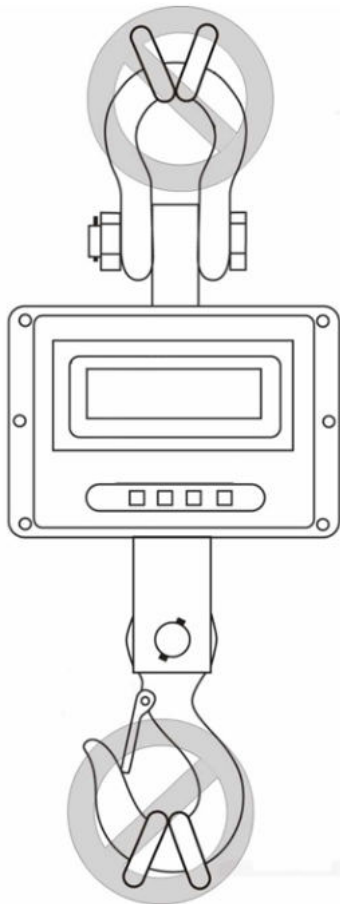

Do not use multiple suspensions

5.3 Turn on/off

Switch on

- ⇒ Press  on the keyboard of the balance. The display lights up and the balance carries out a selftest. The selftest is completed when the weight value 0 appears on the display.



Switch on only possible at the keyboard of the balance.

Switch off

- ⇒ Press  on the keyboard of the balance.

5.4 Balance zeroing

In order to obtain optimal weighing results, reset to zero the balance before weighing.

Manual

- ⇒ Unload the balance

- ⇒ Press .
- In the display appears 0 (kg) and the **LED →0←** lights up.

5.5 Taring

⇒ Attach preload.



Press . In the display appears 0 (kg) and the LED →0← lights up. The weight of the container is now internally saved.

⇒ Weigh the material, the net weight will be indicated.

⇒ After removing the preload weight appears as negative display.

⇒ To delete the tare value, remove load from crane balance and press .



5.6 Weighing

⇒ Loading the crane scales.

The weight value will be displayed at once. After standstill control the LED  lights up.



Overload warning

Overloading exceeding the stated maximum load (max) of the balance, minus a possibly existing tare load, must be strictly avoided. This could cause damage to the balance.

Exceeding the maximum load is indicated by the display „--ol-“. Unload balance or reduce preload.

5.7 Sleep function (standby function)

This function can be set in the menu under menu item F6 sL.

If the load is less than the minimum weight specified for the weighing scale, the weighing scale will change to sleep mode after a previously set time.

- Now the display will only show one decimal place.









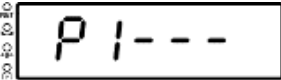

Exiting sleep function:

- As soon as a load is attached or
- by pressing any key,





the weighing scale will change to weighing mode.

6. Menu

6.1 Navigation in the menu

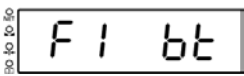
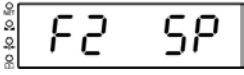
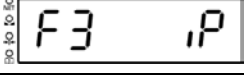
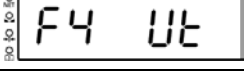
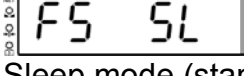
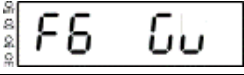
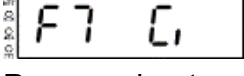
<p>Call function</p>	<p>⇒ Switch off the balance. With the weighing scale turned off press  and  at the same time.</p> <p>To that end press  briefly.</p> <p>⇒ You will hear an audio signal, release the keys,</p> <p> is displayed</p> <p>⇒ Enter password:</p> <p>Either</p> <p>Standard password "000" - </p> <p>Press  to select decimal place, press  to increase digit</p> <p>or</p> <p>personal password, see function F8 ci</p> <p>⇒ Confirm with ZERO button. The first function „F0 di“ is displayed.</p>
<p>Select function</p>	<p>⇒ With help of , the individual functions can be selected one after the other.</p>
<p>Select setting</p>	<p>⇒ Confirm selected function by . The current setting will be displayed.</p>
<p>Change settings</p>	<p>⇒ Switch into the available settings using .</p>
<p>Confirm setting</p>	<p>⇒ Press , balance returns to menu</p>
<p>Exit menu / Return to weighing mode</p>	<p>⇒ Press .</p>

6.2 Overview:

Function	Available settings	Description
	Not documented	
	Not documented	
	Internal A/D converter value	
	Not documented	
 Sleep mode (standby) see chap. 5.7	SLP 0 SLP 1* SLP 2 SLP 3 SLP 4	Sleep mode turned off Sleep mode after 5 min Sleep mode after 10 min Sleep mode after 20 min Sleep mode after 30 min
	Not documented	
 Password entry	In „P1- - -“ display increase the flashing number using  , select number using  . Confirm input by  .	
	Adjustment, see chap. 7	

* = default setting







7. Adjustment





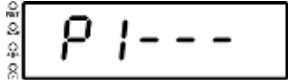



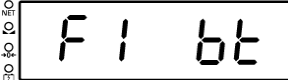

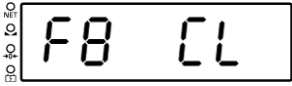

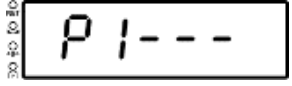

As the acceleration value due to gravity is not the same at every location on earth, each balance must be coordinated - in compliance with the underlying physical weighing principle - to the existing acceleration due to gravity at its place of location (only if the balance has not already been adjusted to the location in the factory). This adjustment process must be carried out for the first commissioning, after each change of location as well as in case of fluctuating environment temperature. To receive accurate measuring values it is also recommended to adjust the balance periodically in weighing operation.

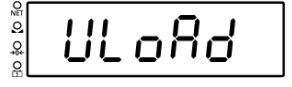

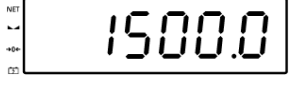
- The adjustment weight to be used depends on the capacity of the scale. Carry out adjustment as near as possible to the scale's maximum weight. Info about test weights can be found on the Internet at: <http://www.kern-sohn.com>.
- Observe stable environmental conditions. A warming up time (see chapter 1) is required for stabilization.

7.1 Adjustment

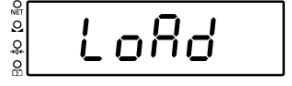
<p>⇒ Switch-off balance and attach a carrying help if necessary</p>	
<p>⇒ With the weighing scale turned off, press  and  at the same time. To that end press  briefly. ⇒ You will hear an audio signal, release the keys, P1 --- is displayed.</p>	
<p>⇒ Enter password: Either standard password 000 Press  to select decimal place, press  to set numerical value. or personal password, see menu under menu item F7 Ci</p>	 (Example standard password 000)
<p>⇒ Confirm password with , the first menu item "F1 bt" will be displayed</p>	

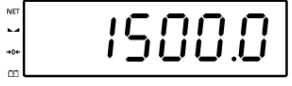
<p>⇒ Press  repeatedly until F8 CL appears on the screen</p>	
<p>Press adjustment switch (Position adjustment switch see chap.7.3)</p>	
<p>⇒ Press , P1--- will reappear</p>	
<p>⇒ Press the buttons  and  to re-enter the password 000 as described above</p>	
<p>⇒ Confirm with , Uload appears</p>	
<p>⇒ Remove load from scale and wait until the LED  lights up, then</p> <p>⇒ Press , again, the current set adjustment weight is displayed.</p>	 <p>(example)</p>
<p>⇒ Either</p> <p>use indicated adjustment weight and confirm by </p> <p>or</p> <p>enter new adjustment weight:</p> <p>Press  to select digit, press  to increase flashing digit and press  to confirm, Load will be displayed</p>	
<p>⇒ Attach the adjustment weight and wait until the LED  lights up.</p>	
<p>⇒ Press , PASS will briefly be shown</p>	

After successful adjustment the balance carries out a selftest, then it automatically returns to weighing mode.

An adjustment error or incorrect adjustment weight will be indicated by the error message; repeat adjustment procedure.

7.2 Verification

General features:

According to EU directive 2009/23/EC balances must be officially verified if they are used as follows (legally controlled area):

- a) For commercial transactions if the price of goods is determined by weighing.
- b) For the production of medicines in pharmacies as well as for analyses in the medical and pharmaceutical laboratory.
- c) For official purposes
- d) For manufacturing final packages

In cases of doubt, please contact your local trade in standard.

Verification notes:

An EU type approval exists for balances described in their technical data as verifiable. If a balance is used where obligation to verify exists as described above, it must be verified and re-verified at regular intervals.

Re-verification of a balance is carried out according to the respective national regulations. The validity for verification of balances in Germany is e.g. 2 years.

The legal regulation of the country where the balance is used must be observed!



Verification of the balance is invalid without the seal.

The seal marks attached on balances with type approval point out that the balance may only be opened and serviced by trained and authorised specialist staff. If the seal mark is destroyed, verification loses its validity. Please observe all national laws and legal regulations. In Germany a re-verification will be necessary.

7.3 Position of adjustment switch

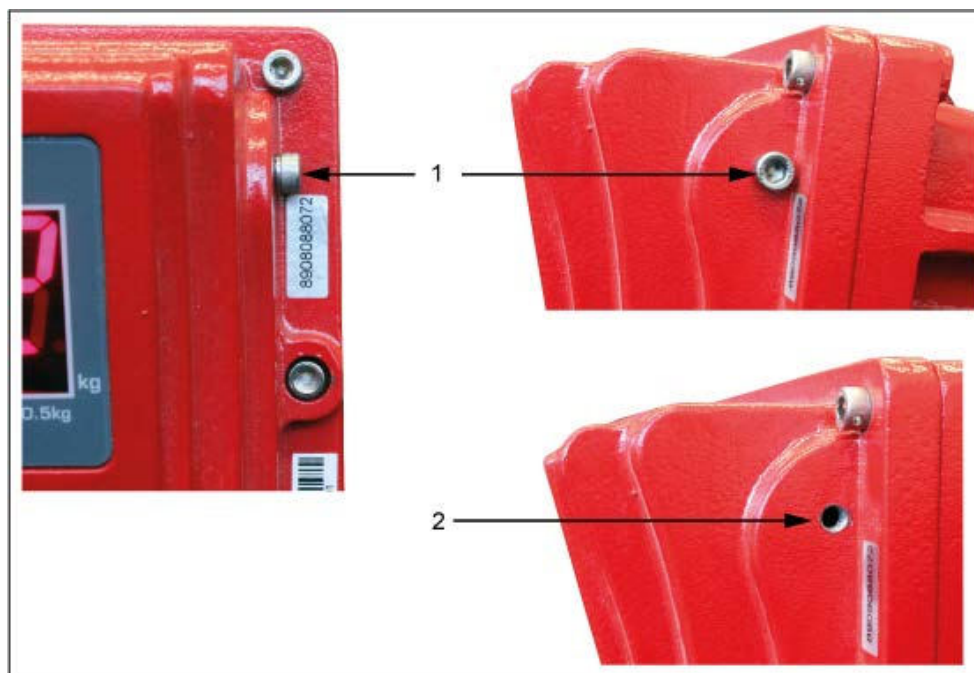

Detach sealing screw (1), the adjustment switch is situated inside the housing (2)

8. Error messages

Error message	Description	Possible causes / Remedy error
--ol-	Maximum load exceeded	⇒ Reduce load ⇒ Check whether the balance has been damaged
Err 4	Zero setting range exceeded during start-up	⇒ Turn off weighing scale, remove load
Err 5	Keyboard error	⇒ Improper operation of the balance
Err 6	Value outside the A/D changer range	⇒ Damaged weighing cell ⇒ Damaged electronics
Fail h	Error during adjustment	⇒ Repeat adjustment.
Err 19	Zero point drift	⇒ Remove additional preloads (vessels) from load receptor. ⇒ Adjustment of weighing scale

Should other error messages occur, switch balance off and then on again. If the error message remains inform manufacturer.

9. Cleaning, Repair, Maintenance and Disposal

	Prior to any maintenance, cleaning and repair work disconnect the device from the operating voltage.
---	--

 Danger	Risk of injury and risk of material damage! The crane scales are part of a hoisting device! For safe operation please pay attention to the following: <ul style="list-style-type: none">⇒ Have carried out a regular maintenance by trained specialized staff⇒ Carry out regular maintenance and care, see chapter 9.2.⇒ Have the parts exchanged only by trained specialized staff.⇒ If there arose discrepancies with the safety checklist, the balance must not more be put into operation.⇒ Do not repair the crane scales by yourself. The repairs can be carried out solely by the company OH&S specialist.
--	--

9.1 Cleaning and Disposal

 CAUTION	Damage on the crane balance! <ul style="list-style-type: none">⇒ Do not use any industrial solutions or chemicals
---	--

- ⇒ Clean the keyboard and the display with a soft cloth soaked in mild window cleaning agent.
- ⇒ Disposal of packaging and appliance must be carried out by operator according to valid national or regional law of the location where the appliance is used.

9.2 Regular maintenance and care

- ▲ Regular inspections and maintenance works should be carried out at intervals stipulated in chapter 9.6.
- ▲ The regular 3-month maintenance may only be carried out by an expert with competent knowledge of working with crane scales. Thereby the national regulations for prevention of accidents as well as the working, operation and safety regulations of the owner-operator.
- ▲ Always use validated control measures/feeler gauges for checking.
- ▲ Regular technical inspections (every 12 months) can be carried out solely by the trained personnel (company OH&S specialist).
- ▲ The results of the maintenance must be written down in the checklist (chap. 9.3).
- ▲ The additional results of the extended maintenance have to be entered in the checklist (chapter 10.1).
- ▲ The replaced spare parts also must be entered, (chapter 10.2)

Regular maintenance:

<p>Initial start-up, every 3 months</p>	<ul style="list-style-type: none"> ▪ Enter and verify all dimensions, see the “Checklist”, chap. 9.3 ▪ Check the shackle or the eyelet for wear and tear, such as e.g. plastic deformation, mechanical damage (unevenness), notches, striation, cracks, corrosion, thread damage and torsions. ▪ Visual inspection and checking the function of the articulated joint ▪ Check the application of the safety bracket on the hook, moreover check for fault and correct function ▪ For balances of big construction size: Check that the split pin and the nut on the shackle are not loose <p>If a dimension exceeds the admitted deviation from the original dimension (see checklist, chap. 9.3) or if other discrepancies have been found, the balance must be repaired at once by trained specialized staff ((company OH&S specialist). Never do repair it by yourself! Take balance out of operation immediately!</p> <p>All repairs and spare parts must be documented by the service partner (see list, chap.10.2).</p>
<p>Every 12 months</p>	<ul style="list-style-type: none"> ▪ All load-transferring parts must be verified and documented by personnel qualified for extended maintenance (see the “Checklist”, chap.10.1).

Hint

During the revision watch out for wear and tear according to the following drawings (see chap.9.5)

9.3 Checklist „regular maintenance“



Additional information on the maintenance works can be found in the table below (see chapter 9.4) and in figures in chapter 9.5

	Shackle					Hook									Date	Inspector
	a	b	c	Wear (see grey fields)	Cotter pin and nut	d	e	f	g	h	Angle α	Wear (see grey fields)	Detent	Articulated joint		
Max. acceptable deviation	5%	0%	5%	No deformations or cracks	Well fixed	10 %	5%	5%	5%	± 1 mm	10°	No deformation s or cracks	Correct operation	Check function		
Dimensions before first use																
3 months																
6 months																
9 months																
12 months																

bold letters = Those technical inspections must be carried out by the company OH&S specialist.

9.4 Maintenance table

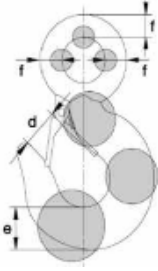
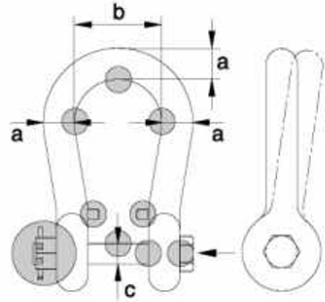
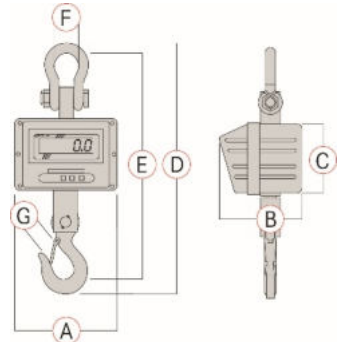
Part	Drawing	Component	Inspection	Limits
Hook		Detent	Inspection concerning operation and damage	No damage is acceptable, operation must be ensured.
		Articulated joint	Check function	Correct operation
		Eye and hook	Inspection concerning dimensions and damage	As per Table 9.3
Shackle		Locking bolt	If it is not loose	It must not be loose.
		Shackle	Inspection concerning dimensions and damage	As per Table 9.3
		Cotter pin + nut	Inspection concerning damage and positioning	Correct positioning as per Table 9.3
Crane scale		Screw connections	Loose	It must not be loose.
		Crevice between the hook and the enclosure	Dimension check	As per Table 9.3

9.5 Drawings of a hook, shackle and crane scale

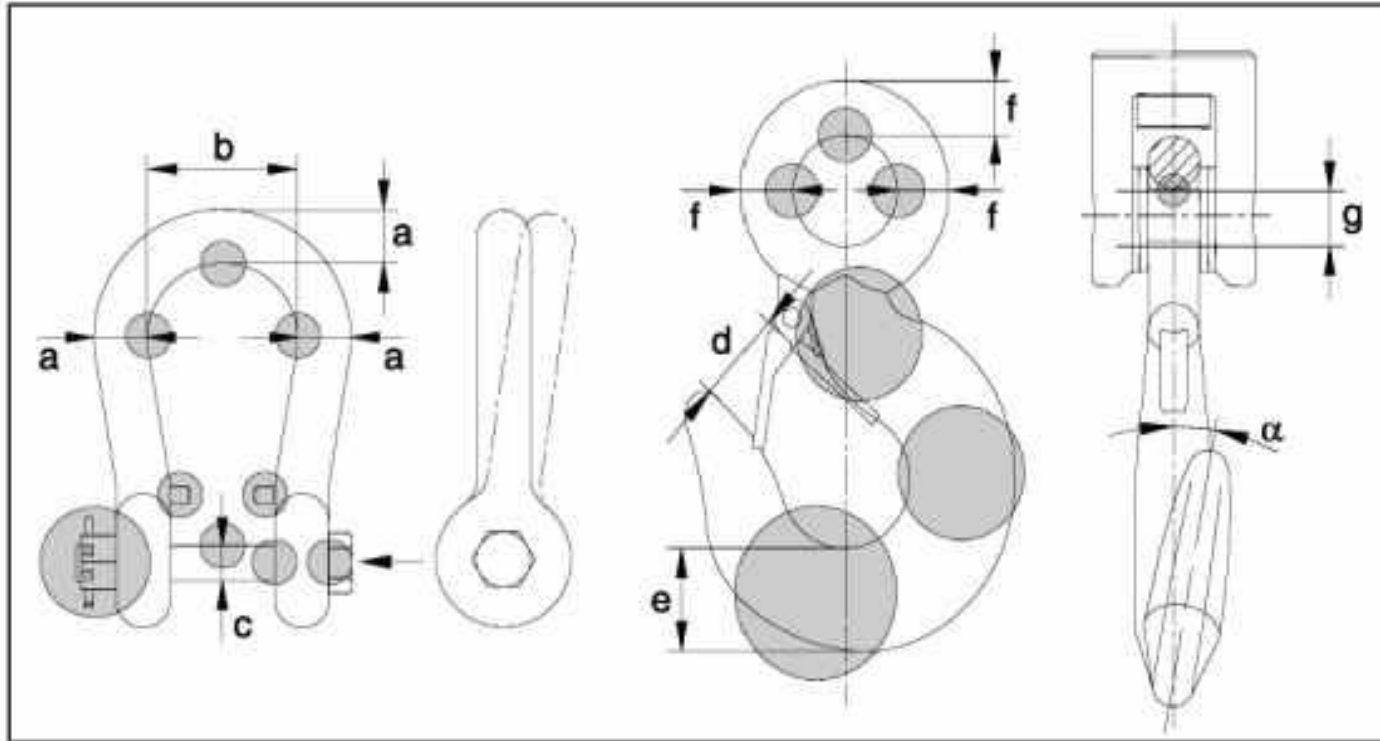

9.6 Inspection cycles

Inspection	Every day	Every 7 days	Every 3 months	Every 12 months
Presence of all crane scale parts	<input checked="" type="checkbox"/>			
Visual inspection for damage	<input checked="" type="checkbox"/>			
Visual inspection and operation inspection of the hook detent	<input checked="" type="checkbox"/>			
Visual inspection and checking the function of the articulated joint	<input checked="" type="checkbox"/>			
Inspection of the shackle cotter pin and nut	<input checked="" type="checkbox"/>			
Impurities		<input checked="" type="checkbox"/>		
Marking inspection (legible nameplate)		<input checked="" type="checkbox"/>		
Inspection of all dimensions as per the checklist 9.3			<input checked="" type="checkbox"/>	
Extended maintenance by the company OH&S specialist, see chapter 10.1				<input checked="" type="checkbox"/>

9.7 Drawing with “h” dimension

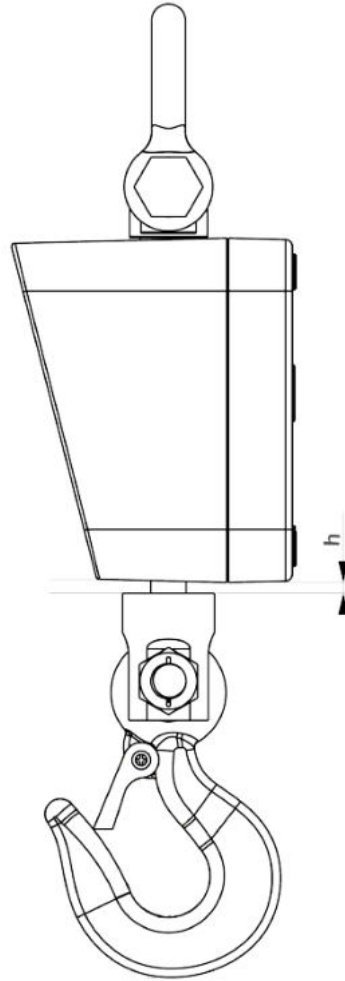

10. Enclosure

10.1 Checklist „Enhanced maintenance“ (General revision)

The enhanced maintenance has to be carried out by the company OH&S specialist.

Crane scales		Model Serial no.				
Interval	Hooks	Shackle	Screwed connections	Date	Name	Signature
12 months						

10.2 List „spare parts and repair of safety-relevant parts“

Repair has to be carried out by the company OH&S specialist.

Crane scales		Model Serial no.		
Part	Action	Date	Name	Signature

11. Instant help

Possible causes of errors:

In case of an error in the program process, briefly turn off the balance and disconnect from power supply. The weighing process must then be restarted from the beginning.

Fault	Possible cause
The displayed weight does not glow.	<ul style="list-style-type: none">• The balance is not switched on.
The balance cannot be switched on	<ul style="list-style-type: none">• Load/replace the rechargeable battery• On/Off button defective• On/Off button not correctly actuated
The display does not react to load change	<ul style="list-style-type: none">• Load cell defective• Load cell cable defective
Loading display does not glow during loading	<ul style="list-style-type: none">• Power supply unit defective• Power supply unit not correctly connected
The displayed weight is permanently changing	<ul style="list-style-type: none">• Vibrations on the hook• Suspended load does not stand still• Load cell defective
The weighing result is obviously incorrect	<ul style="list-style-type: none">• The balance has not been reset to zero before weighing• The adjustment does not match with the installation place or has been misadjusted.• Wrong weighing unit selected
The desired weighing unit cannot be called by UNIT key.	<ul style="list-style-type: none">• Unit was not activated beforehand.
Error message „-ol-“	<ul style="list-style-type: none">• Maximum load of the balance exceeded
The menu settings cannot be changed.	<ul style="list-style-type: none">• The menu is locked Remove the menu lock.
The remote control does not work	<ul style="list-style-type: none">• Batteries empty, insert new batteries• Too much distance between balance and remote control• Obstacles block the reception