

Additel 761A Automated Pressure Calibrator

—————User Manual

[Version:1911V01]

Additel Corporation

STATEMENT

This user manual provides operating and safety instructions for the ADT761A Automated Pressure Calibrator. To ensure correct operation and safety, please follow the instructions in this manual. Additel Corporation reserves the right to change the contents and other information contained in this manual without notice.

CONTENT

Warnings	1
General safety	2
1. Introduction	3
1.1 Overview	3
1.2 Features.....	3
1.3 Environmental Conditions.....	4
1.4 Power	4
1.5 Specifications	4
2. Installation.....	10
2.1 Features.....	10
2.1.1 Basic structure.....	10
2.1.2 Electrical and signal port	12
2.1.3 Keypad.....	13
2.1.4 Pressure ports	14
2.2 Initial preparation.....	15
2.2.1 Battery installation	15
2.2.2 Changing the shoulder strap	16
2.2.3 Pressure connection.....	18
2.2.4 View the display.....	19
2.3 Getting started	19

2.3.1 Power on	19
2.3.2 Setting the system date and time	20
2.3.3 Generating a pressure	20
2.3.4 Display and operation	20
3. Display and Operation	20
3.1 Home screen	20
3.1.1 Status bar	21
3.1.2 Module and split screen display area	23
3.1.3 Main interface keypad operation	23
3.2 Pressure control	24
3.2.1 Pressure output	24
3.2.2 Pressure measurement	27
3.2.3 Pressure unit	28
3.3 Electrical signal measurement	28
3.3.1 Current/Voltage measurement	29
3.3.2 Switch test	32
3.3.3 HART Communication	33
3.3.4 PROFIBUS PA communication	41
3.4 Electrical output	43
3.5 External pressure module	47
3.6 Typical applications	49
3.6.1 Pressure gauge	49

3.6.2 Pressure transmitter.....	50
3.6.3 HART transmitter.....	53
3.6.4 Pressure switch	54
3.6.5 I/P converter	55
4.1 Control settings	57
4.2 Communication	59
4.2.1 Ethernet	59
4.2.2 Wireless communication.....	60
4.2.3 Bluetooth	61
4.3 Power management.....	62
4.3.1 Display brightness	62
4.3.2 Battery information.....	62
4.3.3 Energy settings	62
4.4 System calibration	63
4.4.1 Calibration of electrical measurement.....	64
4.4.2 Auto tune	65
4.4.3 Calibration of the supply pressure module.....	66
4.4.4 Calibration of the barometric pressure module.....	66
4.4.5 Pressure calibration.....	68
4.5 Services	69
4.5.1 System upgrade.....	69
4.5.2 Maintenance	70

4.5.3 Factory reset.....	71
4.6 Personalization.....	71
4.6.1 Date and time.....	72
4.6.2 Language	72
4.6.3 Sound	72
4.7 Cloud service.....	74
4.8 Data management.....	74
4.9 Product information.....	74
4.9.1 Host information	76
4.9.2 Control board information	76
4.9.3 Electrical measurement board information	76
4.9.4 Electrical source board information.....	76
4.9.5 Wireless module information	77
4.9.6 PROFIBUS module information	77
4.9.7 HART handheld communicator information	77
5. Documentation	77
5.1 Quick test	77
5.1.1 Pressure gauge	77
5.1.2 Pressure transmitter.....	79
5.1.3 Pressure switch	80
5.1.4 Pressure sensor	81
5.1.5 I/P converter	81

5.1.6 Signal isolator	82
5.2 Task.....	82
5.2.1 Analog pressure gauge	82
5.2.2 Digital pressure gauge	89
5.2.3 Calibrate a pressure transmitter	90
5.2.4 Pressure transducer	93
5.2.4 Pressure switch	95
5.2.6 I/P converter	98
5.2.7 Signal isolator	100
5.2.8 Contact pressure gauge.....	102
5.2.9 Valve opening gauge	106
5.3.2 Mercury barometer.....	110
5.3.3 Aneroid barometer.....	111
5.3.4 Barometric altimeter	112
5.3.5 Pressure transmitter.....	113
5.3.6 Pressure switch	113
5.4 Task (for barometric (BP) version).....	114
5.4.1 Digital barometer	114
5.4.2 Calibration of the mercury barometer	116
5.4.3 Aneroid barometer.....	119
5.4.4 Barometric altimeter	121
5.4.5 Pressure transmitter.....	122

5.4.6 Pressure switch	122
6. Application	123
6.1 Unit conversion	123
6.2 Pressure leak test	123
7. HART Communication	126
7.1 HART connection and search	126
7.2 HART communicator operation.....	126
8. System maintenance	128
8.1 Device information view	128
8.2 Diagnostic information.....	128
8.3 Check the sealing performance of the calibrator	128
8.5 Replacement of the filter at the air pressure output interface and the O-ring.....	130
8.6 Air filter replacement.....	132

Table Content

1. Introduction	
Table 1- 1 Specifications.....	5
Table 1- 2 Electrical measurement specification.....	7
Table 1- 3 General Index	9
1. Installation	
Table 2- 1 Electrical and signal port.....	13
Table 2- 2 Keypad function.....	14
2. Display and operation	
Table3- 1 Setting interface.....	27
Table3- 2 Scaling parameters.....	31
Table3- 3 Filtering parameters.....	32
Table3- 4 Hart Parameters	38
Table3- 5 Automatic step parameters	46
Table3- 6 Slope output parameters.....	47
3. Control setting	
Table 4- 1 Network connection	59
Table 4- 2 Static mode selection	60
Table 4- 3 Wireless network selection	60
Table 4- 4 Setup of wireless communication	61

Table 4- 5 Bluetooth setup	62
Table 4- 6 Date and time	72
Table 4- 7 Sound setup.....	73
Table 4- 8 Setup of cloud service	74
4. Documentation test	
Table 5- 1 Task analog pressure gauge information	84
Table 5- 2 Task setting of analog pressure gauge	86
Table 5- 3 Task save	88
Table 5- 4 Task pressure transmitter information	92
Table 5- 5 Task pressure sensor information	95
Table 5- 6 Task pressure switch information	97
Table 5- 7 Task I/P converter information	99
Table 5- 8 Task signal isolator information	101
Table 5- 9 Task contact pressure gauge information	104
Table 5- 10 Task setting of contact pressure gauge	105
Table 5- 11 Task valve opening gauge information	108
Table 5- 12 Task digital barometer	116
Table 5- 13 Task mercury barometer.....	118
Table 5- 14 Task barometric altimeter.....	122

Figure Content

2. Installation

Figure 2- 1 Basic structure	10
Figure 2- 2 Electrical and signal port.....	12
Figure 2- 3 Battery installation.....	16
Figure 2- 4 Changing the shoulder strap.....	17
Figure 2- 5 Gauge pressure connection.....	18
Figure 2- 6 Low pressure and differential pressure connection.....	19

3. Display and operation

Figure 3- 1 home screen	21
Figure 3- 2 Differential pressure outlet.....	24
Figure 3- 3 Gauge pressure outlet.....	25
Figure 3- 4 Pressure Measurement.....	28
Figure 3- 5 Current measurement.....	30
Figure 3- 6 Voltage measurement	30
Figure 3- 7 Switch test connection	33
Figure 3- 8 HART communication	34
Figure 3- 9 HART communication	35

4. Control setting

Figure 4- 1 Calibrate an atmospheric pressure module	67
--	----

5. Documentation test

Figure 5- 1 Calibration of digital pressure.....	89
Figure 5- 2 Calibration of the pressure sensor.....	93
Figure 5- 3 Calibration of the signal isolator	100
Figure 5- 4 Calibration of the contact pressure gauge.....	102
Figure 5- 5 Calibration of the valve opening gauge	106
Figure 5- 6 Calibration of the general digital barometer.....	114
Figure 5- 7 Calibration of the digital barometer	115
Figure 5- 8 Calibration of the mercury barometer	117
Figure 5- 9 Calibration of the aneroid barometer	120
Figure 5- 10 Calibration of the barometric altimeter.....	120
8. System maintenance	
Figure 8- 1 Disassembly of the suction filter.....	129
Figure 8- 2 Disassembly of air pressure/high-precision/barometric (BP) version pressure connector	130
Figure 8- 3 Disassembly of differential pressure/micro-differential pressure connector	131
Figure 8- 4 Disassembly and assembly of the air filter.....	132

Warnings

- ◆ Do not combine with another pressure source where pressure is being generated by both sources at the same time.
- ◆ Do not apply pressures greater than the maximum working pressure.
- ◆ Not for use in flammable, high humidity, or dusty environments.
- ◆ Do not expose the battery of unit to fire.
- ◆ Charge the battery only using the Additel adapter. Please follow proper recycling procedures when discarding the battery.

General safety

- ◆ Do not shake, drop or bump the calibrator while in use.
- ◆ If condensation has occurred, thoroughly dry out the 761A before startup.
- ◆ Connecting the REF port to the reference port of unit under test (UUT) with a small differential pressure range might result in control problems over time as the environmental temperature changes. Recommend low pressure port of UUT connect REF port to resolve control issues.
- ◆ The vent port should not face the operator during venting.
- ◆ Do not apply more than 30V between any two electrical jacks (except for voltage measurement jacks)
- ◆ Do not use any adapter other than Additel power adapter designed for the ADT761A. Charge the battery as soon as the battery symbol indicates.
- ◆ If the calibrator is not working properly, turn it off, remove the battery and contact Additel.
- ◆ Do not remove the battery while it is charging or when the calibrator is in use.
- ◆ Before turning off the calibrator, make sure the system pressure is reduced to the atmosphere pressure.

1. Introduction

1.1 Overview

The ADT761A Automated Pressure Calibrator is completely self-contained and automated with a built-in pump for pressure generation and precision control technology. ADT761A has many improvements over the previous calibrator:

Increased pressure range to 1,000 psi (70 bar), removable internal pressure modules, optional precision modules, touch screen display, Wi-Fi, Bluetooth, and Ethernet communications, double the original battery life, and more!

1.2 Features

- ◆ Automated and self-contained pressure generation and control to 1,000 psi (70 bar)
- ◆ Standard accuracy to 0.02%FS
- ◆ Optional precision accuracy models to 0.01%FS
- ◆ Two removable internal pressure modules for multi-range selection
- ◆ Control stability to 0.003%FS
- ◆ Portable, designed for use in the field and in the lab
- ◆ Ability to measure two external pressure modules
- ◆ Wi-Fi, Bluetooth, USB and Ethernet communication
- ◆ HART and profibus communication

- ◆ Data logging and task management
- ◆ Patented electric pump technology and improved speed

1.3 Environmental Conditions

- ◆ Using temperature: (0-50) °C
- ◆ Storage temperature: (-20-70) °C
- ◆ Environment humidity:<90%RH, Non-condensation
- ◆ Barometric pressure: (86~106) KPa

1.4 Power

- ◆ Working time: 12 hours
- ◆ Charging mode: charging with the unit or independently
- ◆ Charging time: less than 5 hours

1.5 Specifications

	761A-LLP	761A-D	761A-500	761A-1K	761A-APXR	761A-BP
Max Pressure Range	30 inH ₂ O (75)	35 psi (2.5 bar)	500 psig (35 bar.g)	1,000 psig (70)	Dependent on	1,200 hPa
Min Pressure Range	-30 inH ₂ O (-75)	-13.5 psi (-0.95 bar)	-13 psi (-0.9 bar)	-13 psi (-0.9 bar)	Dependent on	100 hPa
Accuracy(1)	0.05%FS	0.02%FS	0.02%FS ⁽²⁾	0.02%FS ⁽²⁾	0.01%FS	0.01%FS

Stability	0.005%FS or 0.05 Pa	0.005%FS	0.005%FS	0.005%FS	0.003%FS	0.02 hPa
Pressure Type	Differential, Gauge	Differential, Gauge	Gauge, Absolute	Gauge, Absolute	Gauge, Absolute	Absolute
Over Range Indication	120%					
Resolution	6 digits					
Measurement Units	Pa, hPa, kPa, mPa, bar, mbar, psi, mmHg@0°C, cmHg@0°C, mHg@0°C, inHg@0°C, inH2O@4°C, mmH2O@4°C, cmH2O@4°C, mH2O@4°C, mmH2O@20°C, cmH2O@20°C, mH2O@20°C, inH2O@20°C, kg/m2, mtorr, torr, lb/ft2, tsi, custom					
Barometric Accuracy	N/A	N/A	±60 Pa	±60 Pa	±60 Pa	N/A

Table 1- 1 Specification

[1] One year accuracy (including 1 year stability). FS specification applies to the span of the module range.

[2] Specification based on gauge measurement. An additional 60 pa uncertainty will need to be included when measuring in absolute mode. Applicable only for use with the ADT761A-500 and ADT761A-1K

- ◆ Stability: 0.005%FS or 0.05 Pa, whichever is greater. 761A-BP: 0.02 hPa
- ◆ Control response time: 20%FS pressure step, external 50cc volume access, high speed mode, <30 seconds;
- ◆ Media: Air

◆ Electrical measurement specification (environment temperature $20^{\circ}\text{C} \pm 5^{\circ}\text{C}$, one-year stability)

Model	Range	Resolution	Accuracy	Note
mA Measure	Auto-ranging ± 25 or ± 50 mA	0.1 μA	0.008%RD+0.004%FS	Impedance <10 Ω
V Measure	± 300 mV	1 μV	0.008%RD+0.002%FS	Impedance >1G Ω
	Auto-ranging ± 5 , ± 12 or ± 30 V	$\pm 5\text{V}$:20 μV $\pm 12\text{V}$:100 μV	0.008%RD+0.002%FS	Impedance >1M Ω
Loop Power Source	24 V	N/A	± 0.24 V	50 mA (Max Loading)
mA Source	0 to 2.5 mA or 2.5 to 25 mA	0-2.5 mA: 0.05 μA 0-25 mA:0.5 μA	0-2.5 mA: 0.008%RD+0.1 μA 0-25 mA: 0.008%RD+1.0 μA	20 mA @ 1K Ω
Power Source	16 to 30 V	1 V	± 0.5 V(24 V: ± 0.24 V)	70 mA (Max Loading)
V Source	0 to 16 V	250 μV	0.008%RD+0.002%FS	
Pressure Switch	Mechanical Switch, Live Mechanical Switch, NPN Switch, PNP Switch	N/A	N/A	Response time<10 ms. If the switch is live, voltage range will be (3-30) V

Temperature Compensation	5°C to 35°C
Temperature Coefficient	Outside of 5°C to 35°C: $\pm 0.0005\%RD + 0.0001\%FS/^\circ C$
Misuse Protection	Up to 30 V on any two sockets

Table 1- 2 Electrical measurement specification

◆ General Specifications

Specification	Description
User Interface	Color touch screen and/or keypad operation
Channels	Four total: one electrical, high or low internal pressure module, two external pressure modules
Enclosure IP Rating	IP31
Battery	Rechargeable Li-Ion battery, typically 16 hours of operation, recharges in less than 5 hours.
Power	Rechargeable Li-Ion battery, external power 110/220, power adapter 27 V
Display	7" TFT touch screen 800 x 480 color
Communications	USB, LAN, Bluetooth, Wi-Fi
Weight	<17.52 lb (7.95 KG)
Size	11.77 x 7.60 x 7.56 in (299 x 193 x 192 mm)

Certification	ISO17025 accredited certificate of calibration with NIST-traceable data	
Data Storage	6 GB	
Data Logging	Up to 1,000,000 readings (data and time stamped)	
Task documentation	Up to 1000 tasks can be stored with data	
Automation Functions	Switch test, auto step, leak test	
User Interface Localization	English, German, French, Italian, Spanish, Portuguese, Chinese, Japanese, and Russian	
Pump life	>1,000,000 cycles	
Environmental Specifications	Operating temperature: 32°F to 122°F (0°C to 50°C)	
	Compensated temperature: 32°F to 122°F (0°C to 50°C)	
	Storage temperature: -20°C to 60°C (-4°F to 120°F)	
	Humidity: <90%, non-condensing	
Vibration and Shock	Vibration: 4g (20 to 2,000 Hz)	Shock: 8g, 1 meter drop test
Compliance	CE	
Software Compatibility	ACal, Additel Land and Additel Link for access via mobile application	

Warranty	1 year
----------	--------

Table 1- 3 General Index

- ◆ Optional Software
 - ACal and Additel Land
 - Additel Link for access via mobile application

2. Installation

2.1 Features

2.1.1 Basic structure

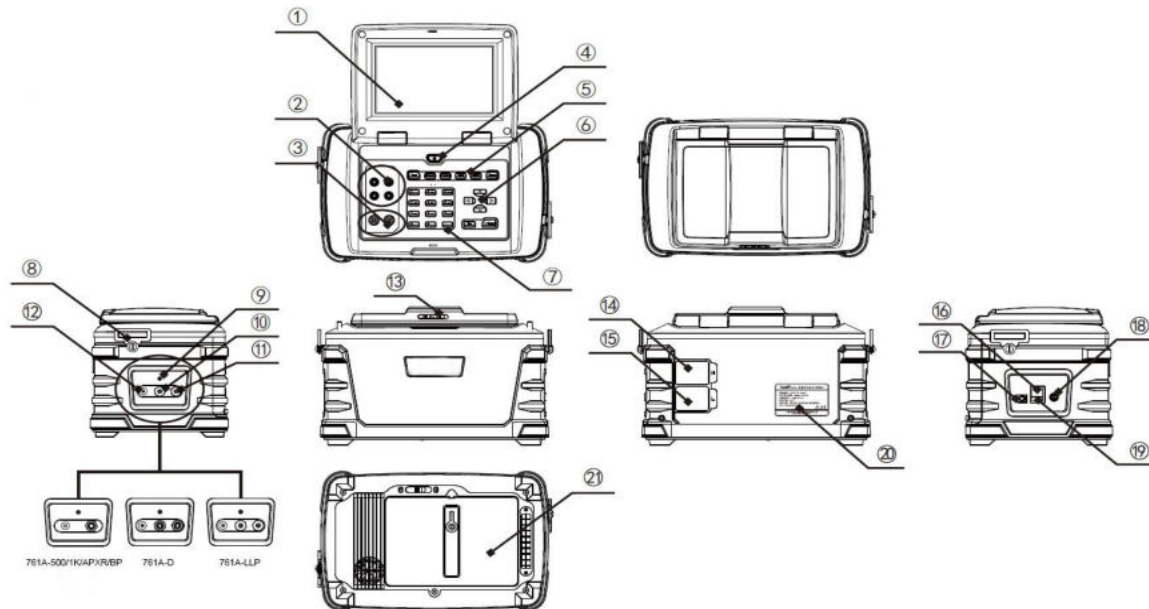

Figure 2- 1 Basic structure

Item	Name
①	Screen
②	PC Board
③	Connector Interface
④	On/Off
⑤	Shortcut keys
⑥	Function keys
⑦	Numeric Keypad
⑧	Strap connections
⑨	Atmosphere port
⑩	REF/FLT Port
⑪	Output Port
⑫	Vent Port
⑬	Lock
⑭	High Pressure Module
⑮	Low Pressure Module
⑯	LAN Interface
⑰⑱	USB port
⑲	Power supply input
⑳	Label

②①	Battery
----	---------

2.1.2 Electrical and signal port

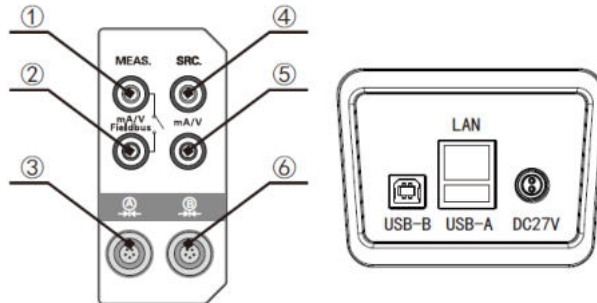







Figure 2- 2 Electrical and signal port

Port	Description
①②	Current, Voltage, Switch measurement and HART, Profibus PA bus communication, Red is positive , Black is negative
④⑤	Current, Voltage and power output, Red is positive , Black is negative
③	Jack A for connecting external pressure module

⑥	Jack B for connecting external pressure module
DC27V	Power adapter connection port
LAN	Ethernet interface
USB-A	Flash drive connection
USB-B	Computer connection

Table 2- 1 Electrical and signal port

2.1.3 Keypad

Item	Keypad	Description
1		On/Off Key: Power
2		Shortcut Key: Pressure vent
3		Shortcut Key: Pressure measure
4		Shortcut Key: Control pressure
5		Shortcut Key: Snapshot
6		Shortcut Key: Setup interface





7		Shortcut Key: Return home
8		Shortcut Key: Cancellation or Return function
9		Shortcut Key: Fulfillment or confirmation function
10		Navigate key: Up, down, left, right key
11	Numeric Key	

Table 2- 2 Keypad function

2.1.4 Pressure ports

- ◆ Output port (OUTLEF): Pressure output port, connecting UUT. If the control volume larger than (0~100) cc, the pressure stability will be affected.
- ◆ Reference port (REF): If calibrator measure and calibrate the gauge pressure instruments, please keep the REF port open. If calibrator measure and calibrator the differential pressure instruments, REF port should be connected with reference port of UUT for isolating airflow fluctuation to obtain stable pressure control.
- ◆ Venting port (VENT): Venting port is used for pressure relief quickly and drain contamination. During use process, if mist is venting out, it is recommended to collect the moisture avoiding contamination in the connected hose

-
- ◆ Barometric pressure calibration port (ATM): Used for calibrating the internal barometric pressure sensor. Connect to this port by $\varnothing 4$ gas hose. See 4.4.4 barometric module standard in the specific operation.

2.2 Initial preparation

2.2.1 Battery installation

As shown in Figure 2-3, Open upper battery key to install or disassemble the battery in the bottom of the calibrator.

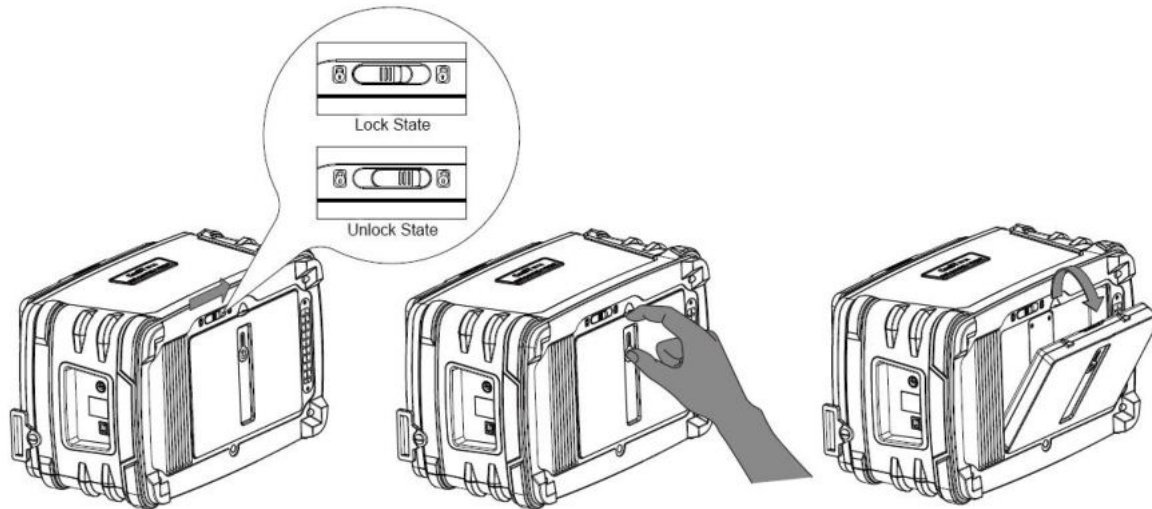

Figure 2- 3 Battery installation

2.2.2 Changing the shoulder strap

As shown in Figure 2-4, change the Shoulder strap with a slotted screwdriver.

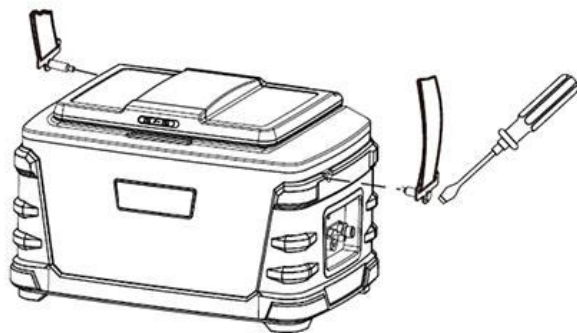

Figure 2- 4 Changing the shoulder strap

2.2.3 Pressure connection

As shown in Figure 2-5, 2-6, under the situation of UUT is connected, the output port shall be sealed with the corresponding accessories.

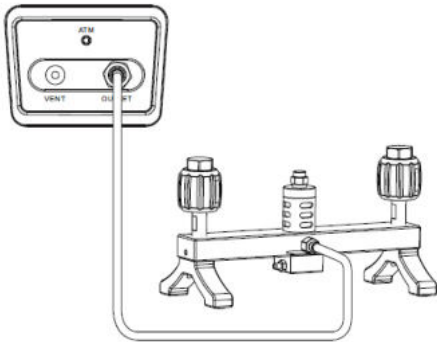

Figure 2- 5 Gauge pressure connection

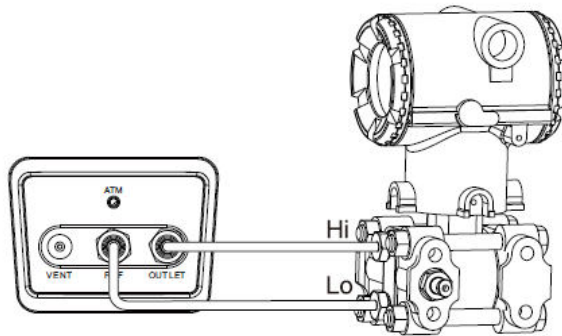



Figure 2- 6 Low pressure and differential pressure connection

2.2.4 View the display

Push the front lock to the right and raise the screen to the proper position

2.3 Getting started

2.3.1 Power on

- ◆ Press  to turn the power on.
- ◆ The startup screen shows the manufacturer's logo.
- ◆ After a short time the system enables the home screen.
- ◆ Connect the power supply for charging if power is low.
- ◆ If calibrator is charging, the screen will dim, press  turn it on.

2.3.2 Setting the system date and time

- ◆ Refer to section 4.6.1 to set date and time

2.3.3 Generating a pressure

At the home screen, enter the desired pressure value using the numeric keypad, press enter and calibrator will generate and control to the target pressure (see section 3.2.1)

2.3.4 Display and operation

Touchscreen display makes operation easier, supports keypad operation, is convenient to operate and input values quickly.

3. Display and Operation

3.1 Home screen

The home screen contains top status bar and module function areas, see figure 3-1 shows

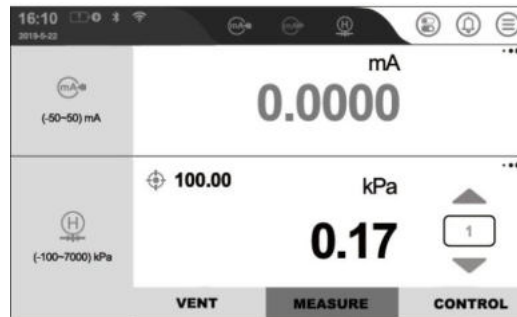









Figure 3- 1 home screen

3.1.1 Status bar



The status bar contains three parts, status information, module display/hidden operation and function navigation.

1. Status information display area

- ◆ Date and time: the time is system time
- ◆ Wi-Fi: Image  indicates connection status and signal intensity.
- ◆ LAN connection: Image  indicates network activity.
- ◆ USB: Image  indicates USB device activity
- ◆ Bluetooth: Image  indicates Bluetooth function is working.
- ◆ Cloud service: Image  indicates cloud service is working, image  indicates cloud service is enabled, but has lost connection.
- ◆ Snapshot: Image  indicates snapshot function is operating.

2. Module function display/hidden operation area

Modules can be displayed or hidden by clicking the corresponding function icon. When the module is in the display state, the icon is highlighted, when the module is in the hidden state, the icon is dim.

Electrical measurement module display/hidden: Icon will be displayed according to electrical measurement. When the  icon shows, it indicates the mA measurement is displayed. Click  icon, then click measure function, the icon will become dim.

Electrical output module display/hidden: Icon  will be displayed according to electrical output. When electrical signal is outputting, the arrow on the icon will be flickering.

Pressure output module display/hidden: Icon  and  will be displayed according to pressure control range.

External pressure module A display/hidden: Icon  will be displayed when pressure module A is connected.

External pressure module B display/hidden: Icon  will be displayed when pressure module B is connected.

3. Navigation function area

- ◆ Control center: Click icon  to enter the control center. The control center has many functions, such as internal pressure module, electrical measurement signal, electrical output signal, external module A, external module B, positive pressure air source and negative pressure air source, lock screen function, Bluetooth communication and Wi-Fi communication open and close and so on.

- ◆ Notification center: when exceptions happen, The icon  will turn to red and highlight. Click the icon to know more information about the exception.





- ◆ Main menu: Click icon , the main menu provides system configuration, HART communicator, quick test, task and application functions and so on.











3.1.2 Module and split screen display area

The module function display area is divided into electrical signal measuring area, electrical signal output area, external pressure module A and B (once pressure modules are inserted). By clicking "Module function display/hidden operation area" in the status bar, above functions display areas can show and hidden, at the same time, module function can set screens' quantity from one to five.

- ◆ Pressure output area: see section 3.2 pressure output.
- ◆ Electrical signal measuring area: see section 3.3 electrical signal measuring .
- ◆ Electrical signal output area: see section 3.4 electrical signal output.
- ◆ External pressure module A & B areas: see section 3.5



3.1.3 Main interface keypad operation

◆ By click  and  on main interface , you can choose each function area icon, showing orange frame. Press  to trigger corresponding function, press  to quit corresponding function.

◆ Press  ~  /  /  to type targeted value in pressure output area , then press  to generate and control to that pressure. Press  /  to adjust targeted value. If the pressure output is hidden and the electrical signal output area is displayed, press  and enter to electrical output area or press  /  to adjust electrical output value.

3.2 Pressure control

3.2.1 Pressure output

1. Click  or  to open internal pressure control on status bar: High pressure range and low pressure range.
- ◆ Click on the high or low pressure icon on the left status bar to switch the internal pressure module.
2. Connection: See figure 3-2 and 3-3 as shown:

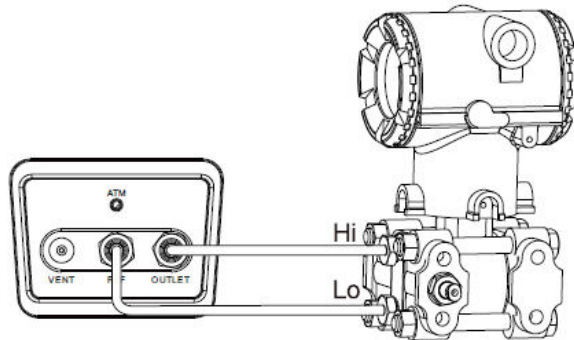

Figure 3- 2 Differential pressure outlet

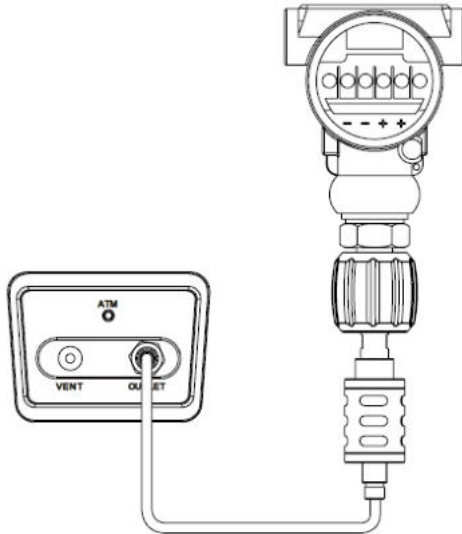

Figure 3- 3 Gauge pressure outlet

3. Input target value

- ◆ Pressure output area, touch screen to enter value or press **0** ~ **9** / **±** / **.** button on the main interface , then press **Enter** for confirmation.
- ◆ Press **▲** / **▼** to increase or decrease the pressure target by the predetermined step size.
- ◆ ◆ The maximum negative pressure depends on current barometric pressure and the ability of the internal pump to generate this pressure. Meanwhile, the maximum pressure value depends on the control setting configuration (see



section 4.1). If the target pressure exceeds the limit, then the calibrator will error and allow for another pressure to be entered.

- ◆ When target pressure exceeds current pressure range of the internal module but is within the range of the second internal module, it will switch to the applicable module.

4. Start /stop controlling pressure

- ◆ The Calibrator will start controlling after the target pressure value is achieved.

- ◆ On the status of vent or measure, click  or “control” button on the screen to start controlling to the target pressure.

- ◆ Press  ,  or click “vent” and “measure” button on the screen to stop control.

5. Pressure stability

- ◆ When stable within the control settings, the displayed pressure value will change from white to green.

6. Auto step



- ◆ Press  to enter into auto step setting interface, see parameter in figure 3-1:

Item	Effective value	Description
Stroke	Round trip or one way	Setting travel mode of auto step
Loop time	0-100	Setting loop time of auto step
Step mode	Step point, percent, unit, default	Incrementing mode of auto step
Cycle interval	0-3600 seconds	Stop time between every cycle end and the next cycle start
Dwell time	0-3600 seconds	The time is pressure stable at each step

Step quantity	2-17	The number of steps
Range	Range will be based on the largest range internal module	Setting auto step output range
Point list	Point list is read only except when "Custom" is selected for Step mode	Shows the pressure points of the auto step routine

Table 3- 1 setting interface

7. Manual step

◆ Press  /  or click  on screen to achieve pressure output manual step.

◆ Click the middle number on icon  to set up manual step value. The icon will be present when the split screen display shows only one or two fields.

3.2.2 Pressure measurement

1. Open internal pressure control item to switch pressure measurement: High or Low pressure range

◆ When changing internal module ranges the calibrator will open to atmosphere and then change ranges

2: Connection: figure 3-4

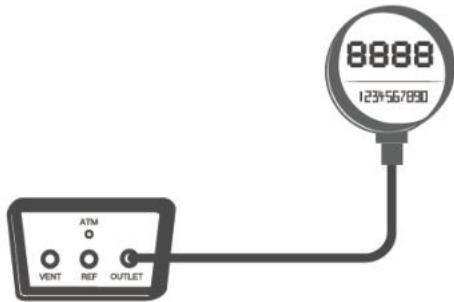

Figure 3- 4 Pressure Measurement

3: External pressurization

- ◆ Do not pressurize the calibrator beyond the measuring module range.
- ◆ When external pressure exceeds the current range, the value turns red and alarms at the same time.
- ◆ If the external pressure exceeds the maximum range, the system will immediately vent .

3.2.3 Pressure unit



- ◆ When the item of pressure output, pressure measurement or external pressure module is selected, click the pressure unit area on the screen to select a the desired unit.

3.3 Electrical signal measurement

The electrical signal measurement area provides such functions as current measurement, voltage measurement,

switch testing, HART communication and Profibus PA communication. Click the item icon and range at the left measurement area to switch the electrical measurement.

3.3.1 Current/Voltage measurement

1. Click the input icon  or  on the status bar to display the electrical measurement. Click the range area on the screen to switch the electrical measurement or range.

- ◆ Do not apply current/voltage outside the calibrator's range.
- ◆ Short-circuit zeroing is allowed.
- ◆ If the measured value exceeds the present range, it will turn red and give an alarm.
- ◆ If the measured value exceeds the measurable range of calibrator, it will display red "-----" and give an alarm.

2. Connection: Connect the electric circuit as shown in Figures 3-5 and 3-6.

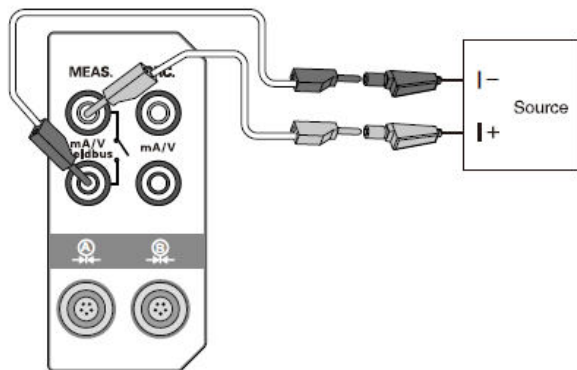

Figure 3- 5 Current measurement

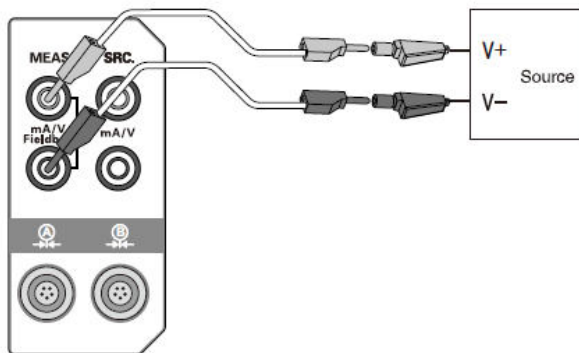

Figure 3- 6 Voltage measurement

3. Functional operation

- ◆ Zeroing: Zero the measurement to eliminate drift. The allowable zeroing range is 1%FS.
- ◆ Scaling: Converts the current/voltage signal into pressure signal for display.

Item	Effective value	Description
Transfer function	Linear, square root, square	Type of the conversion function of the scaled value
Input range	0%~100%	Percentage of the input range of scaling
Unit	Depend on the electrical measurement selected	Input unit of scaling
Output range	0%~100%	Percentage of the output range of scaling
Unit	User-editable field.	Output unit of scaling
Resolution	1, 0.1, 0.01, 0.001	Resolution of scaling

Table 3- 2 Scaling parameters

- ◆ Filter: Provides a first order linear filter and a moving average filter. The moving average filter also allows setting the extremum pair.

Item	Effective value	Description
Filter type	First-order filter and average filter	Select the filtering mode.
Coefficient	0.01~1	Applicable to the first-order filter.
Filter sampling number	Integer 1~100	Sampling number of the average filter, correlated with the sampling time.
Filter sampling time	0~20sec	Sampling time of the average filter, correlated with the sampling number.
Extremum pair number	Integer 0~10	Extremum pair number of the average filter

Table3- 3 Filtering parameters

- ◆ Resolution: Allows setting digit resolution.
- ◆ Stability: Allows setting the stability of measurement data.
- ◆ Loop power supply: Applicable only for the current measurement. Select enabling/disabling loop power supply.

3.3.2 Switch test

1. Similar to 3.3.1, open the electrical measurement options, click the range area on the screen, and select  for switch test. The calibrator can test three types of switches, i.e. mechanical switch, NPN electronic switch and PNP electronic switch.

2. Connection

- ◆ If mechanical switch is selected, connect the electric circuit as shown in Figure 3-7.

- ◆ If NPN electronic switch is selected, connect the electric circuit as shown in Figure 3-7.
- ◆ If PNP electronic switch is selected, connect the electric circuit as shown in Figure 3-7

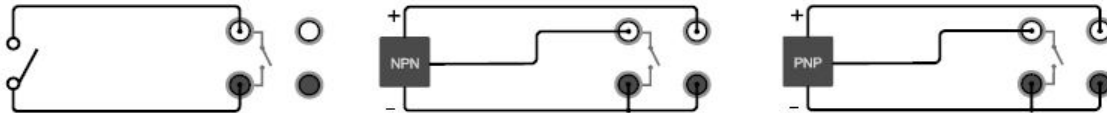

Figure 3- 7 Switch testing

- ◆ The switch action values are recorded only when the output item is pressure.
- ◆ Only a pair of action values is recorded, including the switch state (on to off/off to on) when triggered and pressure value.
 - ◆ Press **•••** and select "Reset", to clear the action values.
 - ◆ Press **•••** and select "Switch Setup", to switch between mechanical switch, NPN switch and PNP switch.

3.3.3 HART Communication

The calibrator supports HART bus communication, uses simplified DD files, and provides setting maintenance and calibration for general and common parameters of HART pressure transmitters. Before using the calibrator to operate the transmitter, please refer to the user manual of transmitter. If you need full-featured HART operation, please refer to Chapter VII "HART communicator".

Note: During communication with a HART device, the calibrator acts as a master station all the time. To avoid damaging the control system, you must separate the HART device from the control system before connecting the calibrator to HART device.

1. Search and connection

◆ Under the main operation interface, open the electrical measurement area for display. Select  in mode switching to enable the HART function. The calibrator will automatically switch to power configuration selected previously (connection mode of internal power supply and internal resistance by default), and search for the address "0". When a HART device is found, the calibrator will automatically connect to it and display its reading.

◆ Press **•••** and select "Search", or click the HART measurement channel screen when no HART device is connected, to enter the HART power configuration interface. The calibrator provides the following connection mode:

- 1) For the connection mode with internal power supply and internal resistance, see Figure 3-8.
- 2) For the connection mode with external power supply and internal resistance, see Figure 3-8.
- 3) For the connection mode with external power supply and external resistance, see Figure 3-9.
- 4) For the connection mode with internal power supply and external resistance, see Figure 3-9.



Figure 3- 8 HART connection

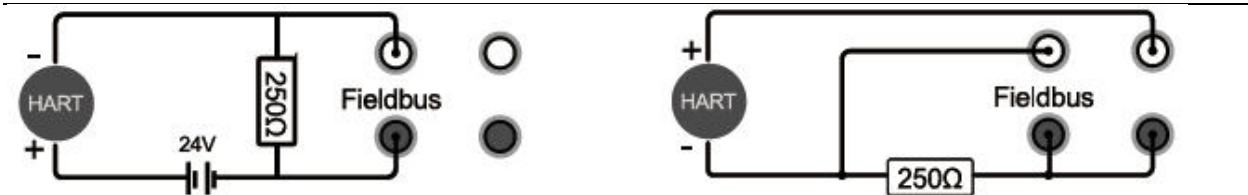

Figure 3- 9 HART connection

- ◆ After the power supply configuration is selected, you will enter the search interface. Start searching HART devices from the address "0". If successful the connection will be made and the HART device will be displayed. If no connection is established the calibrator will continue to search from the address "1" until "15". After the search is complete, the calibrator will list all the HART devices found, and can support at most 15 HART devices at the same time.

- ◆ During the search process, you can press the **Esc** key to stop searching and return to the power configuration interface.

- ◆ After searching is finished, you can press the **Q** key to conduct a new search.

- ◆ After searching is finished, if any HART device is online, press the **▲/▼** key to select it, then press the **Enter** key to confirm establishing connection with this device; press the **...** key and select "Setup" to read main information of the selected device.

2. Online/offline

- ◆ After connection is established, HART will be displayed as electrical measurement item on the main interface.

- ◆ Under the main interface, when electrical measurement is switched to other measurement





mode (e.g. current measurement), it will exit HART connection. Meanwhile, the HART measurement icon in the status bar will change to a corresponding icon (e.g. current measurement).

- ◆ Under the main interface, if HART communication fails, it will automatically search new devices again.

- ◆ During a test with HART, the test will give a prompt if the HART is offline.

3. Process quantities

- ◆ On the main interface, HART acts as an electrical measurement item. Press **•••** to enter process quantities. It can display the primary variable PV, output current A0, percentage, second variable, third variable and loop current at the same time, in which the units of second variable and third variable are determined by different devices.

- ◆ In the process quantity menu, press the / key or click the screen to select, and then press the  or  key for confirmation, so as to switch primary and secondary display.

- ◆ During task calibration of a HART transmitter, you shall first select the HART process quantity to be calibrated.

4. Setup

(1) Parameters







- ◆ Under the main interface, switch to HART electrical measurement. Press **•••** to enter setup. Then, you can view and set HART parameters. See Table 3-4.

Item	Parameter	Description and effective value
Device information	Label	Support input of letters, numbers and symbols, no longer than 8 characters.
Device information	Date	It can be modified to any date supported by the transmitter.
	Information	Support input of letters, numbers and symbols, no longer than 32 characters.
	Description	Support input of letters, numbers and symbols, no longer than 16 characters.
	Final assembly number	Support input of integers, no longer than 8 digits.
	Pilot symbol number	Support input of integers from 5 to 20.
	Manufacturer	Read-only parameter
	Device type	Read-only parameter
	Device number	Read-only parameter
	Write protection	Read-only parameter
	Common version	Read-only parameter
	Software version	Read-only parameter
	Hardware version	Read-only parameter
	Device version	Read-only parameter
Sensor	Sensor S/N	Read-only parameter

	Sensor unit	Read-only parameter
	Lower sensor limit	Read-only parameter
	Upper sensor limit	Read-only parameter
	Minimum sensor range	Read-only parameter
Device output	Primary variable/range unit	It can be modified to any unit supported by the transmitter. During modification, the upper and lower limits are displayed through conversion.
	Pv lower range limit	Not exceed the lower sensor limit.
	Pv upper range limit	Not exceed the upper sensor limit.
	Conversion function	It can be modified to linear or square root.
	Damping	Device data filtering time, in the unit of S
	Polling address	0 by default, support input of integers from 0 to 15.
	Emergency mode	It can be set to Enable/Disable, depending on whether the transmitter supports it or not.
	Emergency command	The emergency command value can be set.
	Alarm state	Read-only parameter



Table 3- 4 Hart Parameters

2) Operation

- ◆ Under the HART setup interface, you can press the  key to view HART parameter values in real time; select a parameter that can be set, then press the  key or click the screen to enter the set state.
- ◆ After input is complete, press the  key or click  on the screen to save it; press the  key or click  on the screen to cancel saving and return.
- ◆ If the input value is displayed in red when saving, it indicates that the input value is invalid. Please check its input range.
- ◆ If the present setting is cancelled or setup fails, the present item will be resumed.

5. Maintenance

1) Current loop test

- ◆ Click  and select "Diagnosis/Service", to enter current loop testing. Use number keys to input or press the right side to select a test current value. Then press the  key to perform a current loop test. The value range of this parameter is 4-20 mA.
- ◆ The HART measured value at the left bottom of calibrator interface is the real value of current loop.

2) Primary variable zeroing

- ◆ Select "Zero" on the HART diagnosis/maintenance interface. Then select a pressure module

to enter the zeroing interface.

- ◆ Ensure that the present measured value adequately approaches zero; otherwise, it may cause zeroing to fail.

3) Current regulation

- ◆ Adjust the proportion of current output of the transmitter, to make its AO value consistent with the actually output loop current.

- ◆ Provide regulation of the D/A zero (4mA) and D/A gain (20mA). You can press the screen to acquire the present value, and press the  key to perform regulation.

4) Sensor trim

Sensor trim is to adjust the PV process variable of the transmitter, generally including one or two trim points (lower point and upper point). Some transmitters do not support the sensor trim operation (as for whether the transmitter supports sensor trim, please refer to the user manual of transmitter).

- ◆ Lower trim

Support setting the PV unit and trim point value. You can select two pressurization methods, internal and external pressurization. Press the  key to enter the execution interface.

Note: External pressurization requires an external pressure module.

- 1) Internal pressurization: Select high-pressure and low-pressure modules, to automatically output the pressure of the trim points. Wait for the pressure to stabilize and press the "Get" key to directly acquire the value, or manually enter the trim values.

- 2) External pressurization: Manually control the pressure of transmitter through an external source. Wait for the pressure to stabilize and press the "Get" key to directly acquire the value, or manually enter the trim values.



Note: Some transmitters may not allow selectable trim values, and automatically use the upper and lower range limits as trim values (the lower range limit corresponds to the lower-point trim value, and the upper range limit corresponds to the high-point trim value). In this case, you can input any value.

3) Execute the adjustment (Trim) command. After completed successfully, the PV value will change with the executed trim point value.

- ◆ Upper trim

The operation procedure of upper trim is the same as that of lower trim.

- ◆ Factory reset

Select "Factory Reset", then a prompt will ask "Are you sure to restore factory settings of the sensor?" Press the  key or click  on the screen to execute the factory reset command. After completed successfully, the upper and lower trim values will restore factory settings.

3.3.4 PROFIBUS PA communication

The calibrator supports PROFIBUS PA bus communication. It can set and calibrate the parameters of PROFIBUS PA pressure transmitter (PA transmitter). Before conducting any operation to the PA transmitter, you shall understand relevant terms of PROFIBUS PA protocol such as Physical Block, Transducer Block, Function Block, TARGET_MODE, AUTO, OSS and Man. Before use, please refer to the user manual of transmitter.



Note: During communication with a PA transmitter, the calibrator acts as a master station all the time. To avoid damaging the control system, you must separate the PA transmitter from the control system

before connecting the calibrator to PA transmitter.

1. Device description file

The device description file is used to describe device parameters and parameter access modes. Through the parameter description information, you can view and set related parameters of the PA transmitter. The calibrator uses specific device description files, to access main parameters in the Physical Block, Transducer Block and Function Block of PA transmitter. This calibrator includes device description files of common mainstream PA pressure transmitters. If you need to add new device description files of transmitter, please contact us.

2. Connection and search

- ◆ For the connection mode, please refer to Figure 3-10.
- ◆ Click the  icon to start searching; and click the  icon to stop searching.
- ◆ From the searched PA device list, click a PA device to be connected. After connection is successful, return to the main interface.

3. Process quantities

Click  , then a function menu will pop up. Select "Process Quantity" in the function menu. The calibrator provides switching between display of process quantities such as PRIMARY_VALUE, SENSOR_VALUE, SECONDARY_VALUE_1, TRIMMED_VALUE, SECONDARY_VALUE_2 and STATIC_PRESSURE_VALUE.

4. Transmitter operation

(1) Setup

- ◆ After clicking  , a function menu will pop up. Select "Setup" in the function menu to enter the setup interface.

◆ On the setup interface, you can access and set parameters in the Physical Block, Transducer Block and Function Block.

◆ Before modification of some parameters, you may need to modify corresponding TARGET_MODE (e.g. set it to OOS, Auto, Man, and so forth). Specifically, you can follow the user manual of PA transmitter to modify related parameters.

(2) Calibration

◆ Click *******, then a function menu will pop up. Select "Calibrate" in the function menu to enter the calibration interface.

◆ You can calibrate the PA transmitter on the calibration interface. Before performing calibration on the PA transmitter, please refer to relevant description of adjustment (Trim) part in the user manual of PA transmitter.

3.4 Electrical output

You can click a corresponding electrical output icon in the module display/hide operation area on the top status bar, to display/hide the electrical signal output module. When the electrical output is displayed, the corresponding icon on the status bar will be highlighted. When the electrical output is hidden, the corresponding icon will be dim and when signals are output, the output arrow on the icon will flicker.

1. Changing the range





Click the range area on the left side of the measurement area to switch the output item. The calibrator supports 0~25mA, 0~16V and 16~30V power output.

2. Connection: Connect the electric circuit as shown in Figure 3-14.

3. Enabling loop power (for current supply only)

- ◆ According to the connection mode, press the  key and select whether to enable loop power.
- ◆ Power will be supplied as soon as loop power is enabled.

4. Input of the target set value

- ◆ When the pressure output module is hidden, press the  key to enter the setup interface of electrical output values; when the pressure output module is hidden, press the / key or press the  key on the screen to realize step output of current, and set the step value inside .
- ◆ The set value shall meet the calibrator's current output range of 0~25mA, voltage output range of 0~16V, and power output range of 16~30V.

5. Auto step

Press the  key to enter the auto step setup. For the auto step parameters, see Table 3-5.

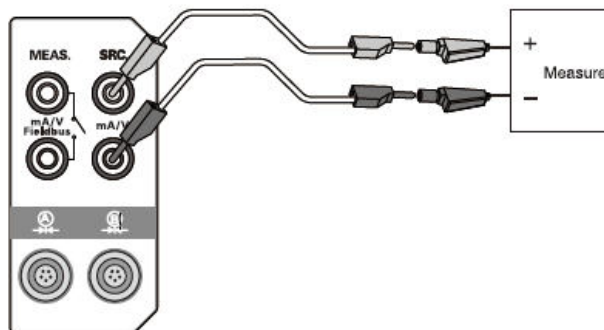





Figure 3- 10 Current output of internal power supply

Item	Effective value	Description
Stroke	Round trip or one way	Set the trip pattern of auto step.
Cycle number	0-100	Set the cycle number of auto step.
Step mode	Step point, percentage, value, or custom	Set the mode of automation step.
Cycle interval	0~3600 sec	Standing time between the end of each cycle and the start of next cycle.
Dwell time	0~3600 sec	Standing time after the present electrical output becomes stable.
Step point number	2-17	It can be set when the step mode is step point.

Range	Not to exceed the electrical output range.	Set the output range of automatic step.
Step point list	Editable when the step mode is custom; read-only and displayed under other modes.	Display the set point list of automatic step.
Step value	6.25%" 00%	It can be set when the step mode is percentage.
Step value	1.5625~25mA	It can be set when the step mode is value.

Table 3- 5 auto step parameters

6. Manual step

◆ Press the /  key on the keyboard or  on the screen, to manually step through values.

◆ You can click the number inside  to set the step value of manual step.

7. Ramp

Press the  key to enter the Ramp setup interface (only 0~25mA and 0~16V is applicable).

For the Ramp output parameters, see Table 3-6.

Item	Effective value	Description
Range	Do not exceed the electrical output range	Set the ramp output range.

Rise time	4~60 sec	Ramp rise time
Fall time	4~60 sec	Ramp fall time
0% wait time	1~60 sec	Wait time of the slope at the lower range value.
100% wait time	4~60 sec	Wait time of the slope at the upper range value.
Repeat	0-100	Set the cycle number of slope. 0 indicates infinite repetition.

Table 3- 6 Ramp parameters

3.5 External pressure module

1. Connection: Connect the external pressure module as shown in Figure 3-11.

2. Display of the external pressure module

- ◆ When the pressure module is connected properly, the status bar will display the online icon of pressure module. The calibrator supports two external pressure modules A and B, and provides multi-screen display with other parameters. When the external pressure modules A and B are both connected, the calibrator can show up to five items in the multi-screen.

- ◆ If the measured value exceeds the present range of pressure module, it will turn red and give an alarm.

- ◆ If the measured value exceeds the measurable range of pressure module, it will display red "-----" and give an alarm.

3. Related operations of external pressure module

- ◆ The pressure unit can be switched.
- ◆ The atmospheric pressure version can switch the pressure type.

- ◆ Press **•••** to invoke the function menu. Select "Measurement Stability", to set the stability time and degree.
- ◆ Zeroing is allowed.

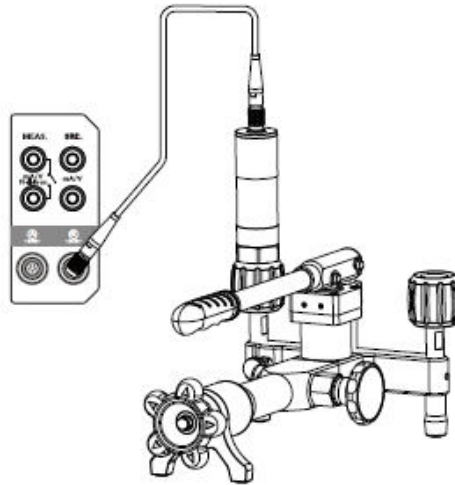

Figure 3- 11 Connection of the external module

- ◆ Select "Module Information", to view related information of the external pressure module.
- ◆ Select "Resolution", and set the number of digits displayed to 4, 5 or 6.
- ◆ Select "Filter". Then, you can select first-order filter or average filter as the filter type, and set related parameters.

3.6 Typical applications

3.6.1 Pressure gauge

1. Prepare

- ◆ Open the pressure output area of main operation interface: High-pressure or low-pressure range (depend on the range of calibrated instrument).

2. Connection

- ◆ Connect the gauge as shown in Figure 3-12.
- ◆ When the calibrated instrument is a differential pressure gauge, connect the REF port properly. For the connection mode, see Figure 3-2 Differential pressure output.

3.

Manually set or use the step function (see Section 3.2.1 "Auto step and manual step of pressure output") to output the pressure of each calibration point.

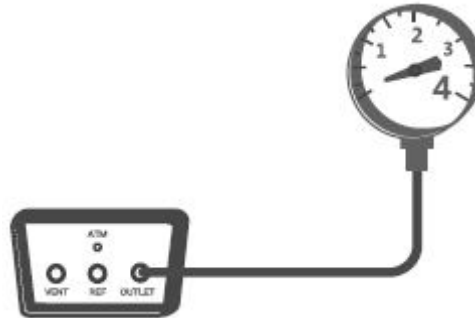

Figure 3- 12 Calibration of a pressure gauge

4. When the pressure of each calibration point becomes stable and is displayed in green, record the readings of each point.

3.6.2 Pressure transmitter

The calibrator supports calibration of 2-wire, 3-wire and 4-wire pressure transmitters.

1. Prepare

- ◆ Open the pressure output area of main operation interface: High-pressure or low-pressure range (depends on the range of the transmitter).
- ◆ Switch the electrical measurement item of main operation interface to: Current or voltage measurement (depend on the output signal of the transmitter).

◆ If the current-type 2-wire pressure transmitter needs loop power supply, you shall enable loop power supply in the current function menu.

2. Connection

- ◆ For a 2-wire pressure transmitter connect as shown in Figure 3-13.
- ◆ For a 3-wire pressure transmitter, connect as shown in Figure 3-14.
- ◆ For a 4-wire pressure transmitter, connect as shown in Figure 3-15.
- ◆ If the transmitter is a differential pressure transmitter, you shall connect the REF port properly.

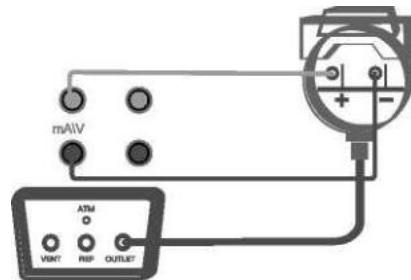

Figure 3- 13 Calibration of a 2-wire pressure transmitter

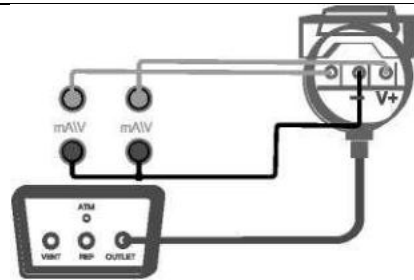

Figure 3- 14 Calibration of a 3-wire pressure transmitter

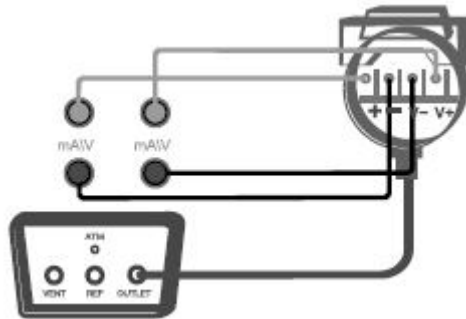

Figure 3- 15 Calibration of a 4-wire pressure transmitter

3. Manually set or use the step function (see Section 3.2.1 "Auto step and manual step of pressure output") to output the pressure of each calibration point.
4. When the pressure of each calibration point becomes stable and is displayed in green, record the output value of the transmitter at each point, or use the snapshot feature.

3.6.3 HART transmitter

1. Prepare

- ◆ Open the pressure output area of main operation interface: High-pressure or low-pressure range (depends on the range of the transmitter).

- ◆ Switch the electrical measurement item of main operation interface to: Current measurement

2. Connection

- ◆ Connect the transmitter as shown in Figure 3-17; connect the electric circuit as shown in Figure 3-10, 3-11, 3-12 or 3-13.

3. Establish connection (see Section 3.3.1). During setup, switch the process quantity to current output.

4. Press the setup icon, to set the parameters of the HART transmitter (see Section 3.3.3).

5. Press the setup icon, to maintain the process quantities of the HART transmitter (see Section 3.3.3).

6.

Manually set or use the step function (see Section 3.2.1 "Auto step and manual step of pressure output") to output the pressure of each calibration point.

7. When the pressure of each calibration point becomes stable and is displayed in green, record the output value of the HART transmitter at each point, or use the snapshot feature

3.6.4 Pressure switch

1. Prepare

- ◆ Open the pressure output area of main operation interface: High-pressure or low-pressure range (depends on the range of the switch)

- ◆ Switch the electrical measurement item of main operation interface to: Switch measurement

2. Connection

- ◆ Connect the switch as shown in Figure 3-16 (it is a mechanical switch in the figure. If the tested switch type is NPN or PNP electronic switch, please connect the electric circuit as shown in Figure 3-8 or 3-9).

3. Capture of the action value

- ◆ To capture more accurate action values, you can enter "control settings" and set the slew rate to a lower value which will reduce the lag time between the calibrator and the switch.

- ◆ Separately use the upper and lower range limits of switch as the target value for pressure control until the switch acts. Then, capture and display the action value.

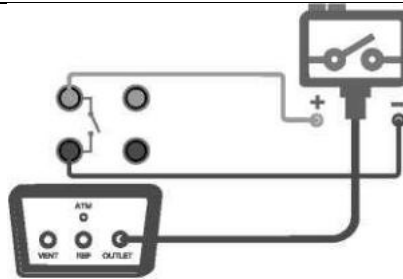

Figure 3- 16 Calibration of a pressure switch

4. Record the captured action value, or use snapshot storage (it can store a pair of action values at the same time).

3.6.5 I/P converter

1. Prepare

- ◆ Switch the electrical output item of main operation interface to: Current output.
- ◆ Open the pressure output area of main interface and switch to the measurement state: High-pressure or low-pressure range (depends on the range of the I/P converter).
- ◆ The output pressure of I/P converter can be measured by using an external pressure module.

2. Connection

- ◆ Connect as shown in Figure 3-17.
- ◆ Never apply pressure out of the present range of the calibrator.

- ◆ Never use the calibrator for pressurization.
 - ◆ If the loop power supply of calibrator is used (the maximum load is 50 mA), please check the load capacity.
3. The I/P converter shall use the manual or automatic step function of electrical output (see Section 3.4 Automatic and manual step of electrical output), to successively output current of each calibration point.
4. When each measured pressure value becomes stable, record the output value of I/P converter at each point, or use the snapshot feature.

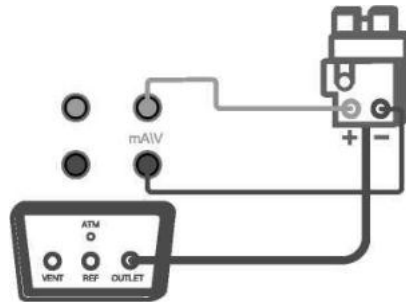



Figure 3- 17 Calibration of an I/P converter

4. System setup

Under the main interface, press the  key to enter the system setup interface. Or click  on the screen, then a main menu will pop up. Select " Set up" on the main menu to enter the system setup interface. System setup includes control setting, communication, power management, calibration, service, personalization, cloud service, data management and product information.

4.1 Control settings

1. Pressure type

- ◆ The ADT761A-500 and ADT761A-1K support switching between gauge pressure and absolute pressure.

2. Slew rate limit

- ◆ If disabled, the calibrator will approach the target value at the maximum control speed.
- ◆ If enabled, you need to set an upper slew limit. During pressure control of the calibrator, the maximum control speed shall not exceed this limit.

3. Stability

- ◆ Input the pressure stability: One of pressure stability conditions. Compare the difference between the output pressure and set pressure with this value. Its range is $\pm(0.003\sim 1)\%FS$.

4. Stabilization time

- ◆ Input the pressure stabilization time: One of pressure stability conditions. Pressure control is considered stable when the difference between the output pressure and set pressure meets requirements and lasts for this duration. Its range is 1~60sec.

- ◆ The pressure can be judged stable when the following two conditions are met during control:

1) (Out put pressure-set pressure) \leq High-pressure/low-pressure range X pressure stability

2) Meet the condition 1) continuously and reach the pressure stabilization time.

5. Automatic zeroing

- ◆ Can be enabled or disabled.

- ◆ If enabled, the calibrator will automatically perform pressure zeroing when vented to the atmosphere.

6. Vent pressure

- ◆ Allowable setting range of the vent pressure: Depend on the device model.

- ◆ Press the “Vent” key to vent. If the pressure is lower than this value, the calibrator will open the vent valve for direct connection to the atmosphere. If the pressure is higher than this value, the calibrator will control the pressure below this value and then open the vent valve for direct connection to the atmosphere.

7. Head correction

- ◆ The correction type can be selected from: auto or fixed.

- ◆ The unit can be selected from: metric (SI) or imperial (BS)

- ◆ The density can be selected from: air, nitrogen or user-defined value;

- ◆ The height can be input within the range of (-1000~1000) cm.

- ◆ The acceleration can be input within the range of (9~10) m/s².

- ◆ The temperature can be input within the range of (0~100) °C.

8. Set point limit

- ◆ Input a range smaller than the calibrator range as the upper and lower limits of pressure control, to ensure that the pressure output to the calibrated device does not exceed its range, thereby

protecting the calibrated device.

- ◆ If disabled, this function is invalid. The setting will be stored by the calibrator and still effective after reboot.

- ◆ If enabled, the target value of pressure control of the calibrator is restricted by this condition. When exceeding this condition, the calibrator will give a prompt that the set point limit is enabled and the designated pressure cannot be outputed.

4.2 Communication

The calibrator supports three communication modes: Ethernet, Wi-Fi and Bluetooth (BLE).

4.2.1 Ethernet

The calibrator is connected via network cables to computers for communication.

Item	Effective value	Description
Address acquisition	DHCP/static	Select the acquisition mode of device address.

Table 4-1 Network connecting

- ◆ When the DHCP mode is selected, the content of the table below will be allocated by the system automatically and are read-only items.

- ◆ When the static mode is selected, the following table needs to be completed manually.

Item	Effective value	Description
I/P address	0.0.0.0~255.255.255.255	Set the IP address of calibrator host.
Subnet mask	0.0.0.0~255.255.255.255	Set the subnet mask of calibrator host.
Gateway	0.0.0.0~255.255.255.255	Set the source gateway of calibrator host.

Table 4-2 static mode selection

- ◆ The port number and physical address are factory settings and cannot be modified.
- ◆ Click the  button at the lower right corner of screen confirms and saves the settings.

4.2.2 Wireless communication

The calibrator is connected via a wireless network.

Item	Effective value	Description
I/P address	0.0.0.0~255.255.255.255	Set the IP address of calibrator host.
Subnet mask	0.0.0.0~255.255.255.255	Set the subnet mask of calibrator host.
Gateway	0.0.0.0~255.255.255.255	Set the source gateway of calibrator host.

Table 4-3 Wireless network selection

- ◆ The port number and physical address are factory settings and cannot be modified.
- ◆ When the static mode is selected in advanced options, the following table needs to be

completed manually.

Item	Effective value	Description
I/P address	0.0.0.0~255.255.255.255	Set the IP address of calibrator host.
Subnet mask	0.0.0.0~255.255.255.255	Set the subnet mask of calibrator host.
Gateway	0.0.0.0~255.255.255.255	Set the source gateway of calibrator host.

Table 4-4 Setup of wireless communication

- ◆ Click the  button at the lower right corner of screen to confirm and save the settings.
- ◆ The setting of wireless communication will take effect immediately, with no need for confirmation. Click 5 at the upper right corner of screen, to return to the previous menu.

4.2.3 Bluetooth

The calibrator is connected through Bluetooth to mobile APPs for communication.

Item	Effective value	Description
Bluetooth state	Enable/disable	Enable or disable the Bluetooth function.
Bluetooth name	Support Chinese characters, letters, numbers or symbols.	Set the Bluetooth name of calibrator.
Physical	Read-only	

address		
---------	--	--

Table 4-5 Bluetooth setup

4.3 Power management

4.3.1 Display brightness

The LCD brightness of calibrator can be modified by adjusting the brightness progress bar.

4.3.2 Battery information

Display the present connection state and information of the battery.

4.3.3 Energy settings

The energy settings can prolong the service life of the battery by setting the auto-backlight time, auto-sleep time and auto-shutdown time.

1. Backlight time

- ◆ In case there is no key and serial port command operations within a set time, the backlight brightness will be automatically set to the lowest value.

- ◆ There are 6 types of setting: never, 30 sec, 1 min, 5 min, 15 min, and 30 min.

- ◆ When the backlight is turned off, the first key-press will resume the backlight brightness, only after which subsequent key-pressing can take effect normally.

- ◆ During pressure control, auto step or task execution, this function does not take effect.

2. Auto sleep

- ◆ In case there is no key and serial port command operations within a set time, it will

automatically sleep.

- ◆ There are 4 types of auto-sleep setting: never, 1 min, 5 min and 30 min.
- ◆ If connected to a power adapter, the calibrator does not support auto sleep.
- ◆ During pressure control, auto step or task execution, this function does not take effect.
- ◆ When the backlight off time is set to "never", the auto-sleep setting is invalid.

3. Auto power off

- ◆ In case there is no key and serial port command operations within a set time, it will automatically shut down.
- ◆ There are 5 types of auto power off settings: never, 5 min, 15 min, 30 min, 1 hour and 2 hours.
- ◆ If connected to a power adapter, the calibrator does not support auto power off.
- ◆ During pressure control, auto step or task execution, this function does not take effect.
- ◆ When the backlight off time or auto sleep time is set to "never", the setting of auto power off is invalid.

4.4 System calibration

- ◆ The electrical measurement, electrical output and internal pressure modules of this calibrator all need periodic calibration.
- ◆ This calibrator can also provide calibration for external pressure.
- ◆ Before calibration, please carefully read the user manual, and perform operation after you have understood it.
- ◆ Improper calibration will affect the accuracy of calibrator, and in severe cases, may affect

normal working of the calibrator.

- ◆ Provided is a factory reset function to restore calibration data to factory settings. When performed the calibration date is restored to "----/--/--".

- ◆ You need to use a standard device with higher accuracy for calibration.

- ◆ On the setup interface, enter system calibration and select an item to be calibrated.

- ◆ To avoid mis-operation, this operation needs a password for confirmation. The password is "123456".

- ◆ After the calibration of the last point is completed, confirm and save it. The new calibration data will take effect and be used. The former calibration data will be deleted permanently.

- ◆ The calibrator provides a calibration notification warning. The default calibration period is 365 days. After a specific module of calibrator exceeds the calibration period, it will give a prompt when the calibrator is powered on or the module is online. You can enable/disable the warning function or modify the calibration period on the setup interface of calibration expiry warning.





4.4.1 Calibration of electrical measurement

1. Set the calibration points

- ◆ Several calibration points are provided by default according to the electrical measurement range of the device.

- ◆ The calibration points can be modified. Please do not exceed the range given by the system. Except under special circumstances, modification is not suggested.

2. Perform calibration

-
- ◆ Press the start icon at the right bottom of screen or press the  key to start calibration.
 - ◆ According to the calibrator's prompt, make the standard current/voltage source successively output standard current/voltage of each calibration point to the calibrator. Until the measured value becomes stable, press the  icon on the right side of screen or press the  key to record and continue.
 - ◆ Before final completion of calibration, you can return to the previous operation by using the  icon or  key anytime, until exiting the entire calibration function. This calibration adjustments will not take effect.
 - ◆ If the measured value deviates greatly from the calibration point, it will give a prompt.
 - ◆ After calibration is completed successfully, it will take effect immediately.

3. Restore the factory calibration data.

- ◆ Click  on the right side of screen, to restore the factory data.

4.4.2 Auto tune

Auto tune can optimize controller parameters which have reduced after long-term use, so as to improve the pressure control stability and efficiency.

Caution: Please seal the pressure outlet. Auto tune is necessary only when the pressure calibrator is not performing to specification. Incorrect or unnecessary auto tune may influence the control performance. Please carefully use this function.

4.4.3 Calibration of the supply pressure module

Calibrate the air intake and vent sensors inside the calibrator through an internal pressure control module, to rectify pressure drift caused by long-term operation of internal sensors. During execution, the pressure outlet shall be sealed.

4.4.4 Calibration of the barometric pressure module

The calibrator provides single-point or two-point calibration for the internal barometric pressure module.

- ◆ Single-point calibration

Input the external atmospheric pressure as standard pressure value. Confirm and click the "Save" button to complete calibration.

- ◆ Two-point calibration

- 1) Provide a pressure connection

Connect the calibrator as shown in Figure 4-1.

- 2) Set the calibration points

- The default calibration point is a calibration point used in the last calibration.
- The calibration point can be modified. Please ensure that the input set value of calibration point is within the range of internal barometric pressure module, and the value of point 1 is less than that of point 2.

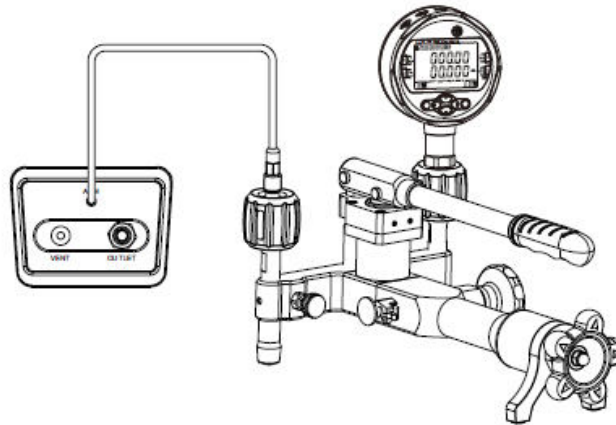

Figure 4- 1 Calibrate an barometric pressure module

3) Perform calibration

- Click ► to perform calibration.
- According to the calibrator's prompt, make the standard instrument output pressure to the calibrator. Until the pressure becomes stable, click ► to perform calibration of the next point.
- If the measured value deviates greatly from the calibration point, it will give a prompt.
- After calibration is completed successfully, new calibration data will take effect immediately, and the calibration date is recorded in the system.

4.4.5 Pressure calibration

1. Connection

- ◆ Calibration of the internal pressure module can select internal pressurization or external pressurization mode.

- ◆ When the internal pressurization mode is selected, please connect the pressure outlet of calibrator to the standard pressure instrument.

- ◆ When the external pressurization mode is selected, please connect the calibrator to the pressure generation of the standard.

- ◆ During calibration of the external pressure module, if the calibrated pressure module is covered by the pressure supply range of internal pressure source, you can select internal or external pressurization. If it is not covered, you can only select external pressurization.

2. Set the calibration points

- ◆ Calibrate the internal pressure module of calibrator through 3 points.

- ◆ Default calibration points are the lower limit, zero point and upper limit of the internal pressure module.

- ◆ Calibrate the external pressure module of calibrator through 2 points.

- ◆ Default calibration points are the lower limit and upper limit of the external pressure module.

- ◆ The calibration points can be modified. Please ensure that the input set values of calibration points are within the range of internal pressure module, and point 1 < point 2 < point 3. Except under special circumstances, modification is not suggested.

3. Perform calibration

- ◆ Click  to perform calibration.

- ◆ Internal pressurization: According to the calibrator's prompt, make the calibrator output pressure to the standard instrument. Until the pressure becomes stable, click the measured value corresponding to this calibration point, and input the pressure reading of standard instrument. After confirmation, click  to perform calibration of the next point.

- ◆ External pressurization:

According to the calibrator's prompt, make the standard instrument output pressure to the calibrator. Until the pressure becomes stable, click  to perform calibration of the next point.

Caution: Please adjust the pressure output of standard instrument to be the same as the set value of calibration point of the calibrator.

- ◆ If the measured value deviates greatly from the calibration point, it will give a prompt.

- ◆ After calibration is completed successfully, new calibration data will take effect immediately, and the calibration date becomes the present system date.

4. Restore factory calibration data

- ◆ Click  on the right side of screen, to restore the factory data.

4.5 Services

4.5.1 System upgrade

The calibrator provides a function of firmware upgrade. The upgrade operation includes two types: Local upgrade via a USB flash drive or remote upgrade

◆ Local upgrade via a USB flash drive

- 1) Copy the upgrade file under the root directory of USB flash drive (ensure that the format of USB flash drive is FAT16 or FAT32).
- 2) After power-on, insert the USB flash drive into the USB-A port on the left side of calibrator.
- 3) Select "Upgrade via USB" on the upgrade interface.
- 4) Click ✓. The calibrator will analyze the upgrade file and display information that it is going to upgrade. After confirmation, the system will start automatic upgrade.
- 5) Wait for several minutes until the upgrade program is finished. The system will automatically display the upgrade result. After confirmation, the system will reboot automatically.

◆ Remote upgrade

- 1) You can click manually to check the latest firmware version or start automatic upgrade.
- 2) Remote upgrade shall ensure that the calibrator can be connected to the external network through LAN Ethernet or Wi-Fi.

4.5.2 Maintenance

Maintenance needs inputting a password. The factory default password is: 123456

◆ Maintenance is used to record the maintenance records, calibration records, and system board upgrade information of the device; and can also execute operation to clear system records.

◆ Maintenance records: Users can add the maintenance personnel, date, content and brief information, which is displayed in the form of list.

◆ Calibration records: Record related information of each calibration, including the calibration

item, calibration time, and detailed calibration data. Users can search and browse it by date and time.

4.5.3 Factory reset

Factory reset requires a password. The factory default password is: 123456. After reset, data clearing is irreversible. Please carefully use this function.

- ◆ Restores the user settings to defaults, and clear snapshot and task files.
- ◆ Inputs the password to enter the factory reset interface. A prompt box will pop up to ask

whether you confirm it. Click "OK" or press the  key to immediately execute the reset operation.

Click "Cancel" or press the  key to cancel operation.

- ◆ Factory reset will not restore system calibration data. If you need to restore the system calibration data, please refer to Section 3.7 "System calibration".

- ◆ After factory reset and reboot, users need to set the date/time. See Section 4.6.1.

4.6 Personalization

Personalization includes date and time, language, and sound settings.

4.6.1 Date and time

Item	Effective value	Description
Time	00:00~23:59	Set the time.
Date	2000-1-1~2099-12-31	Set the date.
Date format	Year-month-day/month-day-year/day-month-year	Set the date format.
Separator	-,/,.	Set the date separator.

Table 4-6 Date and time

4.6.2 Language

The device provides multi-language interfaces. You can select a suitable language interface through this menu.

- ◆ When selected, the language interface will take effect after rebooting the device.

4.6.3 Sound



Item	Effective value	Description
Volume	Volume setting in the form of a progress bar	Set the device volume.
Touch sound	On/off	Enables/disables the sound for the touch screen display.
Prompt sound	On/off	Enables/disables the prompt sound

Over-range warning sound	On/off	Enables/disables the sound for over-range warning
Snapshot sound	On/off	Enables/disables the sound for when a snapshot is taken
Stable sound	On/off	Enables/disables the sound indicating the stability criteria has been meet

Table 4- 7 Sound setup

4.7 Cloud service

◆ Provided through Ethernet or Wi-Fi methods for connection to the ACloud service. Through Additel Link (providing several client modes such as mobile APP and PC), users can monitor the real-time operation status and data of the device anytime anywhere.

◆ After the cloud service is enabled, the top status bar of main interface will display a cloud service state icon  or  , respectively indicating that connection to the cloud service succeeded or failed.

Item	Effective value	Description
Enable	On/off	Enable or disable the cloud service function.

Table 4-8 Setup of cloud service

4.8 Data management

◆ Perform management by function modules. Data management of each function is under the corresponding item for convenience.

- ◆ Function modules that can save data files include: Snapshot, pressure leakage test, etc.
- ◆ Users can export data in the format of CSV through a USB flash drive or PC software.
- ◆ Users can delete data in batches.

4.9 Product information

The product information includes calibrator host information, control board information, electrical

measurement board information, electrical source board information, wireless module information, Profibus module information and HART communicator information.

4.9.1 Host information

- ◆ Includes the model, serial number, host version, system firmware version, system hardware version, power-on times, operation time, etc. Generally, the firmware version refers to host version. When contacting customer service, please provide this information.

4.9.2 Control board information

- ◆ Includes the software version and hardware version of control panel, and the parameters of internal pressure module.

- ◆ The parameters of internal pressure module include: Model, range, number and calibration date.

4.9.3 Electrical measurement board information

- ◆ Includes the software version and hardware version of electrical measurement board, as well as current and voltage measurement parameters.

- ◆ The current and voltage measurement parameters include: Range, accuracy and calibration date.

4.9.4 Electrical source board information

- ◆ Include the software version and hardware version of electrical source board, as well as the current and voltage parameters of electrical output.

- ◆ The current and voltage parameters of electrical source include: Output range, accuracy and

calibration date.

4.9.5 Wireless module information

- ◆ Include the Wi-Fi version, Bluetooth version, etc.

4.9.6 PROFIBUS module information



- ◆ Include the firmware version and hardware version of PROFIBUS module. The PROFIBUS module is used to realize related functions of communication with transmitters.

4.9.7 HART handheld communicator information

Include the DD library version, etc.

5. Documentation

5.1 Quick test

Click the main menu icon  on the main interface, and then select the icon  to enter the quick test function, and the calibrator displays the test type list. The quick test function doesn't require test information to be entered in advance.

5.1.1 Pressure gauge



Select the “pressure gauge” icon  in the test type list to start the quick test of the pressure

gauge.

1. Connection

- ◆ Connect as shown in Figure 3-16 when testing an analog gauge;
- ◆ Connect as shown in Figure 5-1 when testing a digital pressure gauge.



2. Start the test

- ◆ Click the zeroing button  to reset the pressure control module.
- ◆ Click the start button  to select the automatic execution to enter the execution parameter setting interface. Fill in the set point list, the number of cycles, the stroke mode, the number of readings, the reading interval, and the dwell time, and then click the OK button  to start the test. The test data will be manually entered at each point of the test.

◆ Click the next  icon to skip the current test point and enter the next test point for pressure control.

- ◆ Selecting manual execution requires the test point to be entered as the test progresses.
- ◆ To stop this test, click the back button .

3. Save the result

- ◆ Click the save button  to save the test result.
- ◆ The following items will need to be entered: Name and serial number. Then click the check mark in the lower right corner to complete the save the results.
- ◆ To exit without saving press the back button .
- ◆ To redo the test click the reset button .



5.1.2 Pressure transmitter

Select the “pressure transmitter” icon  in the test type list to start the quick.

1. Connection

- ◆ Refer to Section 3.6.2 for connection.



2. Start the test

- ◆ Click the zeroing button  to reset the pressure control module.
- ◆ Click the start button  to select the automatic execution to enter the execution parameter setting interface. Fill in the set point list, the number of cycles, the stroke mode, the number of readings, the reading interval, and the dwell time, and then click the OK button  to start the test.

- ◆ When selecting the manual execution, after the set point is stable, it is required to click the next point button  to collect data and then input the new set point.

- ◆ To stop this test, click the back button .

3. Save the result

- ◆ Click the save button  to save the test result.
- ◆ The following items need to be entered: Name and serial number, click OK button  to save the test results.

- ◆ To exit without saving press the back button .

- ◆ To redo the test click the reset button .





5.1.3 Pressure switch

Select the “pressure switch” icon  in the test type list to start the quick test.

1. Connection

- ◆ Connect the switch as shown in Figure 3-20.



2. Start the test

- ◆ Click the zeroing button  to reset the pressure control module;
- ◆ Click the start button  to select to enter the execution interface;
- ◆ Select the graph display button  and the table display button  to switch between the graph display or table display.

◆ Pressure switch action: When the internal pressure module is used as the standard, it will be automatically run the test. When the external pressure module is used as the standard manual pressure generation is required and the switch data will be recorded.

- ◆ To stop this test, click the back button .

3. Save the result

- ◆ Click the save button  to save the test result.
- ◆ The following items need to be entered: Name and serial number, click OK button  to save the test results.
- ◆ To exit without saving press the back button .

-
- ◆ To redo the test click the reset button  .

5.1.4 Pressure sensor

Select the “pressure sensor” icon  in the test type list to start the quick test.

1. Connection

- ◆ Connect the sensor as shown in Figure 5-2.

2. Start the test

Same as Section 5.1.2 Pressure transmitter.

3. Save the result

Same as Section 5.1.2 Pressure transmitter.

5.1.5 I/P converter

Select the “I/P converter” icon  in the test type list to start the quick test.

1. Connection

- ◆ Connect as shown in Figure 3-21.

2. Start the test

Same as Section 5.1.2 Pressure transmitter.

3. Save the result

Same as Section 5.1.2 Pressure transmitter.

5.1.6 Signal isolator

Select the “signal isolator” icon  in the test type list to start the quick test.

1. Connection

◆ Connect as shown in Figure 5-3.

2. Start the test

Same as Section 5.1.2 Pressure transmitter.



3. Save the result





Same as Section 5.1.2 Pressure transmitter.

5.2 Task

The calibrator provides task functions which automate preset calibration routines, and collect, record, and save test data.

◆ Enter the task interface: Click , and select the task in the menu .

◆ Task list interface: Click  on the right side of the screen to create a new task, click  to delete tasks, and click  to create a new folder.

◆ Test parameter interface: Click  on the right side of the screen to delete the task, click  to edit the task, click  to copy the task, and click  to start the task.

5.2.1 Analog pressure gauge

1. Connection

◆ Connect the calibrator and the analog pressure gauge as shown in Figure 3-14.

◆ It is recommended to connect the reference port (REF) when calibrating a differential pressure device.

2. New task

Select the “analog pressure gauge” icon  in the test type list, and input the information of the pressure gauge.

Item	Effective value	Description
Name	Letter, numeral, symbol	Name of the pressure gauge
Serial number	Letter, numeral, symbol	Serial number of the pressure gauge
Model	Letter, numeral, symbol	Model of the pressure gauge
Pressure type	Gauge pressure, absolute pressure, differential pressure	Pressure type of the pressure gauge
Range	Depends on the pressure gauge	Range and unit of the pressure gauge
Accuracy	0.06%, 0.1%, 0.16%, 0.25%, 0.4%, 0.6%, 1%, 1.6%, 2.5%, 4%, and custom	Precision of the pressure gauge. The numeric input in the custom option is the accuracy of the pressure gauge. For example: For 1.5% accuracy would be input as 1.5 through the numeric keyboard, which has

		a range of (0.001 ~ 100)%
Resolution	Resolution: 0.000001	The resolution of the pressure gauge
Owner	Letter, numeral, symbol	Owner of the pressure gauge
Location	Letter, numeral, symbol	Location position of the pressure gauge
Note	Letter, numeral, symbol	Notes of the pressure gauge

Table 5- 1 Task mode analog pressure gauge information

3. Task setting features

Select the task in the task list to enter the instrument parameter interface, click the start icon to enter the execution information interface, and input the calibration information of the pressure gauge .

Item	Effective value	Description
Set points	The effective value of the set point pressure depends on the pressure range of the gauge; up to 17 calibration points can be set	Set the calibration points for the task, and the calibrator will automatically set the default calibration point based on the range of the calibrated instrument and the number of the calibration points. Any point can be manually selected to be changed to a different point. The set point needs to be within the range of the pressure gauge. Change the number of the calibration points through the arrow key on the right side of the screen or by clicking the number of the calibration points.
Cycle number	1, 2, 3	Select the number of cycles
Stroke	Round trip and one way	Select the calibration task stroke mode
The number of readings	Integer of 1 ~ 6	Input the number of readings to be taken when the calibrator reaches the set point
Reading interval	Integer of (1 ~ 600) seconds	Interval time between two readings

Dwell time	Integer of (1 ~ 600) seconds	The waiting time before readings are taken and the calibrator advances to the next set point.
Input format	Value, the number of scales	<ol style="list-style-type: none"> 1. Value: Digital display of pressure value 2. The number of scales: The pressure value is displayed by counting the number of scales to facilitate the reading and comparison with the value indicated by the analog pressure reading. The calibrated reading = standard value + deviation number of scales X minimum scale division
Tapping	Enable, disable	When enabled the value of the analog pressure gauge needs to be input twice for each calibration point, and then the calibrator will shift to the next calibration point to continue the task.

Table 5- 2 Task setting of analog pressure gauge

4. Task start

Click to start the task process:

-
- ◆ If connecting an external pressure module the correct standard should be selected
 - ◆ Click  on the right to zero the pressure of the pressure module.
 - ◆ Click the task start button at the bottom right, and select the execution mode as automatic execution or manual execution.

1) Automatic execution: The default measurement value is the same as the set point value. The measured value can be manually changed.

2) Manual execution: Every time a set point is reached, the value will need to be entered before advancing to the next set point.

- ◆ The display icon to the right will change the display from graphical to numeric.
- ◆ Standard process of calibration

1) When the calibration point is reached and stable, enter the measurement value for the analog pressure gauge.

2) Click the Enter key on the keyboard or  in the lower right corner of the screen to advance to the next calibration point. At this time, the calibrator will start to control the pressure. The automatic execution mode can be performed without manually advancing if the measurement value is the same as the set point value. ★ When enabling the tapping function, pay attention to the status before/after tapping as prompted by the function screen, and input the indicated value of the gauge before/after tapping.

4) Repeat Step 2&3 until the entire pressure calibration process is completed;

- ◆ After the entire calibration process is completed, it will automatically enter the report interface.

5. Task end

The ADT761A provides calibration task data review, sorting and save functions.

- ◆ After the task is over, the user can choose to see the result of the task through the data view icon or the task data.

- ◆ The user can also click  to abandon the task data and execute the task again.

- ◆ Task data can be stored by clicking  in the save interface and the following information can be entered:

Item	Effective value	Description
Operator	Letter, numeral, symbol	Calibration task operator information
Execution time	2000/01/01-2099/12/31	Calibrator task execution date
Ambient temperature	Numeral	Ambient temperature during task
Temperature unit	K, °C, °F	Unit of ambient temperature during task
Ambient humidity	Numeral	Ambient humidity during task
Save as	As found, as left and both	Save pre-adjustment data or post-adjustment data, or both

Table 5- 3 Task save

- ◆ After saving, return to the task interface.

5.2.2 Digital pressure gauge

1. Connection

- ◆ Connect the calibrator and digital pressure gauge as shown in Figure 5-1;

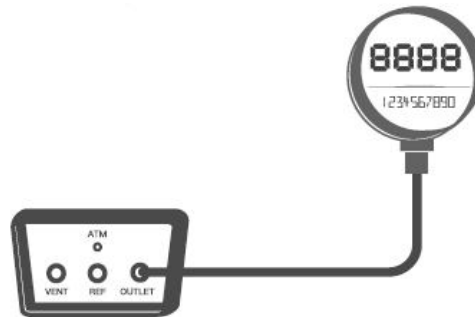



Figure 5- 1 Calibration of digital pressure

- ◆ It is recommended to connect the reference port (REF) when calibrating a differential pressure gauge.

2. New task

Select the “digital pressure gauge” icon  in the test type list. The other contents are the same as those in Section 5.2.1 New Task for Calibration of the analog pressure gauge. The accuracy setting for calibration of the digital pressure gauge is slightly different from the analog pressure gauge. The effective values of the accuracy for calibration of the digital pressure gauge are 0.025%, 0.05%,

0.1%, 0.16%, 0.25%, 0.4%, 1 %, 1.6%, 2.5%, 4%, and custom.

3. For the contents of task setting, refer to Section 5.2.1 Task setting for calibration of the analog pressure gauge. There are no settings for tapping and input format for calibration of the digital pressure gauge.

4. For the contents of task start, refer to Section 5.2.1 task start for calibration of the analog pressure gauge.

5. For the contents of task end, refer to Section 5.2.1 task end for calibration of the analog pressure gauge.

5.2.3 Calibrate a pressure transmitter

During the task, the calibrator can automatically measure and record the current or voltage value output from the transmitter.

1. Connection

Refer to Section 3.6.2 for connection.

2. New task

Select the “pressure transmitter” icon  in the test type list, and input the information of the calibrated pressure transmitter in turn:

Item	Effective value	Description
Name	Letter, numeral, symbol	Name of the pressure transmitter
Serial number	Letter, numeral, symbol	Serial number of the pressure transmitter

Model	Letter, numeral, symbol	Model of the pressure transmitter
Pressure type	Gauge pressure, absolute pressure, differential pressure	Pressure type of the pressure transmitter
Input	Depends on the pressure transmitter	Pressure range of the pressure transmitter
Output	Analog signal: (4~20)mA, (0~10)mA, (0~20)mA, (1~5)V, (0~5)V, (0~10)V, and custom	Electric signal output range of current/voltage and pressure transmitters
	HART device: Process variable (PV), percentage, process variable analog output (PVAO), and loop current	Electrical signal output type of HART device
	PROFIBUS PA	PROFIBUS output
Range	Depends on the pressure transmitter	Range and unit of the pressure transmitter
Accuracy	0.05%, 0.1%, 0.2%, 0.5%, 1%, 1.5%, 2%, 2.5%, and custom	Accuracy of the pressure transmitter

Owner	Letter, numeral, symbol	Owner of the pressure transmitter
Location	Letter, numeral, symbol	Location of the pressure transmitter
Notes	Letter, numeral, symbol	Notes of the pressure transmitter

Table 5- 4 Task mode pressure transmitter information

3. Task setting

For the contents, refer to Section 5.2.1 Task settings for calibration of the analog pressure gauge.

4. Task start

◆ For the contents, refer to Section 5.2.1 Task start for calibration of the analog pressure gauge.

◆ The transmitter output is an analog signal and may need loop power supplied either internally or externally.

◆ For HART devices click  on the right to configure HART.

◆ For PROFIBUS PA click  on the right to configure PA.

◆ In the calibration interface, click the task start button at the bottom right. In the pressure transmitter task mode, the user can choose the automatic execution mode or the manual execution mode.

◆ After the entire calibration process is completed, it will automatically enter the report interface.

5. Task end

For the contents, refer to Section 5.2.1 Task end for calibration of the analog pressure gauge.

5.2.4 Pressure transducer

1. Connection

- ◆ Connect the calibrator and the pressure sensor (providing excitation current or excitation voltage) as shown in Figure 5-2. If excitation current doesn't need to be supplied then there is not a need to connect the electrical outlet.
- ◆ It is recommended to connect the reference port (REF) when calibrating differential pressure devices.

2. New task

Select the “pressure transducer” icon  in the test type list, and input the information of the pressure transducer.

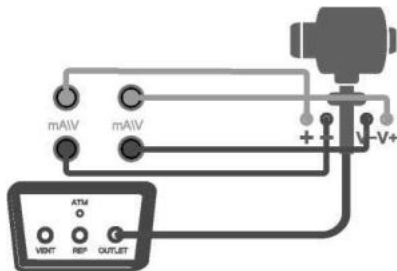

Figure 5- 2 Calibration of the pressure sensor

Item	Effective value	Description
------	-----------------	-------------

Name	Letter, numeral, symbol	Name of the pressure sensor
Serial number	Letter, numeral, symbol	Serial number of the pressure sensor
Model	Letter, numeral, symbol	Model of the pressure sensor
Pressure type	Gauge pressure, absolute pressure, differential pressure	Pressure type of the pressure sensor
Input	Depends on the pressure sensor	Pressure range of the pressure sensor
Output	(4~20)mA, (0~20)mA, (1~5)V, (0~10)V, (0~100)mV, (0~200)mV, and custom	Electric signal output range of current/voltage and pressure sensors
Accuracy	0.01%, 0.02%, 0.05%, 0.1%, 0.2%, 0.5%, 1%, 1.5%, 2.5%, 4%, and custom	Precision of the pressure sensor.
Transferfunction	Linear, square root, square	Type of transfer function of the pressure sensor
Owner	Letter, numeral, symbol	Owner of the pressure sensor
Location	Letter, numeral, symbol	Location of the pressure sensor
Notes	Letter, numeral, symbol	Notes of the pressure sensor

Table 5- 5 Task mode pressure transducer information

3. Task setting

For the contents, refer to Section 5.2.1 Task setting for calibration of the analog pressure gauge.

4. Task start

- ◆ For some contents, refer to Section 5.2.1 Task start for calibration of the analog pressure gauge. Note that it does not require a manual input of the indicated value in this test.
- ◆ If connecting an external pressure module, it needs to be selected
- ◆ If loop power is required, please set it before starting

5. For the contents of task end, refer to Section 5.2.1 task end for calibration of the analog pressure gauge.

5.2.4 Pressure switch

1. Connection

- ◆ Connect the calibrator and the pressure switch as shown in Figure 3-20;

2. New task

Select the “pressure switch” icon  in the test type list, and input the information of the pressure switch.

Item	Effective value	Description
Name	Letter, numeral, symbol	Name of the pressure sensor

Serial number	Letter, numeral, symbol	Serial number of the pressure sensor
Model	Letter, numeral, symbol	Model of the pressure switch
Pressure type	Gauge pressure, absolute pressure, differential pressure	Pressure type of the pressure switch, check the support conditions according to the calibrator model
Input	Depends on the pressure switch	Pressure range of the pressure switch
Accuracy	0.5%, 1%, 1.5%, 2%, 2.5%, 4%, and custom	Precision of the pressure switch. The numeral input in the custom option is the precision level of the pressure switch
Set point	Depends on the range of the pressure switch	Operating point of the pressure switch
Action type	Normally closed, normally open	Action type of the pressure switch
Switch type	Mechanical switch, NPN switch, PNP switch	Type of the pressure switch
Dead band	Depends on the range of the pressure switch	Dead band range of the pressure switch
Owner	Letter, numeral, symbol	Owner of the pressure switch
Location	Letter, numeral, symbol	Location of the pressure switch
Notes	Letter, numeral, symbol	Notes of the pressure switch

Table 5- 6 Task mode pressure switch information



3. Task setting

Select the task in the task list to enter the instrument parameter interface, click the start icon to enter the execution information interface.

- ◆ Input the number of cycles.

4. Task start

Click  on the right side of the screen to zero the calibrator.

- ◆ Click the execution button to start the task.
- ◆ The upper left of the screen indicates the reading value of the current control pressure, and the upper right indicates the switch state.
- ◆ During the test, it can click the graph display button  and the table display button  to switch to graph display or table display.
- ◆ The switch action status and action value will be recorded and displayed in the table interface
- ◆ When the internal pressure module is selected as the standard, the pressure switch test method is based on slew rate in the control settings and the rate is gradually attenuated following the change of state for the switch.
- ◆ When using an external pressure module, the control must be done manually.
- ◆ Click the stop icon at the bottom right of the screen to end the task.

5. Task end

For the contents, refer to Section 5.2.1 Task end for calibration of the analog pressure gauge.

5.2.6 I/P converter

1. Connection

- ◆ Connect the calibrator and the I/P converter as shown in Figure 3-21;
- ◆ Never apply pressure out of the range of the calibrator.
- ◆ If the loop power supply is enabled (with maximum load of 50mA), check the load capacity.

2. New task

Select the “I/P converter” icon  in the test type list, and input the information of the I/P converter.

Item	Effective value	Description
Name	Letter, numeral, symbol	Name of the I/P converter
Serial number	Letter, numeral, symbol	Serial number of the I/P converter
Model	Letter, numeral, symbol	Model of the I/P converter
Pressure type	Gauge pressure, absolute pressure, differential pressure	Pressure type of the I/P converter
Input	(4~20)mA, (4~12)mA, (12~20)mA, and custom	Input current range of the I/p converter
Output	Depends on the I/P converter	Output pressure range of the I/p converter
Accuracy	0.025%, 0.05%, 0.1%,	Precision of the I/P converter.

	0.16%, 0.25%, 0.4%, 1%, 1.6%, 2.5%, 4%, and custom	
Transfer function	Linear, square root	Type of transfer function of the I/P converter
Owner	Letter, numeral, symbol	Owner of the I/P converter
Location	Letter, numeral, symbol	Location of the I/P converter
Notes	Letter, numeral, symbol	Notes of the I/P converter

Table 5- 7 Task mode I/P converter information

3. Task setting

For the contents, refer to Section 5.2.1 Task setting for calibration of the analog pressure gauge.

4. Task start

- ◆ For some contents, refer to Section 5.2.1 Task start for calibration of the analog pressure gauge.
- ◆ Enable or disable loop power as required
- ◆ If the external pressure module is connected, the internal module or the external module will be the selected for the calibrated output standard;
- ◆ If the internal pressure range is selected, the pressure output range of the calibrated converter shall not exceed the internal range of the calibrator;
- ◆ If the external pressure module is selected, the pressure output range of the calibrated converter shall not exceed the range of selected external pressure module.

5. Task end

For the contents, refer to Section 5.2.1 Task end for calibration of the analog pressure gauge.

5.2.7 Signal isolator

1. Connection

- ◆ Connect the calibrator and the signal isolator as shown in Figure 5-3;

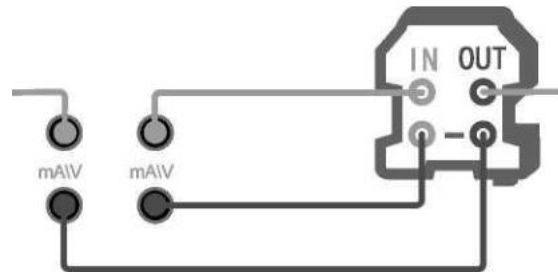



Figure 5- 3 Calibration of the signal isolator

2. New task

Select the “signal isolator” icon  in the test type list, and input the information of the calibrated signal isolator.

Item	Effective value	Description
Name	Letter, numeral, symbol	Name of the signal isolator
Serial number	Letter, numeral, symbol	Serial number of the signal isolator
Model	Letter, numeral, symbol	Model of the signal isolator
Accuracy	0.05%, 0.1%, 0.2%, 0.5%, 1%, 1.5%, 2%, 2.5%, and custom	Precision of the signal isolator.
Input	(0~25)mA, (0~16)V	Input current range or voltage range of the signal isolator
Output	(-50~50)mA, (-30~30)V, (-300~300)mV	Output current range or voltage range of the signal isolator
Transfer function	Linear, square root	Type of transfer function of the signal isolator
Owner	Letter, numeral, symbol	Owner of the signal isolator
Location	Letter, numeral, symbol	Location of the signal isolator
Notes	Letter, numeral, symbol	Notes of the signal isolator

Table 5- 8 Task mode signal isolator information

3. Task setting

For the contents, refer to Section 5.2.1 Task setting for calibration of the analog pressure gauge.

4. Task start

- ◆ For some contents, refer to Section 5.2.1 Task start for calibration of the analog pressure gauge. Note that it does not require manual input of the indicated value in this test.
- ◆ Enable or disable loop power as required for the input.
- ◆ For Enable or disable loop power as required for the output.

5. Task end

For the contents, refer to Section 5.2.1 Task end for calibration of the analog pressure gauge.

5.2.8 Contact pressure gauge

1. Connection

Connect the calibrator and the contact pressure gauge as shown in Figure 5-4:

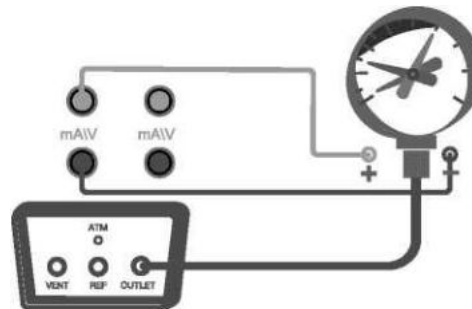



Figure 5- 4 Calibration of the contact pressure gauge

2. New task

Select the “contact pressure gauge” icon  in the test type list, and input the information of the calibrated contact pressure gauge.

Item	Effective value	Description
Name	Letter, numeral, symbol	Name of the contact pressure gauge
Serial number	Letter, numeral, symbol	Serial number of the contact pressure gauge
Model	Letter, numeral, symbol	Model of the contact pressure gauge
Pressure type	Gauge pressure, absolute pressure, differential pressure	Pressure type of the pressure sensor
Range	Depends on the pressure gauge	Range and unit of the contact pressure gauge
Accuracy	0.06%, 0.1%, 0.16%, 0.25%, 0.4%, 0.6%, 1%, 1.6%, 2.5%, 4%, and custom	Precision of the contact pressure gauge.
Division Value	Minimum resolution: 0.000001	Minimum resolution of the contact pressure gauge
Owner	Letter, numeral, symbol	Owner of the contact pressure gauge
Location	Letter, numeral, symbol	Location of the contact pressure gauge
Notes	Letter, numeral, symbol	Notes of the contact pressure gauge

Table 5- 9 Task mode contact pressure gauge information

3. Task setting

Select the task in the task list to enter the instrument parameter interface, click the start icon to enter the execution information interface, and input the calibration process information of the contact pressure gauge in turn:

Item	Effective value	Description
Set point list	Effective value of the set point pressure depends on calibrated gauge Pressure range; up to 17 calibration points can be set	Set the calibration point for the task, and the calibrator will automatically set the default calibration points based on the range of the calibrated instrument and the number of the calibration points. The value and number of points can be adjusted as necessary.
Cycle number	1, 2, 3	Select the number of calibration process cycles
Stroke	Round trip and one way	Select the calibration task stroke mode
The number of readings	Integer of 1 ~ 6	Input the number of readings to be taken when the calibrator reaches the set point
Reading interval	Integer of (1 ~ 600) seconds	Interval time between collection of two readings
Dwell time	Integer of (1 ~ 600) seconds	Waiting time from a stable set point the collection of all readings

Input format	Value, the number of scales	1. Value: Digital display of pressure value 2. The number of scales: The pressure value is displayed by counting the number of scales to facilitate the reading and comparison with the value indicated by the pressure gauge. The calibrated reading = standard value + deviation number of scales X minimum scale division
Tapping	Enable, disable	When enabled, the value of the pressure gauge needs to be input twice for each calibration point, and then the calibrator will advance to the next calibration point to continue the task
Electric contact test	Open, close	Select whether to test the electric contacts
Electric contact test point control pressure rate	1~10000Pa/s	Input the control pressure rate for electric contact test

Table 5- 10 Task setting of contact pressure gauge

4. Task start

- ◆ For some contents, refer to Section 5.2.1 Task start for calibration of the analog pressure gauge.
- ◆ When starting the electric contact test in the task setting, it will test the on/off value, and during the test, it will switch to the data collection interface to collect the switch on and off values.

◆ Enable or disable loop power as required for the input.

For Enable or disable loop power as required for the output.5. Task end

For the contents, refer to Section 5.2.1 Task end for calibration of the analog pressure gauge.

5.2.9 Valve opening gauge

1. Connection

◆ Connect the calibrator and the valve opening gauge as shown in Figure 5-5.

2. New task

Select the “valve opening gauge” icon  in the test type list, and input the information of the calibrated valve opening gauge.

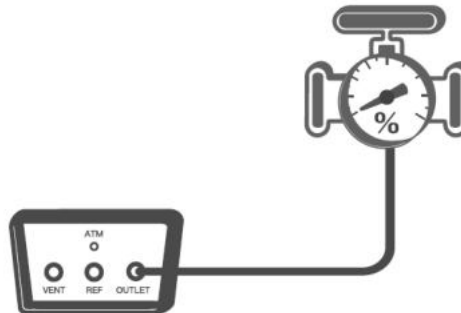

Figure 5- 5 Calibration of the valve opening gauge

Item	Effective value	Description
Name	Letter, numeral, symbol	Name of the valve opening gauge
Serial number	Letter, numeral, symbol	Serial number of the valve opening gauge
Model	Letter, numeral, symbol	Model of the valve opening gauge
Pressure type	Gauge pressure, absolute pressure, differential pressure	Pressure type of the valve opening gauge
Input	Pressure: depending on the valve opening gauge	Pressure range of the valve opening gauge
	Electrical output: depending on the valve opening gauge	Current range of the valve opening gauge
Output	0%~100%, -360°~360°	Output range of the valve opening gauge
Range	Depends on the pressure gauge	Range and unit of the valve opening gauge
Accuracy	0.06%, 0.1%, 0.16%, 0.25%, 0.4%, 0.6%, 1%, 1.6%, 2.5%, 4%, and custom	Precision of the valve opening gauge.
Transfer function	Linear, square root, square	Type of transfer function of the valve opening gauge

Owner	Letter, numeral, symbol	Owner of the valve opening gauge
Location	Letter, numeral, symbol	Location of the valve opening gauge
Notes	Letter, numeral, symbol	Notes of the valve opening gauge.

Table 5- 11 Task mode valve opening gauge information

3. Task setting

For the contents, refer to Section 5.2.1 Task setting for calibration of the analog pressure gauge.

4. Task start



For some contents, refer to Section 5.2.1 Task start for calibration of the analog pressure gauge.

- ◆ Set loop power settings as necessary.

5. Task end

For the contents, refer to Section 5.2.1 Task end for calibration of the analog pressure gauge.

5.3 Quick test (for barometric (BP) version)

Click the main menu icon  on the main interface, and then select the icon  on the main menu that pops up to enter the quick test function, and the calibrator displays the test type list.

5.3.1 Digital barometer

1. Prepare



- ◆ Select “digital barometer” in the test type list to start the quick test of digital barometer.

2. Connection

- ◆ When testing the general digital barometer, connect to the calibrator as shown in Figure 5-6.

- ◆ When testing the VAISALA digital barometer, it needs to connect the calibrator and the communication interface as shown in Figure 5-7.

3. Start the test

- ◆ Click the start button  to select the automatic execution to enter the execution parameter setting interface. Fill in the set point list, the number of cycles, the stroke mode, the number of readings, the reading interval, and the dwell time, and then click the OK button  to start the test. In case of the general digital barometer, the readings need to be manually input during the test. For the VAISALA digital barometer, the calibrator can automatically obtain the readings through communication port.
- ◆ Click the next button  to skip the current set point and enter the next set point for pressure control.
- ◆ Selecting the manual execution requires manual input for each reading.

◆ To stop this test, press the back button .

4. Save the result

◆ Click the save button  to save the test result.

◆ The following are required fields: Name and serial number, click OK button  to complete the save.

◆ Click the back button  to return to the test type list interface without saving.

◆ Click the reset button  to rerun the test.

5.3.2 Mercury barometer



1. Prepare







◆ Select “mercury barometer” in the test type list to enter to the quick test process of the mercury barometer.

2. Connection



◆ Connect to the calibrator as shown in Figure 5-8.

3. Start the test



◆ Click the start button  to select the automatic execution to enter the execution parameter setting interface. Fill in the set point list, the number of cycles, the stroke mode, the number of readings, the reading interval, and the dwell time, and then click the OK button  to start the test. During the test readings will need to be manually input.

- ◆ When selecting the next button  , it will skip the current set point and advance to the next set point.
 - ◆ Selecting the manual execution requires readings and set points to be manually input.
 - ◆ To stop this test, press the back button .
4. Save the result
- ◆ Click the save button  to save the test results.
 - ◆ Required fields are as follows: Name and serial number, then click OK button  to save.
 - ◆ Click the back button  to return to the test type list interface to exit without saving the results.
 - ◆ To restart the test, click the reset button  to return to the ready to start test interface.





5.3.3 Aneroid barometer

1. Prepare
 - ◆ Select “aneroid barometer” in the test type list to enter to the quick test process of the aneroid barometer.
2. Connection
 - ◆ Connect to the calibrator as shown in Figure 5-9.
3. Start the test
 - ◆ Click the start button  to select the automatic execution to enter the execution parameter setting interface. Fill in the set point list, the number of cycles, the stroke mode, the number of readings, the reading interval, and the dwell time, and then click the OK button  to start

the test. During the test, manually input the reading and correction value of the aneroid barometer.

- ◆ Click the next point button  to skip the current set point and advance to the next set point.
- ◆ Selecting the manual execution requires manual input of each set point and readings.
- ◆ To stop the test, press the back button .

4. Save the result

- ◆ Click the save button  to save the test results.
- ◆ Required fields are as follows: Name and serial number, then click OK button  to save.
- ◆ Click the back button  to return to the test type list interface to exit without saving the results.
- ◆ To restart the test, click the reset button  to return to the ready to start test interface.

5.3.4 Barometric altimeter

1. Prepare

- ◆ Select “barometric altimeter” in the test type list to enter to the quick test process of the barometric altimeter.



2. Connection

- ◆ Connect to the calibrator as shown in Figure 5-10.





3. Start the test

- ◆ Click the start button  to select the automatic execution to enter the execution parameter setting interface. Fill in the set point list, the number of cycles, the stroke mode, the number

of readings, the reading interval, and the dwell time, and then click the OK button  to start the test. During the test manually input the reading of the barometric altimeter.

- ◆ Click the next point button  to skip the current set point and advance to the next set point.
- ◆ Select manual execution requires to input a new set point after inputting the reading every time;
- ◆ To stop the test, press the back button .

4. Save the result

- ◆ Click the save button  to save the test results.
- ◆ Required fields are as follows: Name and serial number, then click OK button  to save.
- ◆ Click the back button  to return to the test type list interface to exit without saving the results.
- ◆ To restart the test, click the reset button  to return to the ready to start test interface.

5.3.5 Pressure transmitter

Same as Section 5.1.2 Pressure transmitter.

5.3.6 Pressure switch

Same as Section 5.1.3 Pressure switch.

5.4 Task (for barometric (BP) version)

5.4.1 Digital barometer

1. Connection

- ◆ If calibrating the general digital barometer, connect the calibrator and the general digital barometer as shown in Figure 5-6.
- ◆ If calibrating the VAISALA digital barometer, connect as shown in Figure 5-7.

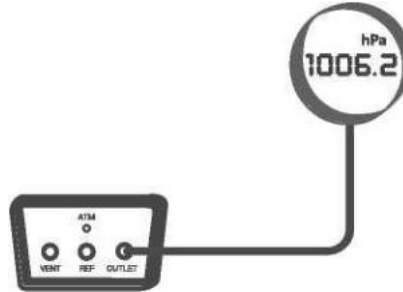

Figure 5- 6 Calibration of the general digital barometer

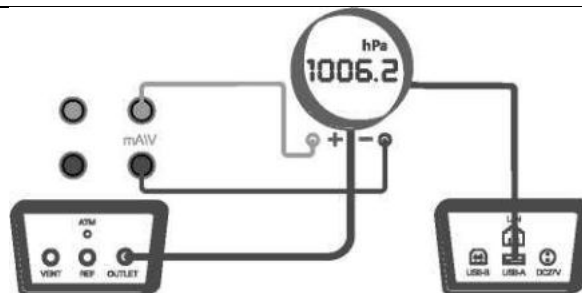

Figure 5- 7 Calibration of the VAISALA digital barometer

2. New task

Select the “digital barometer” in the test type list, and input the information of the barometer.

Item	Effective value	Description
Name	Letter, numeral, symbol	Name of the digital barometer
Serial number	Letter, numeral, symbol	Serial number of digital barometer
Model	Letter, numeral, symbol	Model of the digital barometer
Calibration range	Depends on the barometer	The input upper and lower limits can't be equal.
Allowable error	0.01~100%	Allowable error of digital barometer
Rounding of reading	1, 0.1, 0.01	Rounding format of the reading
Owner	Letter, numeral, symbol	Owner of the barometer

Location	Letter, numeral, symbol	Location of the barometer
Notes	Letter, numeral, symbol	Notes of the barometer

Table 5- 12 Task mode digital barometer

3. Task setting

For the contents, refer to Section 5.2.1 Task setting for calibration of the analog pressure gauge.

- ◆ When calibrating the VAISALA digital barometer, it needs to configure the serial communication parameters.

4. Task start

For the contents, refer to Section 5.2.1 Task start for calibration of the analog pressure gauge.

5. Task end

For the contents, refer to Section 5.2.1 Task end for calibration of the analog pressure gauge.

5.4.2 Calibration of the mercury barometer

1. Connection

- ◆ Connect the calibrator and the calibrated mercury barometer as shown in Figure 5-8.

2. New task

Select the “mercury barometer” in the test type list, and input the information of the barometer.

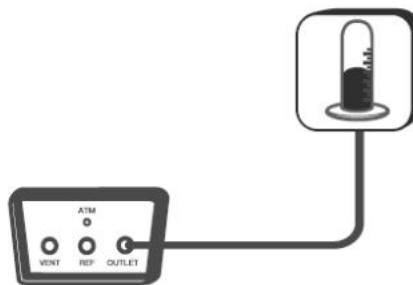

Figure 5- 8 Calibration of the mercury barometer

Item	Effective value	Description
Name	Letter, numeral, symbol	Name of the general digital barometer
Serial number	Letter, numeral, symbol	Serial number of the general digital barometer
Model	Letter, numeral, symbol	Model of the general digital barometer
Calibration range	Depends on the pressure gauge	The input upper and lower limits can't be equal. Pay attention to the range of the calibrated device, or otherwise the tested device may be damaged.
Rounding of reading	1, 0.1, 0.01	Rounding format of the reading
Allowable error	Depends on the barometer	Set the absolute allowable error
Temperature coefficient	Depends on the barometer	Used to calculate the impact of the ambient temperature of the barometer on the value indicated by the tested gauge in the calibration task process
Owner	Letter, numeral, symbol	Owner of the mercury barometer
Location	Letter, numeral, symbol	Location of the mercury barometer
Notes	Letter, numeral, symbol	Notes of the mercury barometer

Table 5- 13 Task mode mercury barometer

3. Task setting

For the contents, refer to Section 5.2.1 Task setting for calibration of the analog pressure gauge.

4. Task start

For the contents, refer to Section 5.2.1 Task start for calibration of the analog pressure gauge.

5. Task end

For the contents, refer to Section 5.2.1 Task end for calibration of the analog pressure gauge.

5.4.3 Aneroid barometer

1. Connection

◆ Connect the calibrator and the mercury barometer as shown in Figure 5-9:

2. New task

Select the “aneroid barometer” in the test type list. The other contents are the same as those in Section 5.2.1 New Task for Calibration of the analog pressure gauge.

3. Task setting

For the contents, refer to Section 5.2.1 Task setting for calibration of the analog pressure gauge.

4. Task start

For the contents, refer to Section 5.2.1 Task start for calibration of the analog pressure gauge.

5. Task end

For the contents, refer to Section 5.2.1 Task end for calibration of the analog pressure gauge.

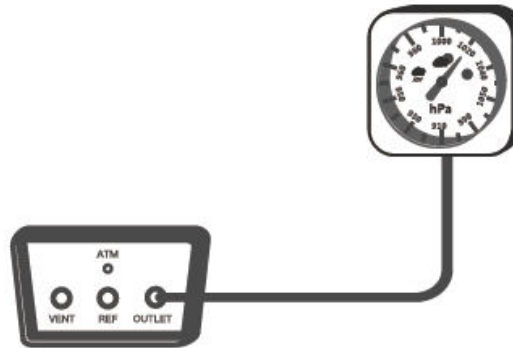

Figure 5- 9 Calibration of the aneroid barometer

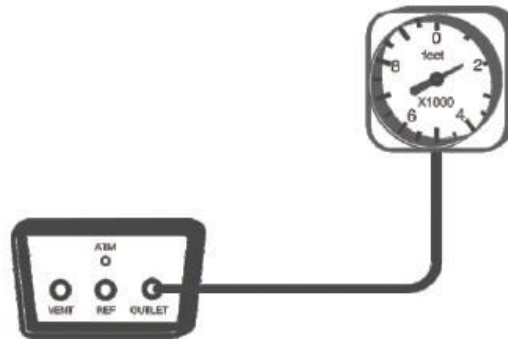

Figure 5- 10 Calibration of the barometric altimeter

5.4.4 Barometric altimeter

1. Connection

◆ Connect the calibrator and the barometric altimeter as shown in Figure 5-10.

2. New task

Select the “barometric altimeter” in the test type list, and input the information of the barometric altimeter

Item	Effective value	Description
Name	Letter, numeral, symbol	Name of the barometric altimeter
Serial number	Letter, numeral, symbol	Serial number of the barometric altimeter
Model	Letter, numeral, symbol	Model of the barometric altimeter
Calibration range	Depends on the barometric altimeter	The input upper and lower limits can't be equal. Pay attention to the range of the calibrated device, or otherwise the tested device may be damaged, and the units of calibrated range shall only be meter and feet in height
Rounding of reading	1, 0.1, 0.01	Rounding format of the reading
Allowable error	Depends on the pressure gauge	Set the absolute allowable error of the segment
Owner	Letter, numeral, symbol	Owner of the barometric altimeter
Location	Letter, numeral, symbol	Location of the barometric altimeter

Notes	Letter, numeral, symbol	Notes of the barometric altimeter
-------	-------------------------	-----------------------------------

Table 5- 14 Task mode barometric altimeter

3. Task setting

For the contents, refer to Section 5.2.1 Task setting for calibration of the analog pressure gauge.

4. Task start

For the contents, refer to Section 5.2.1 Task start for calibration of the analog pressure gauge.

5. Task end

For the contents, refer to Section 5.2.1 Task end for calibration of the analog pressure gauge.

5.4.5 Pressure transmitter

Same as Section 5.2.3, except that no pressure type selection is provided when creating a new task.

5.4.6 Pressure switch

Same as Section 5.2.5, except that no pressure type selection is provided when creating a new task.

6. Application

6.1 Unit conversion

- ◆ Click the menu in the upper right corner on the main interface to select the application, and then enter the pressure unit converter.
- ◆ Supports conversion between multiple pressure units.

6.2 Pressure leak test

There are two pressurization ways of pressure leak detection:

a) Calibrator pressurization: Select the internal high or low pressure range, and the calibrator will automatically run the test.

b) External pressurization: Select an external pressure module and use external pressure generation to run the leak test.

1. Setup

- ◆ Select the application in the function menu to enter the pressure leak test.
 - ◆ Click the upper area on the interface to select the range: Select the internal module range or the external pressure module.
- 1) If the external pressure module is selected, there is no need to set the pressure target value;.
- ◆ Select the pressure unit: If the selected unit is not supported by the selected module, it will automatically revert to the last setting.

◆ Set point

- 1) There is no need to set this parameter when selecting the external pressure module.
- 2) It shall not exceed the selected measuring range.
- 3) Use this setting as the leak detection pressure point.
- 4) The pressure control set point value during the test.

◆ Set the waiting time

1) Select the internal range: After the control pressure is stable during the execution (the real-time pressure value turns green) and it switches to measure mode and starts the countdown of the waiting time.

- 2) Select the external pressure module: Waiting time will be counted down after execution begins.
- 3) Enter the test time after the waiting time ends.

◆ Set the test time

1) Select the internal range: After entering the test time, start the countdown, implement the test, and stop the test after the time reaches 0.

2) Select the external pressure module: Same as the internal range.

◆ Pressure type



1) Some devices can switch the gauge pressure and differential pressure.

2. Execution

◆ Internal range

1) Control the pressure with the set pressure value as the target value.

2) After stabilization (the real-time pressure value turns green), stop the control and switch to the measurement mode, and count down the waiting time.

-
- 3) Record the pressure at the end of the waiting time as the starting pressure.
 - 4) Start the test, count down the test time, and start to calculate the real-time leakage amount at the same time. The real-time leakage amount = the starting pressure - the real-time pressure.
 - 5) Record the pressure at the end of the test time as the end pressure, and then vent the calibrator to the atmosphere.
 - 6) The final leakage amount = the starting pressure - the ending pressure.
 - 7) During 4), press  on the right side of the screen to stop this test, and press  and  to switch between the forms of table and graph.
 - 8) After the test, click the save icon on the right side of the screen to execute the save operation for this test.

◆ External pressure module

- 1) Connect the pressure module.
- 2) Apply pressure to desired pressure for the leak test.
- 3) Press the  key or the start icon on the right side of the screen to start execution and start the countdown of the waiting time. Record the real-time pressure at the end of the waiting time as the starting pressure.
- 4) Start the test, count down the test time, and start to calculate the real-time leakage amount at the same time. The real-time leakage amount = the starting pressure - the real-time pressure.
- 5) Record the pressure at the end of the test time as the end pressure.
- 6) The entire leak detection process ends, and the final leakage amount = the starting pressure - the ending pressure.

-
- ◆ The entire process is shown in stages in the leak detection curve diagram at the bottom of the screen.

7. HART Communication

The calibrator provides full HART communicator function. Using the original HART DD file, the calibrator can be used to complete almost all HART pressure device maintenance and debugging, including parameter modification, fault diagnosis, daily maintenance and calibration, etc. Because the operation of communicator on the HART device depends on the DD file, the operation methods of different HART devices are quite different, so refer to the operation instructions of the HART device before using the communicator function.





Note: During communication with a HART device, the calibrator acts as a master station all the time. To avoid damaging the control system, you must separate the HART device from the control system before connecting the calibrator to HART device.

7.1 HART connection and search

See 3.3.3 HART Communication connection and search.

7.2 HART communicator operation

- ◆ Read the parameters in HART which may be modified. The root directory options are 1-4. Depending on the HART device, the parameters that have been modified but not written in HART are highlighted in yellow in the list. Click  to finish the operation of writing into the HART device.

-
- ◆ After entering, click  on the right side of the screen to view the explanation information of some parameters.
 - ◆ After entering the parameter editing interface, click the control center  icon in the status bar to copy the indications of the internal pressure module, A and B indications of the external pressure modules, HART indications, and the electrical measurement indications.
 - ◆ Click  and  on the right side of the screen to view the communication status and the device status respectively. After entering, the open circle on the right side of the list indicates that there is no abnormality or it indicates that the item is abnormal
 - ◆ Click T_{ref} on the right side of the screen to return to the main interface of the device. To return to the HART communicator again, click  in the upper right corner of the screen.

8. System maintenance

8.1 Device information view

- ◆ On the system setting interface, select the product information. For details, see Section 4.9 Product information.
- ◆ When the external pressure module is online, it can also view its related information.

8.2 Diagnostic information

In case of any abnormalities of the calibrator, there will be a corresponding prompt message, and the message notification center icon on the top status bar will turn red and flash for alarm. By selecting the alarm you can see the information in the diagnostic center.

8.3 Check the sealing performance of the calibrator

The sealing performance of the calibrator has a crucial impact on its control speed and control pressure stability. Slow pressurization speed, long stabilization time of the control output, and too much fluctuation of the output pressure in the process may all be caused by poor sealing. The method of checking the sealing performance of the calibrator is as follows:

- ◆ Use a plug (standard fitting) to block the outlet (OUTLET).
- ◆ Operate the calibrator to output the maximum pressure. After reaching the pressure, switch to measure mode and wait for 2 minutes.
- ◆ The output pressure drop speed of the ADT761A-LLP or ADT761A-D calibrator shall be less

than 0.002 $\kappa\text{Pa}/\text{seconds}$. and the ADT761A-500 and ADT761A-1K calibrator shall be less than 0.02 $\kappa\text{Pa}/\text{second}$.

◆ It can also use the leak test application of the calibrator (see Section 6.2).

8.4 Suction filter replacement



Figure 8- 1 Disassembly of the suction filter

The maintenance of the suction filter is as shown in Figure 8-1:

1. With the battery module removed, remove the two screws.
2. Remove the cover.
3. Clean or replace the filter.
4. Retighten the cover with screws.
5. Maintenance cycle is 3~6 months/time dependent on use.

Make sure that it is carried out after pressure inside the calibrator is completely drained and the device is shut down.

8.5 Replacement of the filter at the air pressure output interface and the O-ring

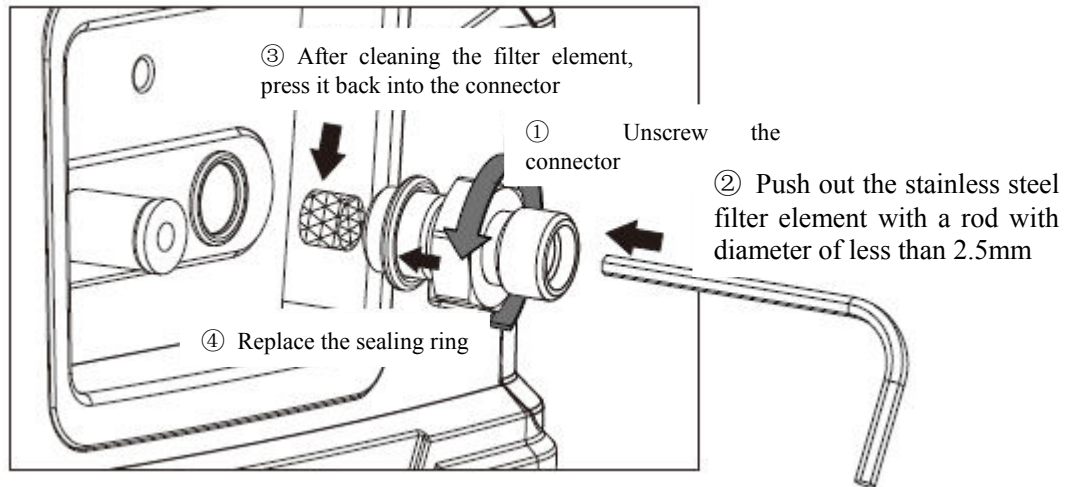

Figure 8- 2 Disassembly of air pressure/high-precision/barometric (BP) version pressure connector

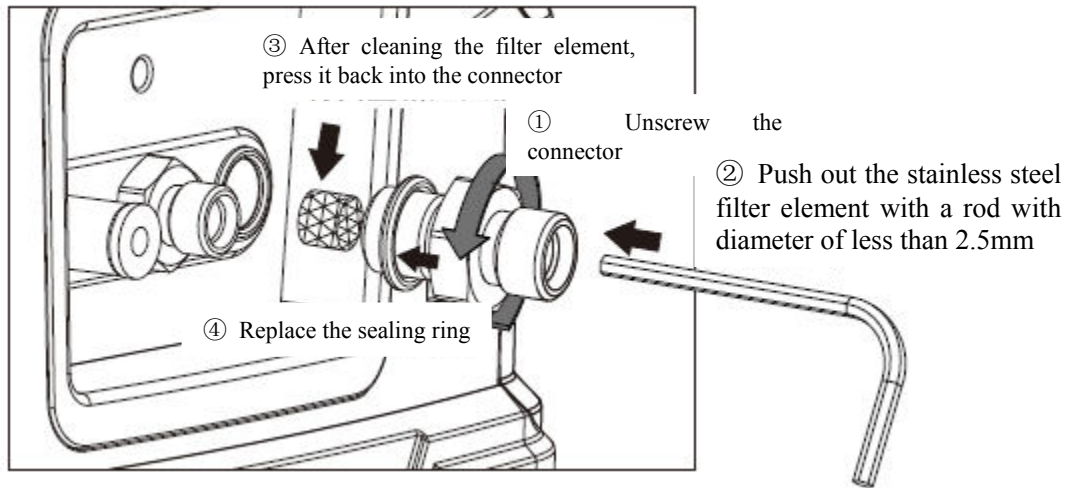

Figure 8- 3 Disassembly of differential pressure connector

Maintenance of the pressure connector position as shown in Figure 8-2 and Figure 8-3 above.

1. Unscrew the pressure connector counterclockwise.
2. Remove the filter, replace or clean the stainless steel filter element, and then press it into the groove below the adapter.
3. Replace the O-ring.
4. Retighten the pressure connector to the pressure interface.
5. Maintenance cycle is 3~6 months/time depending on use.

Make sure that it is carried out after pressure inside the calibrator is completely drained and the device is shut down.

8.6 Air filter replacement

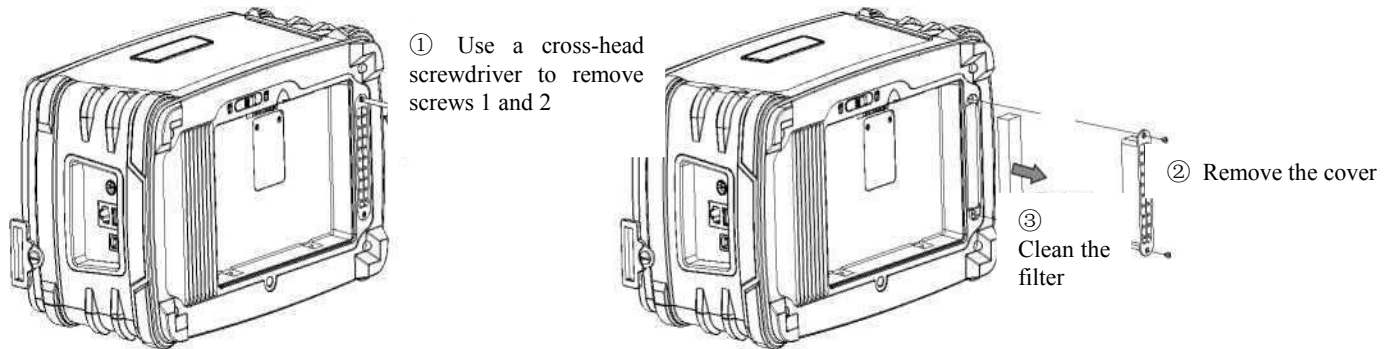

Figure 8- 4 Disassembly and assembly of the air filter

Maintenance of the air filter position is as shown in Figure 8-4:

1. On the right side of the battery jar of the calibrator, remove the two screws.
2. Remove the cover.
3. Clean the air filter.
4. Retighten the cover with screws.
5. Maintenance cycle is 3~6 months/time depending on use.

Make sure that it is carried out after pressure inside the calibrator is completely drained and the device is shut down.