

# SIEMENS

## SITRANS F

### Electromagnetic flowmeters SITRANS FM MAG 5000/6000 IP67

#### Operating Instructions

<u>Introduction</u>	<b>1</b>
<u>Safety notes</u>	<b>2</b>
<u>Description</u>	<b>3</b>
<u>Installing/Mounting</u>	<b>4</b>
<u>Connecting</u>	<b>5</b>
<u>Commissioning</u>	<b>6</b>
<u>Operating</u>	<b>7</b>
<u>Service and maintenance</u>	<b>8</b>
<u>Diagnostics and Troubleshooting</u>	<b>9</b>
<u>Technical data</u>	<b>10</b>
<u>Spare parts/Accessories</u>	<b>A</b>
<u>Menu diagrams</u>	<b>B</b>
<u>Factory settings</u>	<b>C</b>
<u>Product documentation and support</u>	<b>D</b>

7ME6910 (SITRANS MAG 5000)  
7ME6920 (SITRANS MAG 6000)

## Legal information

### Warning notice system

This manual contains notices you have to observe in order to ensure your personal safety, as well as to prevent damage to property. The notices referring to your personal safety are highlighted in the manual by a safety alert symbol, notices referring only to property damage have no safety alert symbol. These notices shown below are graded according to the degree of danger.

<b>⚠ DANGER</b>
indicates that death or severe personal injury <b>will</b> result if proper precautions are not taken.

<b>⚠ WARNING</b>
indicates that death or severe personal injury <b>may</b> result if proper precautions are not taken.

<b>⚠ CAUTION</b>
indicates that minor personal injury can result if proper precautions are not taken.

<b>NOTICE</b>
indicates that property damage can result if proper precautions are not taken.

If more than one degree of danger is present, the warning notice representing the highest degree of danger will be used. A notice warning of injury to persons with a safety alert symbol may also include a warning relating to property damage.

### Qualified Personnel

The product/system described in this documentation may be operated only by **personnel qualified** for the specific task in accordance with the relevant documentation, in particular its warning notices and safety instructions. Qualified personnel are those who, based on their training and experience, are capable of identifying risks and avoiding potential hazards when working with these products/systems.

### Proper use of Siemens products

Note the following:

<b>⚠ WARNING</b>
Siemens products may only be used for the applications described in the catalog and in the relevant technical documentation. If products and components from other manufacturers are used, these must be recommended or approved by Siemens. Proper transport, storage, installation, assembly, commissioning, operation and maintenance are required to ensure that the products operate safely and without any problems. The permissible ambient conditions must be complied with. The information in the relevant documentation must be observed.

### Trademarks

All names identified by ® are registered trademarks of Siemens AG. The remaining trademarks in this publication may be trademarks whose use by third parties for their own purposes could violate the rights of the owner.

### Disclaimer of Liability

We have reviewed the contents of this publication to ensure consistency with the hardware and software described. Since variance cannot be precluded entirely, we cannot guarantee full consistency. However, the information in this publication is reviewed regularly and any necessary corrections are included in subsequent editions.

# Table of contents

<b>1</b>	<b>Introduction</b> .....	<b>7</b>
1.1	Purpose of this documentation.....	7
1.2	Document history .....	7
1.3	Checking the consignment.....	8
1.4	Items supplied .....	8
1.5	Security information .....	8
1.6	Transportation and storage.....	9
1.7	Notes on warranty .....	9
<b>2</b>	<b>Safety notes</b> .....	<b>11</b>
2.1	Laws and directives.....	11
2.2	Conformity with European directives.....	12
2.3	Installation in hazardous location .....	12
<b>3</b>	<b>Description</b> .....	<b>15</b>
3.1	System components.....	15
3.2	Operating principle .....	15
3.3	Applications .....	15
3.4	Features .....	16
3.5	MAG 5000/MAG 6000 versions .....	16
3.6	Nameplate layout .....	17
<b>4</b>	<b>Installing/Mounting</b> .....	<b>21</b>
4.1	Introduction .....	21
4.2	Installation conditions.....	22
4.3	MAG 5000/6000 compact .....	24
4.4	Remote installation.....	26
4.4.1	At sensor .....	26
4.5	MAG 5000/6000 CT .....	30
4.5.1	Installing hardware key .....	30
4.5.2	Sealing of MAG 5000/6000 CT .....	31
4.5.2.1	Verification sealing .....	31
4.5.2.2	User sealing .....	32
4.5.3	Installation conditions.....	32
4.5.3.1	MI-001 .....	32
4.5.3.2	PTB K7.2.....	33
4.6	Turning transmitter/keypad .....	33

<b>5</b>	<b>Connecting .....</b>	<b>37</b>
5.1	Electrical connection .....	38
5.2	Electrical connection PTB K7.2.....	40
5.3	Connection of add-on modules .....	40
<b>6</b>	<b>Commissioning .....</b>	<b>41</b>
6.1	MAG 5000/6000 Blind .....	41
6.2	Local user interface .....	42
6.3	Menu structure .....	43
6.4	Changing password .....	44
6.5	Changing basic settings .....	44
6.6	Changing operator menu setup.....	47
6.7	Changing language .....	48
<b>7</b>	<b>Operating .....</b>	<b>51</b>
7.1	Output settings .....	51
7.2	External input .....	53
7.3	Sensor characteristics .....	53
7.4	Reset mode .....	53
7.5	Service mode .....	55
7.6	MAG 5000 CT and MAG 6000 CT settings.....	55
7.7	MAG 6000 SV .....	56
<b>8</b>	<b>Service and maintenance .....</b>	<b>57</b>
8.1	Transmitter check list .....	57
8.2	Technical support.....	58
8.3	Return procedure .....	59
8.4	Recalibration .....	60
<b>9</b>	<b>Diagnostics and Troubleshooting .....</b>	<b>61</b>
9.1	Diagnostics.....	61
9.2	List of error numbers .....	63
<b>10</b>	<b>Technical data .....</b>	<b>67</b>
10.1	Technical specifications .....	67
10.2	Accuracy .....	70
10.3	Output characteristics .....	72
10.4	Cable data.....	75
10.5	Cable requirements.....	76

---

<b>A</b>	<b>Spare parts/Accessories.....</b>	<b>77</b>
A.1	Ordering of spare parts .....	77
A.2	Spare parts.....	77
A.3	Sun shield .....	78
<b>B</b>	<b>Menu diagrams.....</b>	<b>79</b>
B.1	Transmitter menu overview.....	79
B.2	Basic settings .....	80
B.3	Current output .....	83
B.4	Digital output - pulse .....	83
B.5	Digital output - frequency .....	84
B.6	Digital output / Relay output - Error level .....	84
B.7	Digital output / Relay output - Error number.....	84
B.8	Digital output / Relay output - Direction/limit .....	85
B.9	Relay output - Cleaning.....	85
B.10	Digital output / Relay output - Batch.....	85
B.11	External input .....	87
B.12	Sensor characteristics.....	88
B.13	Reset mode.....	89
B.14	Reset mode - MAG 6000 SV.....	90
B.15	Service mode .....	91
B.16	Operator menu setup .....	92
B.17	Product identity .....	93
B.18	Add-on communication module.....	94
B.19	Change password .....	94
<b>C</b>	<b>Factory settings .....</b>	<b>95</b>
C.1	Transmitter factory settings.....	95
C.2	50 Hz Dimension dependent Qmax .....	97
C.3	60 Hz Dimension dependent Qmax .....	98
C.4	50 Hz Dimension dependent volume/pulse and batch.....	100
C.5	60 Hz Dimension dependent volume/pulse and batch.....	101
<b>D</b>	<b>Product documentation and support.....</b>	<b>103</b>
D.1	Product documentation .....	103
D.2	Technical support.....	104
	<b>Index.....</b>	<b>105</b>



# Introduction

## 1.1 Purpose of this documentation

These instructions contain all information required to commission and use the device. Read the instructions carefully prior to installation and commissioning. In order to use the device correctly, first review its principle of operation.

The instructions are aimed at persons mechanically installing the device, connecting it electronically, configuring the parameters and commissioning it, as well as service and maintenance engineers.

## 1.2 Document history

This document describes:

- SITRANS F MAG 5000 and MAG 6000 transmitters (standard version).
- Optional versions:
  - MAG 5000 Blind and MAG 6000 Blind
  - MAG 5000 CT and MAG 6000 CT
  - MAG 6000 SV

### Documentation history

The following table shows major changes in the documentation compared to the previous edition.

Edition	Remarks	FW version
12/2019	<ul style="list-style-type: none"> <li>• BBL42 as default unit</li> <li>• Improved operation without SENSORPROM</li> <li>• Responsibility transfer to Siemens AG</li> </ul>	4.09
12/2013	<ul style="list-style-type: none"> <li>• Customer defined unit</li> <li>• Velocity value with unit</li> <li>• Operational without SENSORPROM</li> <li>• Signal suitability</li> </ul>	4.07
01/2012		4.04
01/2010	First edition	

### 1.3 Checking the consignment

1. Check the packaging and the delivered items for visible damages.
2. Report any claims for damages immediately to the shipping company.
3. Retain damaged parts for clarification.
4. Check the scope of delivery by comparing your order to the shipping documents for correctness and completeness.

<b>⚠ WARNING</b>
<b>Using a damaged or incomplete device</b>
Risk of explosion in hazardous areas.
<ul style="list-style-type: none"><li>• Do not use damaged or incomplete devices.</li></ul>

### 1.4 Items supplied

- SITRANS F M MAG 5000/6000 transmitter
- Siemens Process Instrumentation documentation disk containing certificates, and manuals
- Safety note
- Calibration report

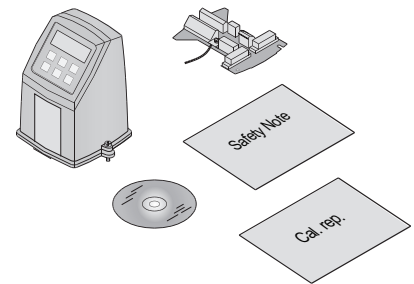

### 1.5 Security information

Siemens provides products and solutions with industrial security functions that support the secure operation of plants, systems, machines and networks.

In order to protect plants, systems, machines and networks against cyber threats, it is necessary to implement – and continuously maintain – a holistic, state-of-the-art industrial security concept. Siemens’ products and solutions constitute one element of such a concept.

Customers are responsible for preventing unauthorized access to their plants, systems, machines and networks. Such systems, machines and components should only be connected to an enterprise network or the internet if and to the extent such a connection is necessary and only when appropriate security measures (e.g. firewalls and/or network segmentation) are in place.

For additional information on industrial security measures that may be implemented, please visit <https://www.siemens.com/industrialsecurity>.

Siemens’ products and solutions undergo continuous development to make them more secure. Siemens strongly recommends that product updates are applied as soon as they are available and that the latest product versions are used. Use of product versions that are no longer



supported, and failure to apply the latest updates may increase customer's exposure to cyber threats.

To stay informed about product updates, subscribe to the Siemens Industrial Security RSS Feed under <https://www.siemens.com/industrialsecurity>.

## 1.6 Transportation and storage

To guarantee sufficient protection during transport and storage, observe the following:

- Keep the original packaging for subsequent transportation.
- Devices/replacement parts should be returned in their original packaging.
- If the original packaging is no longer available, ensure that all shipments are properly packaged to provide sufficient protection during transport. Siemens cannot assume liability for any costs associated with transportation damages.

<b>NOTICE</b>
<b>Insufficient protection during storage</b>
The packaging only provides limited protection against moisture and infiltration.
<ul style="list-style-type: none"><li>• Provide additional packaging as necessary.</li></ul>



Special conditions for storage and transportation of the device are listed in Technical data (Page 67).

## 1.7 Notes on warranty

The contents of this manual shall not become part of or modify any prior or existing agreement, commitment or legal relationship. The sales contract contains all obligations on the part of Siemens as well as the complete and solely applicable warranty conditions. Any statements regarding device versions described in the manual do not create new warranties or modify the existing warranty.

The content reflects the technical status at the time of publishing. Siemens reserves the right to make technical changes in the course of further development.





## CAUTION

**Correct, reliable operation of the product requires proper transport, storage, positioning and assembly as well as careful operation and maintenance.**

Only qualified personnel should install or operate this instrument.

### Note

Alterations to the product, including opening or improper modifications of the product are not permitted.

If this requirement is not observed, the CE mark and the manufacturer's warranty will expire.

## 2.1 Laws and directives

### General requirements

Installation of the equipment must comply with national regulations. For example EN 60079-14 for the European Community.

### Instrument safety standards

The device has been tested at the factory, based on the safety requirements. In order to maintain this condition over the expected life of the device the requirements described in these Operating Instructions must be observed.

### Environmental conditions according to IEC 61010-1 (2010)

- Indoor use
- Altitude up to 2000m
- Maximum relative humidity 80% for temperatures up to 31°C (88°F) decreasing linearly up to 50% relative humidity from 40°C (104°F)
- Main supply voltage fluctuations up to  $\pm 10\%$  of the nominal voltage (see Technical specifications (Page 67))
- Overvoltage category II
- Pollution degree 2

### Environmental conditions according MID (Directive 2014/32/EU)

- Environment class: E2 (electromagnetic), M1 (mechanical)
- Climatic class: -25°C - +55°C, condensing, closed

## 2.2 Conformity with European directives

The CE marking on the device symbolizes the conformity with the following European directives:

Electromagnetic compatibility EMC 2014/30/EU	Directive of the European Parliament and of the Council on the harmonisation of the laws of the Member States relating to electromagnetic compatibility
Low voltage directive LVD 2014/35/EU	Directive of the European Parliament and of the Council on the harmonisation of the laws of the Member States relating to the making available on the market of electrical equipment designed for use within certain voltage limits
Atmosphère explosible ATEX 2014/34/EU	Directive of the European Parliament and the Council on the harmonisation of the laws of the Member States relating to equipment and protective systems intended for use in potentially explosive atmospheres
CT: Measuring instruments directive MID 2014/32/EU	Directive of the European Parliament and the Council on the harmonisation of the laws of the Member States relating to the making available on the market of measuring instruments

The applicable directives can be found in the EU declaration of conformity of the specific device.

## 2.3 Installation in hazardous location

 <b>WARNING</b>
<b>Conditions for safe use</b>
Equipment used in hazardous areas must be Ex-approved and marked accordingly. It is required that the special conditions for safe use provided in the manual and in the Ex certificate are followed!

### Ex approvals

CSA Class I, Division 2, Groups A, B, C and D. Code T5 for an ambient temperature of +60 °C.  
FM Class I, Division 2, Groups A, B, C and D and Class I, Zone 2, Group IIC indoor/outdoor  
Type IP67 hazardous (classified) locations.

## Process temperature specifications for Ex use

Temperature class	Ambient temperature [°C]		
	-40 to +40	-40 to +50	-40 to +60
T2	180	-	-
T3	165	140	-
T4	100	100	80
T5	65	65	65
T6	50	50	50

## EX requirements

It is required that:

- Electrical connections are in accordance with Elex V (VO in explosion hazardous areas) and EN60079-14 (Installing Electrical Systems in Explosion Hazardous Areas).
- The protective cover over the power supply is properly installed. For intrinsically safe circuits the connection area can be opened.
- Appropriate cable connectors are used for the output circuits: intrinsically safe: blue, non-intrinsically safe: black.
- Sensor and transmitter are connected to the potential equalization. For intrinsically safe output circuits potential equalization must be maintained along the entire connection path.
- Sensor insulation thickness is max. 100mm (only insulated sensors).
- EN60079-31 is considered for installation in areas with combustible dust.
- When protective earth (PE) is connected, no potential difference between the protective earth (PE) and the potential equalization (PA) can exist, even during a fault condition.

*2.3 Installation in hazardous location*

## Description

### 3.1 System components

A SITRANS F M MAG 5000/6000 flowmeter system includes:

- Transmitter (type SITRANS F M MAG 5000/6000)
- Sensor (types: SITRANS F MAG 1100/1100F/3100/3100 P/5100 W)
- Communication module (optional) (types: HART, PROFIBUS PA/DP, MODBUS RTU RS 485, Foundation Fieldbus H1, Devicenet)
- SENSORPROM memory unit

#### Communication solutions

The SITRANS F USM II range of add on modules, presently including HART, Foundation Fieldbus, MODBUS RTU RS 485, PROFIBUS PA / DP and Devicenet, are all applicable with the SITRANS F M MAG 6000 transmitter.

### 3.2 Operating principle

The transmitters are microprocessor-based with a built-in alphanumeric display in several languages. The flow measuring principle is based on Faraday's law of electromagnetic induction. Magnet coils mounted diametrically on the measuring pipe generate a pulsed electromagnetic field. The liquid flowing through this electromagnetic field induces a voltage.

The transmitters evaluate the signals from the associated electromagnetic sensors, convert the signals into appropriate standard signals such as 4 to 20 mA, and also fulfil the task of a power supply unit providing the magnet coils with a constant current.

The transmitter consists of a number of function blocks which convert the sensor voltage into flow readings.

### 3.3 Applications

The pulsed DC-powered magnetic flowmeters are suitable for measuring the flow of almost all electrically conductive liquids, pastes, and slurries with max. 40% solids.

The main applications can be found in the following sectors:

- Water and waste water
- Chemical and pharmaceutical industries
- Food & beverage industry
- Mining and cements industries
- Pulp and paper industry

- Steel industry
- Power generation; utility and chilled water industry

 <b>WARNING</b>
<b>This is a Class A product</b>
In a domestic environment this product may cause radio interference in which case the user may be required to take adequate measures.

## 3.4 Features

### Power supply

2 different types of power supply are available. A 12 to 24 V AC/DC and a 115 to 230 V AC switch mode type.

Coil current module generates a pulsating magnetizing current that drives the coils in the sensor. The current is permanently monitored and corrected. Errors or cable faults are registered by the self-monitoring circuit.

Input circuit amplifies the flow-proportional signal from the electrodes. The input impedance is extremely high:  $>10^{14} \Omega$  which allows flow measurements on fluids with conductivities as low as  $5 \mu\text{S/cm}$ . Measuring errors due to cable capacitance are eliminated due to active cable screening.

Digital signal processor converts the analog flow signal to a digital signal and suppresses electrode noise through a digital filter. Inaccuracies in the transmitter as a result of long-term drift and temperature drift are monitored and continuously compensated for via the self-monitoring circuit. The analog to digital conversion takes place in an ultra low noise ASIC with 23 bit signal resolution. This has eliminated the need for range switching. The dynamic range of the transmitter is therefore unsurpassed with a turn down ratio of minimum 3000:1.

### Dialog module

The display unit consists of a 3-line display and a 6-key keypad. The display shows a flow rate or a totalizer value as a primary reading.

### Output module

The output module converts flow data to analog, digital and relay outputs. The outputs are galvanically isolated and can be individually set to suit a particular application.

## 3.5 MAG 5000/MAG 6000 versions

The transmitters are designed in various versions and offer high performance and easy installation, commissioning and maintenance.



### Standard version



The standard version is an IP67 version for compact or remote installation. Its robust design ensures a long lifetime if installed outdoors.

### Blind version



This version carries all the normal MAG 5000/6000 features, except those associated with the display and keypad.

Both current and digital outputs are available.

Factory setting of current output in unit is switched off when delivered.

### CT version



The MAG 5000/6000 CT version is a custody transfer approved transmitter.

It is approved according to:

- Cold water approval:
  - MI-001 (Tested according to OIML R 49)
- Other media than water:
  - PTB K7.2

The above approval specifications apply at the time of publication. For the latest approval updates, see: <http://support.automation.siemens.com/WW/view/en/10806951/134200>

### SV version (MAG 6000 only)



This version is identical to the standard MAG 6000 transmitters except for the following additional functions:

- Zero point adjustment
- Adjustable excitation frequency up to 44 Hz

## 3.6 Nameplate layout

### Inspection

1. Check for mechanical damage due to possible improper handling during shipment. All claims for damage are to be made promptly to the shipper.
2. Make sure the scope of delivery, and the information on the type plate corresponds to the ordering information.

3.6 Nameplate layout

Identification

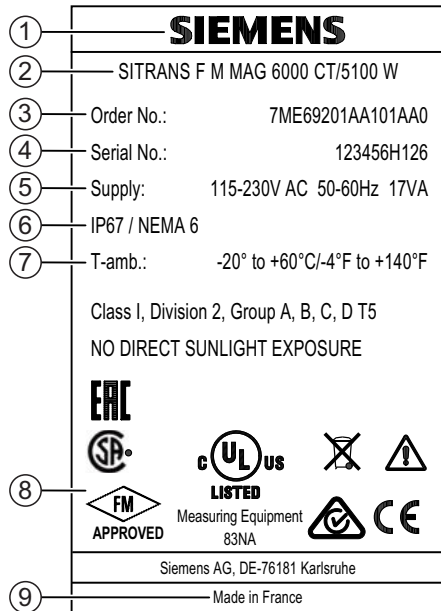

- ① Manufacturer
- ② Product name
- ③ Order number
- ④ Serial number
- ⑤ Power supply
- ⑥ Degree of protection
- ⑦ Ambient temperature
- ⑧ Conformity with country-specific directives
- ⑨ Place of manufacture

Figure 3-1 MAG 6000 transmitter nameplate example

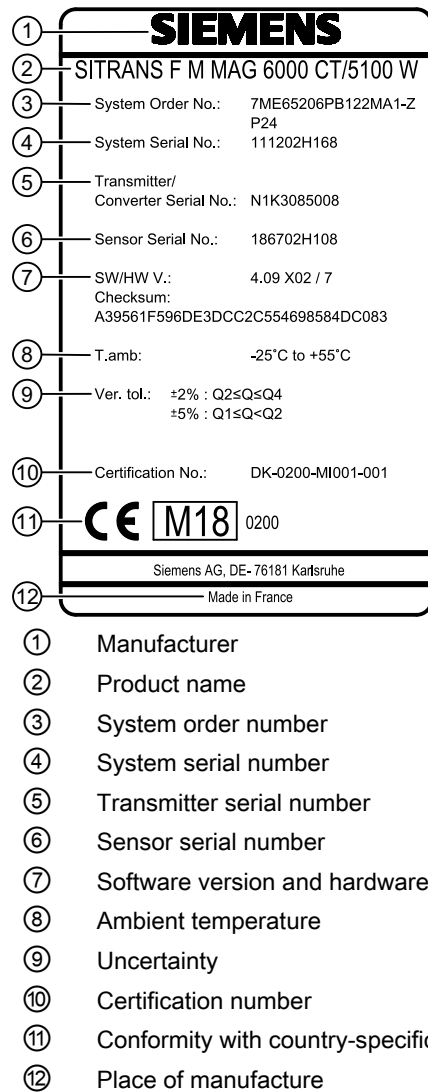

Figure 3-2 MAG 6000 CT system nameplate example

3.6 Nameplate layout

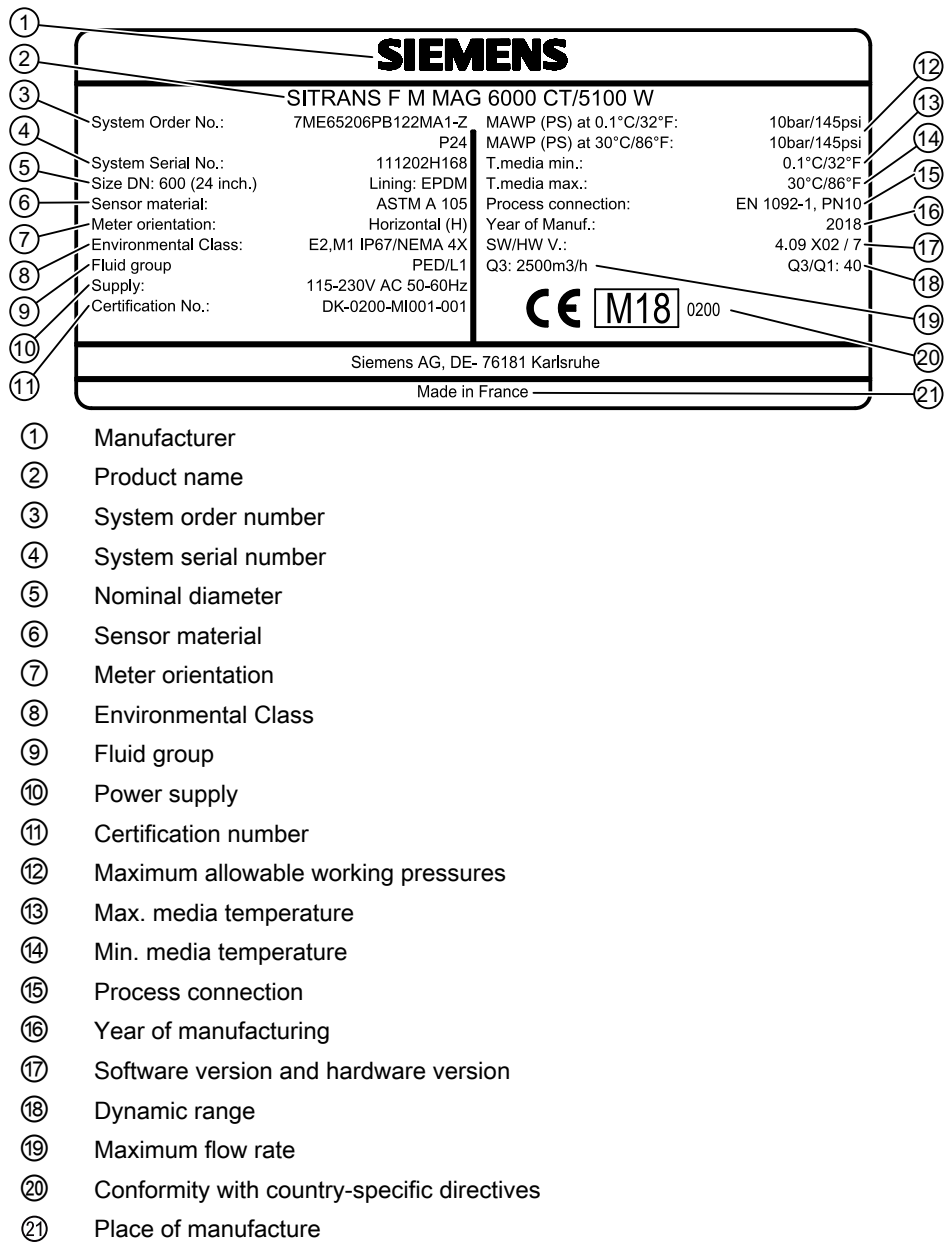

Figure 3-3 MAG 5000/6000 CT system sensor nameplate example

**Note**

**The matched paired transmitter and sensor shall be mounted together**

At installation, please check that the system nameplates of transmitter and sensor have the same system serial number.

# Installing/Mounting

## 4.1 Introduction

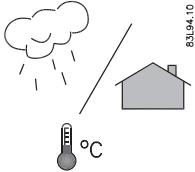

- SITRANS F flowmeters are suitable for indoor and outdoor installations.

<b>! WARNING</b>
<b>Installation in hazardous location</b>
Special requirements apply to the location and interconnection of sensor and transmitter. See Installation in hazardous location (Page 12)

This chapter describes how to install the flowmeter in the compact version as well as in the remote version.

The transmitter is delivered ready for mounting on the sensor. The transmitter is delivered with a compression plate ready for mounting on the sensor. No further assembling is necessary.

The transmitter can be installed either compact on the sensor or remote.

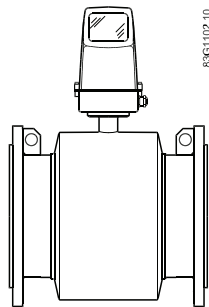

Figure 4-1 Compact installation

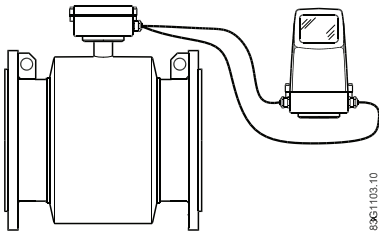

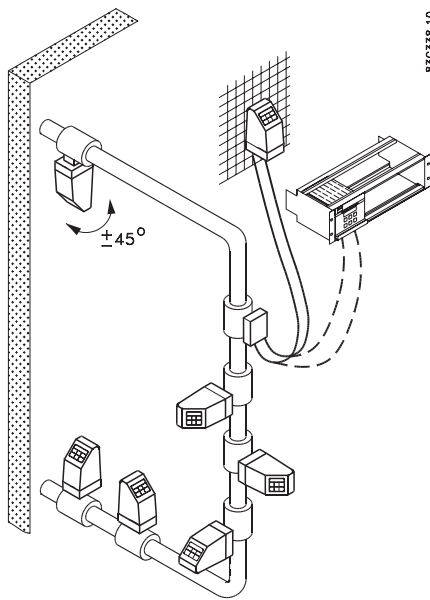

Figure 4-2 Remote installation

 <b>CAUTION</b>
See Cable requirements (Page 76) before installing transmitter

## 4.2 Installation conditions

Reading and operating the flowmeter is possible under almost any installation conditions because the display can be oriented in relation to the sensor. To ensure optimum flow measurement, attention should be paid to the following:



### Vibrations

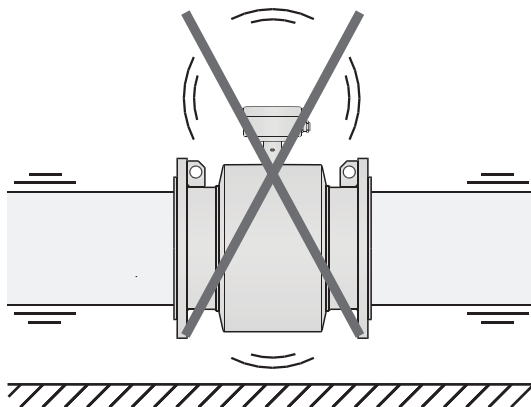
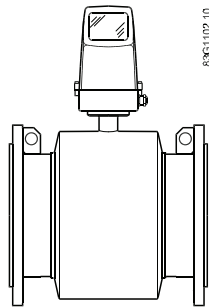

Figure 4-3 Avoid strong vibrations

### Compact installation



Medium temperature must be in accordance with the graphs showing max. ambient temperature as a function of medium temperature.

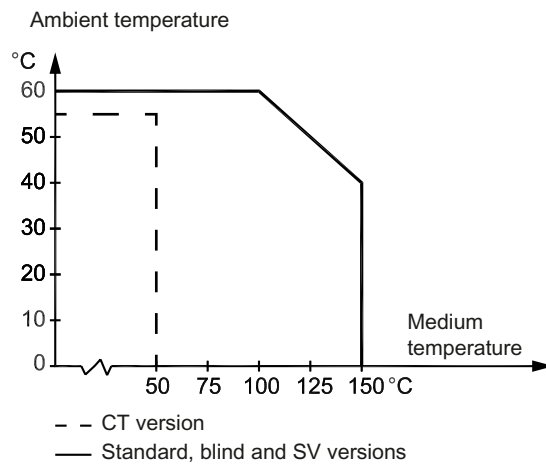
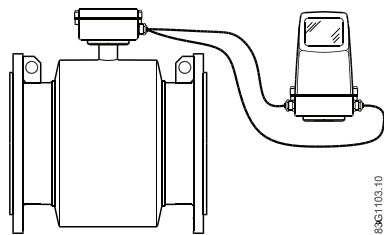

Figure 4-4 Medium and ambient temperatures

### Remote installation



Cable length and type (as described in Cable requirements (Page 76)) must be used.  
For installation conditions for sensors, see relevant sensor Operating Instructions.

## 4.3 MAG 5000/6000 compact

### Install MAG 5000 / MAG 6000 compact version

1. Remove and discard terminal box lid of sensor.

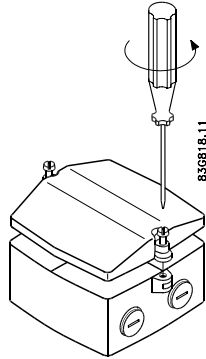

2. Ensure SENSORPROM® memory unit is installed.
3. Fit M20 or ½" NPT cable glands for supply and output cables.
4. Unplug the two black plug assemblies for coil and electrode cables in terminal box.
5. Connect earth wire from connection board to bottom of terminal box.
6. Connect 2-pin connector and 3-pin connector as shown to their corresponding terminal numbers on connection board as shown in Electrical connection (Page 38).

#### Note

System will not register flow if black plugs are not connected to connection board.

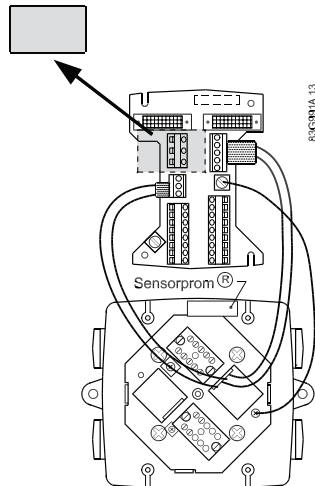

7. Fit supply and output cables through cable glands and connect to connection plate as shown in Electrical connection (Page 38).



8. Mount connection plate in terminal box.

**Note**

Check that your connection board lines up with SENSORPROM® unit, if not, move SENSORPROM® unit to the other side of terminal box.

SENSORPROM® memory unit connections will be established automatically when connection plate is mounted in terminal box.

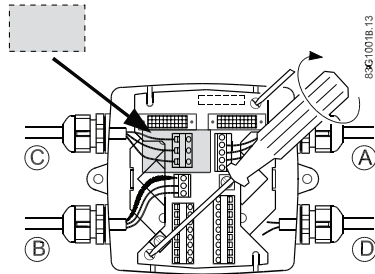

9. Tighten cable glands to obtain optimum sealing.
10. Mount transmitter on terminal box. Recommended torque value: 2.5 Nm.

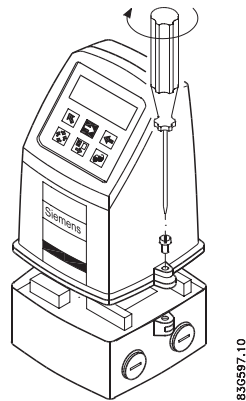

11. Transmitter is ready to be powered up.

**NOTICE**

Exposing transmitter to direct sunlight may increase operating temperature above its specified limit, and decrease display visibility.

A sunshield is available as accessory.

## 4.4 Remote installation

### 4.4.1 At sensor

1. Remove terminal box lid.

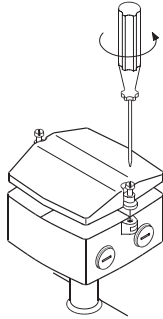

2. Mount the two terminal blocks as shown and insert electrode cable plug ① (terminals 85 and 86) and coil cable plug ② (terminals 82, 0 and 83).

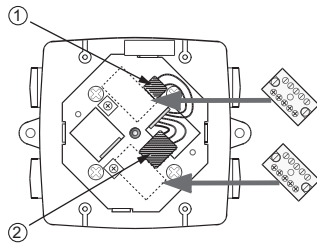

3. Remove SENSORPROM (to be mounted in transmitter terminal box). Ensure that the serial no. on the SENSORPROM label is identical to the sensor serial no.

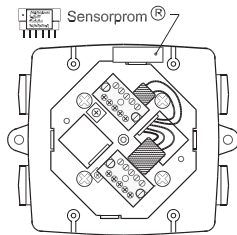

4. Connect electrode cable ③ and coil cable ④ in the corresponding terminals on the terminal blocks.

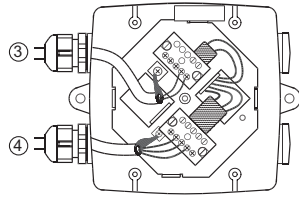

5. Remount terminal box lid.

---

**Note**

**Tightening torque**

Tighten the bolts with 0.5 Nm.

---

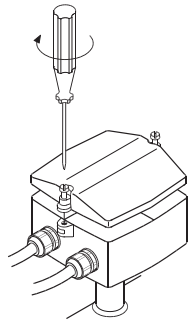

### Wall mounting

1. Mount bracket on a wall or on a horizontal or a vertical pipe using ordinary hose clips or duct straps.

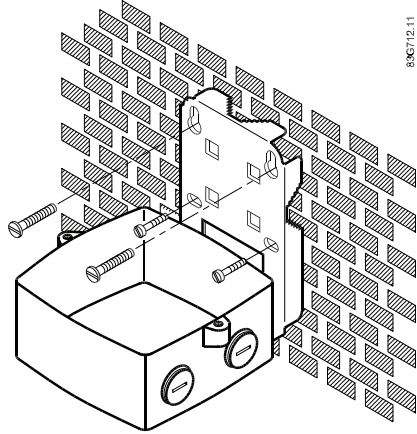

Figure 4-5 Wall mounting

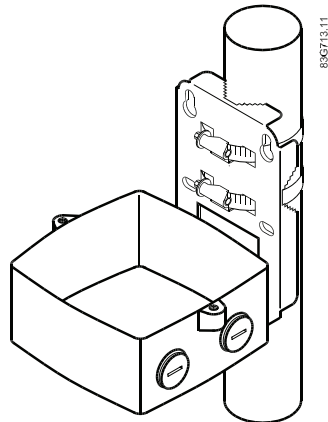

Figure 4-6 Pipe mounting - vertical

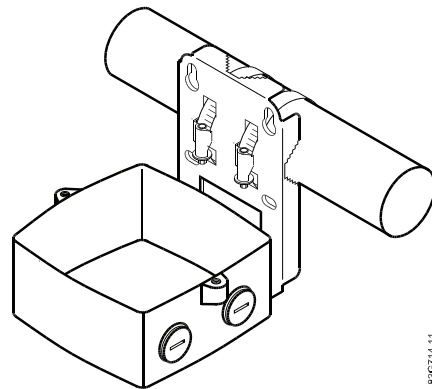
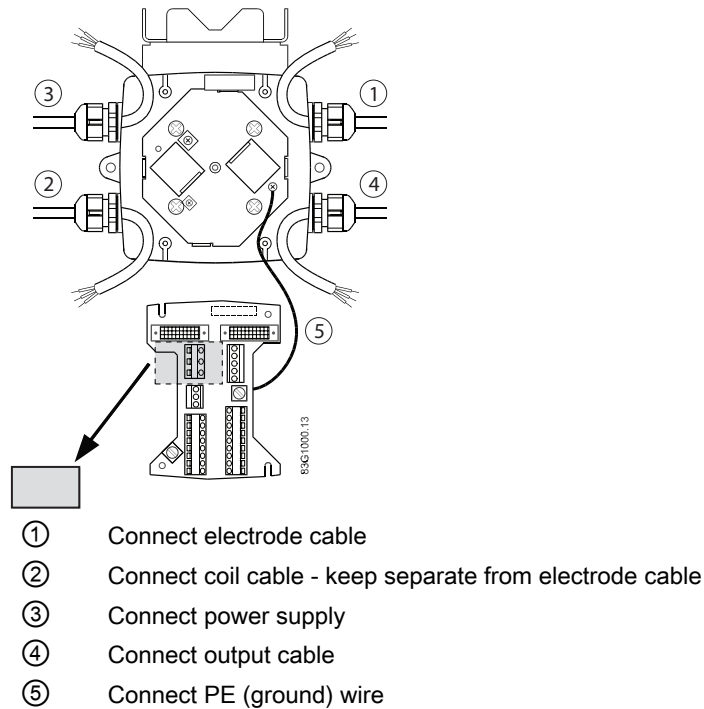

Figure 4-7 Pipe mounting - horizontal

2. Ensure that correct SENSORPROM® memory unit is mounted in wall/pipe mounting unit.
3. Fit M20 or 1/2" NPT cable glands for cables from bottom or sides of terminal box.

4. Mount earth wire in bottom of terminal box.



5. Mount connection plate in terminal box.

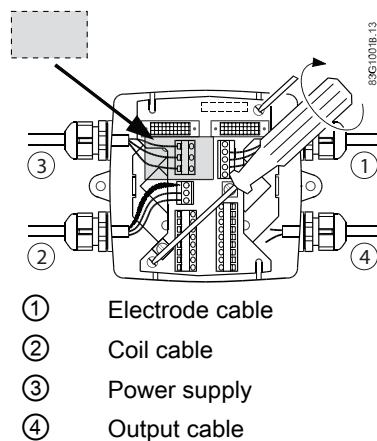

6. Fit coil, electrode, supply and output cables through cable glands and connect to connection plate as shown in Electrical connection (Page 38).

7. Fix connection plate with the two diagonally opposite screws.

8. Tighten cable glands to obtain optimum sealing.

<p><b>⚠ CAUTION</b></p> <p><b>Coil cable shield</b></p> <p>When remote mounted, power supply PE wire must be connected to PE terminal (⊕). Coil cable shield must be connected to SHIELD terminal.</p>
--

9. Mount transmitter on terminal box. Recommended torque value: 2.5 Nm.

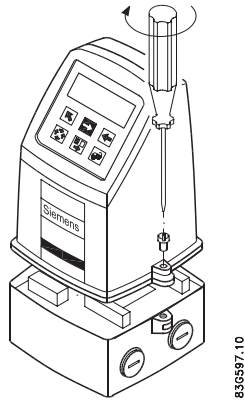

10. Transmitter is ready to be powered up.

<b>NOTICE</b>
<b>Direct sunlight</b>
Exposing the transmitter to direct sunlight may increase the operating temperature above its specified limit, and decrease display visibility.
A sun shield is available as accessory.

## 4.5 MAG 5000/6000 CT

Calibration sealing has been carried out at calibration.

MAG 6000 CT is installed like a Standard MAG 6000 except for the final sealing.

### 4.5.1 Installing hardware key

#### Use hardware key on non-verified transmitter

---

##### Note

##### Hardware key function

Setting of primary operating parameters is blocked during normal operation.

When key is mounted, access to all menu items is gained. When key is removed, primary settings are blocked in accordance with requirements in authorisation.

---

1. Mount hardware key on transmitter connection plate during setting of primary operating parameters such as  $Q_{max}$ , low-flow cut-off, units, approvals, etc. in connection with commissioning or calibration. See setup menus in appendix Transmitter menu overview (Page 79).

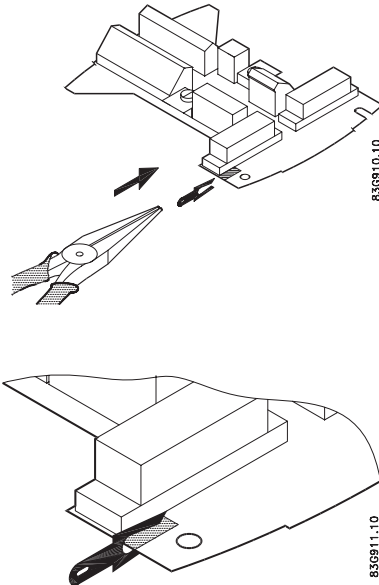

2. Remove hardware key after setting up and calibrating unit.  
This locks the menu structure and the selected settings.

## 4.5.2 Sealing of MAG 5000/6000 CT

### 4.5.2.1 Verification sealing

---

#### Note

The verification sealing is done at factory after initial verification.

---

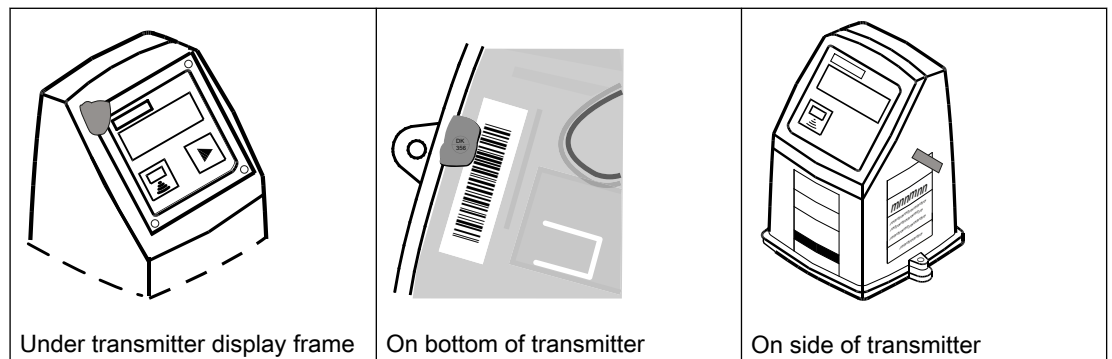

---

**Note**

**For type-approved and verified MID MAG 5000/6000 CT products**

The verification sealing may only be broken by an authorized person, with the acceptance and under direction of the local authorities.

---

**4.5.2.2 User sealing**

---

**Note**

User sealing has to be done after commissioning by an authorized person.

---

1. Drill through marked drilling holes in terminal box and transmitter/lid.
2. Seal the transmitter on both sides with either one or two wires, as shown below.

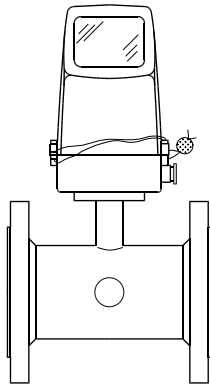

Compact version sealed with one wire

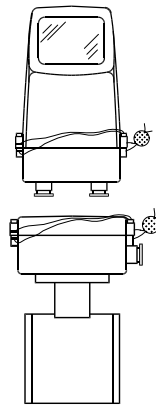

Remote version sealed with one wire

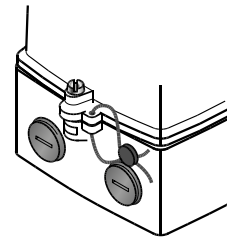

Compact version sealed with two wires

**4.5.3 Installation conditions**

**4.5.3.1 MI-001**

MAG 5000/6000 CT together with MAG 5100 W (7ME652) are approved for MI-001 under the following installation conditions.

- DN 50 to 300 (2" to 12") in any orientation
- DN 350 to 1200 (14" to 48") only in horizontal installation
- Compact or remote with max. 500 m (1640 ft.) cable
- Power supply 115 to 230 V AC and 12 to 24 V DC



Other restrictions may apply (see certificate).

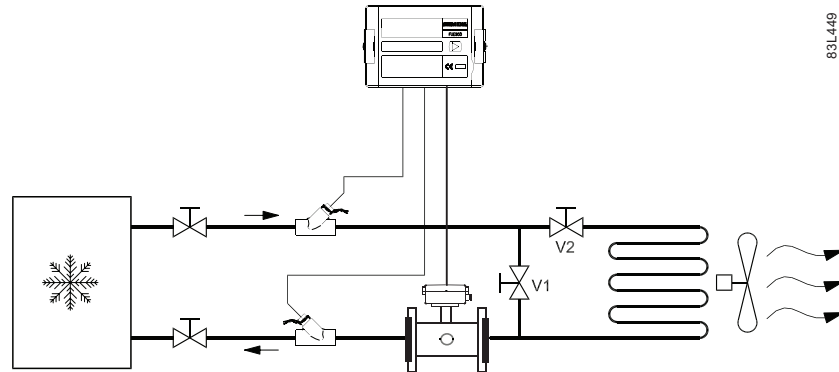

#### 4.5.3.2 PTB K7.2

MAG 5000/6000 CT together with MAG 5100 W (7ME652) are approved for PTB K7.2 under the following installation conditions.

##### SITRANS F M MAG 5100 W with MAG 5000/6000CT

- DN 15 to DN 300 (1/2" to 12") in any orientation
- DN 350 to DN 1200 (14" to 48") only in horizontal installation
- Compact or remote with max. 500 m (1640 ft.) cable

Other restrictions may apply (see certificate)

## 4.6 Turning transmitter/keypad

### Note

**Not allowed for MAG 5000/6000 CT**

Altering the orientation of the transmitter or keypad is prohibited for non-CT versions.

### Transmitter

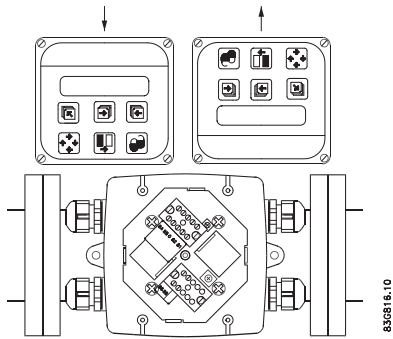

Figure 4-8 Transmitter can be mounted with its front in either direction indicated by the arrows without turning terminal box

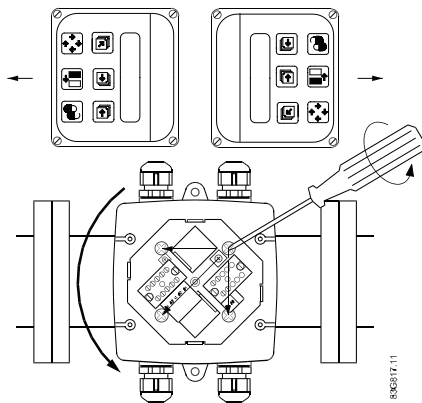
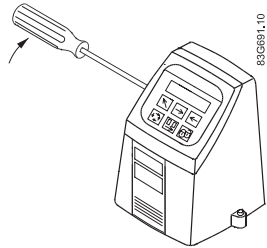

Figure 4-9 Terminal box can be rotated  $\pm 90^\circ$  in order to optimize viewing angle of transmitter display/keypad

1. Unscrew the four screws in bottom of terminal box.
2. Turn terminal box to required position.
3. Retighten screws firmly.

## Keypad

1. Remove outer frame using a screwdriver.



2. Loosen the four screws retaining keypad.

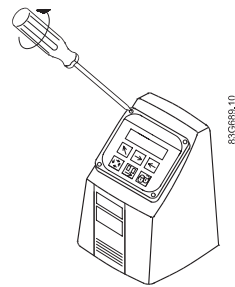

3. Withdraw keypad and turn it to required orientation.

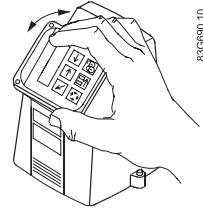

4.6 Turning transmitter/keypad

4. Tighten the four screws until a mechanical stop is felt in order to obtain IP67 enclosure.

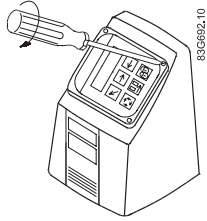

5. Snaplock outer frame onto keypad (click).

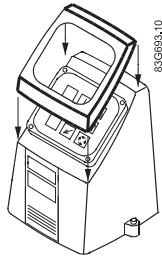

 **WARNING**

**The pertinent regulations must be observed for electrical installation.**

- Never install the device with the mains voltage switched on!
- Danger of electric shock!
- The electrodes and magnetic current line may only be connected when the device is not connected to the power supply.
- If the housing is under voltage (power supply), the cover may be unscrewed by qualified personnel only.

 **WARNING**

**Mains supply from building installation Class II**

A switch or circuit breaker (max. 15 A) must be installed in close proximity to the equipment and within easy reach of the operator. It must be marked as the disconnecting device for the equipment.

# 5.1 Electrical connection

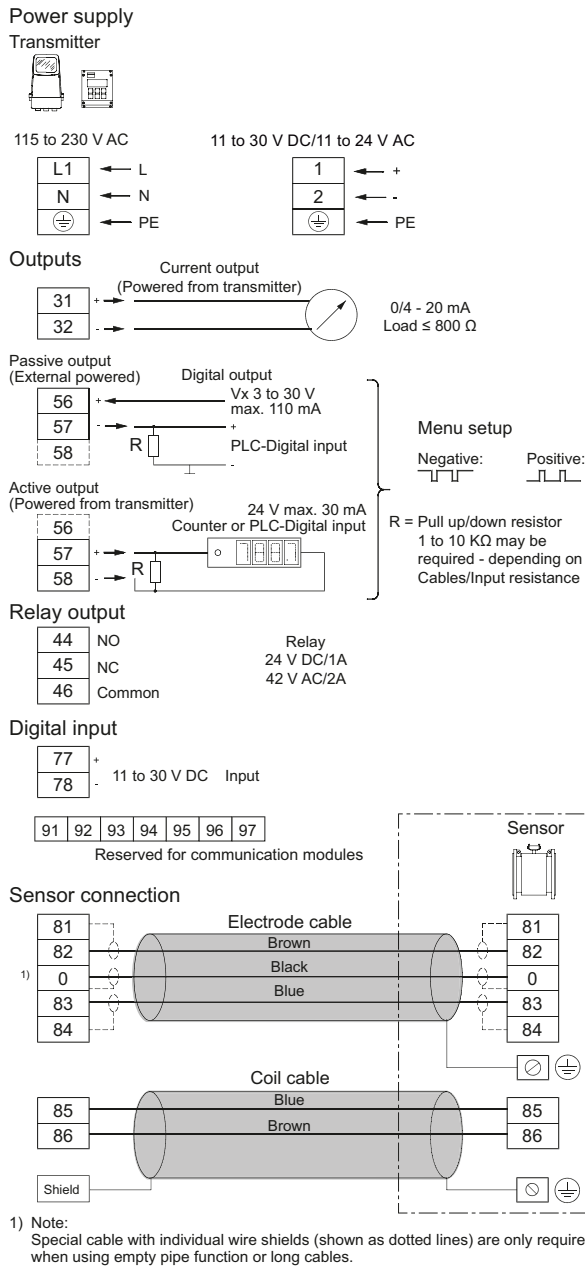

Figure 5-1 Wiring diagram

**Note**

Terminals 81 and 84 are only to be connected if special electrode cable with double screening is used, e.g. when empty pipe function or long cables are used.

### Mains supply

Mains supply 115 to 230 V AC from building installation Class II.

### Note

For DC installations it is recommend to install an under voltage relay or protection circuit in the application where there is a risk of low power supply below the specifications for more than 10 minutes.

### WARNING

#### Grounding

Connect mains protective earth wire to PE terminal in accordance with diagram (due to class 1 power supply).

### Mechanical counter

Connect a 1000  $\mu$ F capacitor (capacitor+ to terminal 56 and capacitor- to terminal 58) if a mechanical counter is connected to terminals 57 and 58 (active output).

### Output cables

Use screened cables if long cables are used in noisy environments.

### Digital output

If internal resistance of a load exceeds 10 k $\Omega$ , connect an external 10 k $\Omega$  load resistor in parallel to this load.

### WARNING

#### Intrinsically safe terminals

**Always** ensure that distance between cables/wires is **minimum 50 mm** in order to avoid that wires/terminals of intrinsically safe circuits get into contact with wires of other cables.

Fasten cables/wires in a way that they **cannot** get into contact with each other, not even in case of an error. Keep wire ends as short as possible.

## 5.2 Electrical connection PTB K7.2

Additional Electrical connection for PTB K7.2 approved MAG 5000/6000 CT with MAG 5100 W (7ME652)

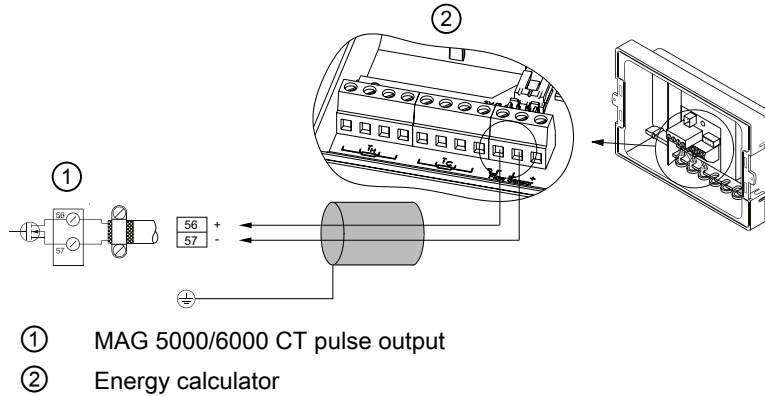

## 5.3 Connection of add-on modules

When the add-on module has been installed, the electrical connections are available on terminal rows 91-97.

### For more information

Refer to the relevant BUS communication Quick Start or Operating Instructions available on an included DVD or on the internet, at: [www.siemens.com/flowdocumentation](http://www.siemens.com/flowdocumentation) ([www.siemens.com/flowdocumentation](http://www.siemens.com/flowdocumentation)).



# Commissioning

In this chapter it is described how to commission the device via the local user interface (LUI). The display is described in details in section Local user interface (Page 42).

Furthermore, the following functions are described in details:

- Changing password (Page 44)
- Changing basic settings (Page 44)
- Changing operator menu setup (Page 47)
- Changing language (Page 48)

Detailed diagrams concerning the specific menu are shown in appendix menu diagrams.

For factory settings, see Factory settings (Page 95).

## 6.1 MAG 5000/6000 Blind

---

### Note

Does not have a display. All factory settings will be uploaded from the SENSORPROM® unit after power-up.

---

For sensor dependent factory settings, see Transmitter factory settings (Page 95).

### Changing settings

If other settings are required, a standard transmitter with display and similar power supply can be used.

1. Unscrew and remove MAG 5000/6000 Blind.
2. Mount standard MAG 5000/6000 transmitter.
3. Change required settings via display and keypad.  
All changed data will be stored in SENSORPROM® memory unit.
4. Remove standard transmitter and remount Blind transmitter.
5. Fasten screws holding transmitter.

New settings stored in SENSORPROM® memory unit will be uploaded in blind transmitter.

## 6.2 Local user interface

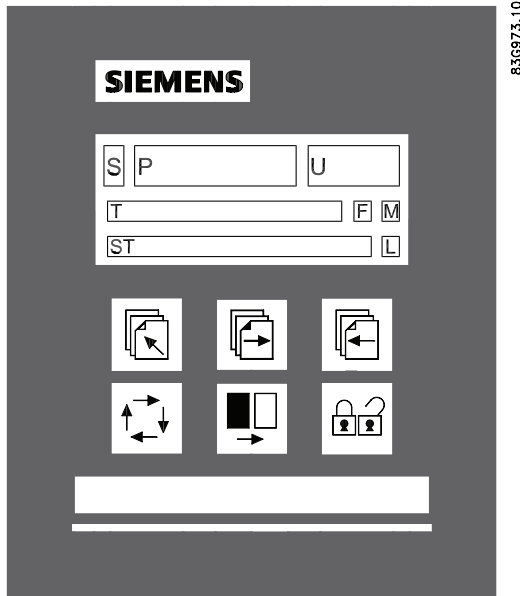

836973.10

- S Sign field
- P Primary field for numeric value flow rate, Totalizer 1 or Totalizer 2)
- U Unit field
- T Title line with individual information according to operator or setup menu selected.
- ST Subtitle line which will either add information to the title line or keep individual information independent of the title line.
- F Alarm field. Two flashing triangles will appear in case of a fault condition.
- M Mode field
- L Lock field

Figure 6-1 Local User Interface

### Mode field symbols







	Communication mode		Language mode		Sensor characteristics
	Service mode		Basic settings		Reset mode
	Operator menu		Output		Operator-active
	Product identity		External input		Operator-inactive

### Lock field symbols

	Ready for change		Access to submenu
	Value locked		RESET MODE: Zero setting of totalizers and initialization of setting

## Keypad

The keypad is used to set the flowmeter. The keys function as follows:

TOP UP KEY		This key (when held for 2 sec.) is used to switch between operator menu and setup menu. In transmitter setup menu, a short press will cause a return to previous level.
FORWARD KEY		This key is used to step forward through the menus. It is the only key normally used by the operator.
BACKWARD KEY		This key is used to step backwards through the menus.
CHANGE KEY		With this key settings or numerical values are changed.
SELECT KEY		With this key figures to be changed are selected.
LOCK/UNLOCK KEY		This key enables the operator to change settings and it gives access to submenus.

## 6.3 Menu structure

---

### Note



#### Menus disabled on MAG 5000/6000 CT

Due to legal requirements, some parameters are disabled on MAG 5000/6000 CT.

---

The menu is built up of two parts. An **operator menu** and a **setup menu**, see Transmitter menu overview (Page 79).

### Operator menu

The operator menu is for daily operation. It is customized in the operator menu setup. The transmitter always starts up in operator menu No. 1. The forward  and the backward keys  are used to step through the operator menus.



#### Setup menu

The setup menu is for commissioning and service only. Access to the setup menu is gained by pressing the top up key  for 2 seconds. The setup menu operates in two modes:

- View mode
- Setup mode

**View mode** is a read-only mode. The pre-selected settings can only be scanned.









**Setup mode** is a read and write mode. The pre-selected settings can be scanned and changed. Access to the setup mode is password-protected. The factory set password is 1000.

Access to a submenu in the setup menu is gained by pressing the lock key . Press the top up key  briefly to return to the previous menu. Press longer (2 sec.) to exit the setup menu and return to operator menu No. 1.

## 6.4 Changing password

The setup menu is password-protected in order to ensure that only authorized personnel can make any changes in transmitter settings.

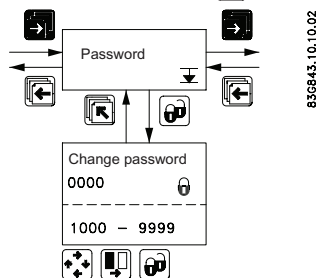

Change password as follows:

1. Press top up key  for 2 sec.
2. Enter password.
3. Use forward key  or backward key  to reach password menu.
4. Press lock/unlock key  to unlock password.
5. Use select key  and change key  to change password.
6. Press lock/unlock key  to confirm new password.
7. Press top up key  two times to exit setup mode.



The factory-set password is 1000, but it can be changed to any value between 1000 and 9999.

Factory setting of password can be re-established as follows:

1. Switch off power supply.
2. While pressing top up key  - switch on power supply.
3. Release top up key  after 10 sec.

## 6.5 Changing basic settings

In the basic settings menu it is possible to set the following parameters:

Parameter	Description
Main frequency	Selection of main power supply frequency corresponding to the country in which the flowmeter is installed (e.g. 60 Hz in America).
Flow direction	Selection of correct flow direction in pipe.
Customer units	Setting of user defined volume and time units.
Q <sub>max</sub>	Setting of measuring range, analog outputs and frequency output. Also individual dimension-dependent setting of value, decimal point, unit and time.
Q <sub>max 2</sub>	Setting of measuring range, analog outputs and frequency output. Also individual dimension-dependent setting of value, decimal point, unit and time. This menu is only visible if chosen as external digital input.
Totalizer	Setting of unit and decimal point.

Parameter	Description
Low flow cut-off	Setting of a percentage of selected $Q_{max}$ . This filters noise in installation reducing fluctuations in display and all outputs.
Empty pipe cut-off	When set to "On" the alarm will indicate when sensor is running empty. All readings, display and outputs, will indicate zero.
Velocity unit	Setting of velocity unit per time unit
Error level	Selecting error level at which flowmeter will detect an error.









**Note**

Totalizer 2 is not visible when batch is selected as digital output.

**Note**

$Q_{max}$  2 is visible only when chosen as digital input.

Change basic settings as follows:

1. Press top up key  for 2 sec.
2. Enter password.
3. Use forward key  to reach basic settings menu.
4. Press lock/unlock key  to unlock settings.
5. Use forward key  or backward key  to reach relevant menu.
6. Press lock/unlock key  to unlock settings.
7. Use select key  and change key  to change settings.
8. Press lock/unlock key  to confirm new settings.

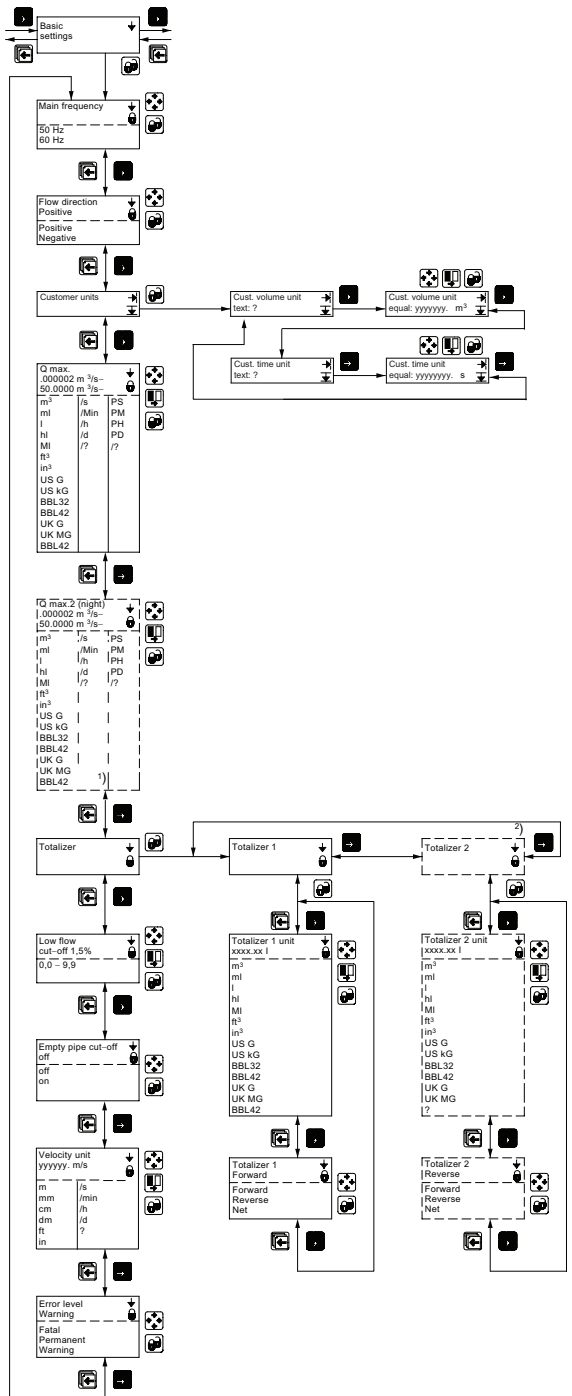

6.5 Changing basic settings

9. Repeat steps 5-8 to change other settings.
10. Press top up key  two times to exit setup mode.



Decimal point can be positioned and units set individually for flow rate in totalizer 1 and totalizer 2.

### Changing decimal point position

1. Enter the respective totalizer menu.
2. Use select key  to position cursor below decimal point.
3. Use change key  to move decimal point to requested position.



### Changing units

---

**Note****Menus disabled on MAG 5000/6000 CT**

Due to legal requirements, some parameters are disabled on MAG 5000/6000 CT. Only available units are m<sup>3</sup>/h and m<sup>3</sup>.

---



1. Use select key  to position cursor below unit.
2. Press change key  until requested unit is displayed.

## 6.6 Changing operator menu setup



In the operator menu the menus required for daily operation of the flowmeter are shown. It is possible to hide and change some of the menus in the operator menu. This is done in the operator menu setup menu, see diagram Operator menu setup (Page 92).

### Customizing menus in operator menu

To customize the menus in the operator menu perform the following steps:

1. Press top up key  for 2 sec.
2. Enter password.
3. Use forward key  or backward key  to reach operator menu.

### Changing text in line 1

1. Press lock/unlock key  to unlock setting.
2. Use change key  to select desired text.
3. Press lock/unlock key  to confirm selected text.









---

**Note**





If "Text" is selected in line 2, this line functions as a heading for the value shown in line 3. Otherwise it shows the actual value of the reading selected.

---

### Enabling two readings

1. Use forward key  to reach requested menu.
2. Press lock/unlock key  to unlock setting.
3. Use select key  to move cursor to upper line.
4. Use change key  to select requested reading.
5. Press lock/unlock key  to confirm selection.
6. Use select key  to move cursor to line 3.
7. Use change key  to select desired setting.
8. Press lock/unlock key  to confirm new setting.
9. Repeat steps 1-8 for each requested menu.







### Showing/hiding menus in operator menu

1. Use forward key  to reach requested menu.
2. Press lock/unlock key  to unlock setting.
3. Use select key  to move cursor to  $\sqrt{/}$  symbol.
4. Press change key  to select visible ( $\sqrt{/}$ ) or hidden ( $-/$ ).
5. Press lock/unlock key  to confirm new setting.

## 6.7 Changing language

It is possible to change language in transmitter. Default language is English, but it can be changed to various other languages.

Change language as follows:

1. Press top up key  for 2 sec.
2. Enter password.
3. Use forward key  or backward key  to reach language menu.
4. Press lock/unlock key  to unlock language.
5. Use change key  to select desired language.
6. Press lock/unlock key  to confirm new language.
7. Press top up key  two times to exit setup mode.



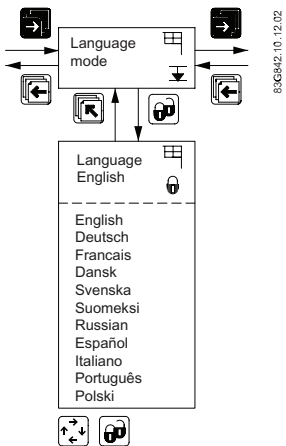



# Operating

This chapter describes the various menus of the transmitter in details. The menu diagrams are shown in appendix Menu diagrams.

## 7.1 Output settings

Three outputs are available:

- Current output (range and time constant); terminals 31 and 32.
- Digital output (pulse, frequency, error, limit, or batch settings); terminals 56, 57, and 58.
- Relay output (error, limit, and batch settings); terminals 44, 45, and 46.

### Current output

In the current output menu it is possible to select current output direction, range and time constant, see also Current output (Page 83).

If current output "4-20 mA + Alarm" is selected, then alarm level and alarm differentiation may also be defined.

"Alarm level" defines if an alarm should be above 21 mA "High" or below 3.6 mA "Low".

"Alarm diff." defines whether or not the alarm should vary according to selected error level. Error level "Fatal". "Permanent" or "Warning" is selected in "Basic settings".

If Alarm differentiation is set to "Yes", depending on the Alarm level setting, the current output will show:

Alarm level	Output / Error level		
	Fatal	Permanent	Warning
Low	1.3 mA	2 mA	3 mA
High	23 mA	22 mA	21.5 mA

If Alarm differentiation is set to "No", depending on the Alarm level setting, the current output will show:

Alarm level	Output
Low	3.5 mA
High	22.6 mA

For setting of error level, see Digital output / Relay output - Error level (Page 84).

If current output is not used, it must be set to "Off".

## Digital output

Digital output can be used to configure various settings:

- Pulse (volume/pulse, pulse output, pulse width, pulse polarity, and time constant), see Digital output - pulse (Page 83).
- Frequency (frequency output, max frequency, and time constant), see Digital output - frequency (Page 84).
- Error settings (level and number), see Digital output / Relay output - Error level (Page 84) and Digital output / Relay output - Error number (Page 84).
- Limit settings (number of setpoints, setpoint settings, and hysteresis), see Digital output / Relay output - Direction/limit (Page 85).
- Batch settings (quantity, time and counter settings, and time constant), see Digital output / Relay output - Batch (Page 85).

---

### Note

#### Batch settings

Only MAG 6000.

Not available in MAG 5000, MAG 5000 CT and MAG 6000 CT.

---

### Note

When relay is set to batch function, pulse/frequency is not available on digital output.

---

## Relay outputs

Relay output can be used to configure various settings:

- Error settings (level and number), see Digital output / Relay output - Error level (Page 84) and Digital output / Relay output - Error number (Page 84).
- Limit settings (number of setpoints, setpoint settings, and hysteresis), see Digital output / Relay output - Direction/limit (Page 85).
- Batch settings (quantity, time and counter settings, and time constant), see Digital output / Relay output - Batch (Page 85).
- Cleaning (cycle time), see Relay output - Cleaning (Page 85).

---

### Note

#### Batch settings

Only MAG 6000.

Not available in MAG 5000, MAG 5000 CT and MAG 6000 CT.

---

### Note

#### Cleaning

If a cleaning unit is installed together with transmitter, relay output must **always** be used to operate this unit. It cannot be used for other purposes.

---

## 7.2 External input

By applying 11 to 30 V DC to terminals 77 and 78, it is possible to perform:

- Batch control (start, stop, hold/continue)
- Reset totalizer
- Force/freeze output
- $Q_{\max} 2$  (night)

See External input (Page 87).

---

### Note

#### Batch settings

Only MAG 6000.

Not available in MAG 5000, MAG 5000 CT and MAG 6000 CT.

---

### Note

#### Manual cleaning

If the digital input is used for manual cleaning, the relay output also automatically changes to "cleaning".

---

## 7.3 Sensor characteristics

The sensor characteristics menu shows:

- If a SENSORPROM® is installed or not
- Suppress error P 40 (SENSORPROM® not installed)
- Sensor size
- Calibration factor
- Correction factor
- Excitation

See Sensor characteristics (Page 88).

---

### Note







If a SENSORPROM is not installed, check the sensor characteristics to see if they match the product label and the previous customer settings.

---

## 7.4 Reset mode

The reset mode is used for resetting/presetting totalizers or for restoring the factory settings.

## Resetting

1. Press top up key  for 2 sec.
2. Enter password.
3. Use forward key  or backward key  to reach reset mode menu.
4. Press lock/unlock key  to enter reset menu.
5. Press forward key  to reach totalizer to be reset or default setting menu.
6. Press lock/unlock key  to start resetting.









If restoring of factory settings is required:

1. Press lock/unlock key  again to confirm destruction of customized settings.  
See Reset mode (Page 89)











## Zero point adjustment (MAG 6000 SV only)

### Auto adjustment

Before auto zero point adjustment is carried out ensure that valves to and from flowmeter are completely closed and that flow velocity in sensor is zero.

1. Press top up key  for 2 sec.
2. Enter password.
3. Use forward key  or backward key  to reach reset mode menu.
4. Press lock/unlock key  to enter reset menu.
5. Press forward key  to reach zero adjust menu.
6. Press lock/unlock key  to enter the menu.
7. Use change key  to select "auto".
8. Press forward key  to view actual offset (lower line in display). Value will be zero after adjustment has been performed.
9. Press lock/unlock key  to start adjustment.

### Manual adjustment.

1. Press top up key  for 2 sec.
2. Enter password.
3. Use forward key  or backward key  to reach reset mode menu.
4. Press lock/unlock key  to enter reset menu.
5. Press forward key  to reach zero adjust menu.
6. Press lock/unlock key  to enter the menu.
7. Use change key  to select "manual".
8. Press forward key  and then select key  and change key  to key in offset value.
9. Press lock/unlock key  to start adjustment.

Zero point can be adjusted manually in range -1.000 to +1.000 m<sup>3</sup>/s. If value outside this range is keyed in, zero point adjustment will not be implemented.

See Reset mode - MAG 6000 SV (Page 90).

## 7.5 Service mode

All outputs of the transmitter can be forced-controlled in the service mode menu, see Service mode (Page 91).

It is possible to check whether the outputs are functioning.

Error pending and status log lists are also accessible from this menu and the operating time (in days) can be read.

The forced control is stopped and all previous settings are reinitialized the moment the service mode is left by pressing top up key .

## 7.6 MAG 5000 CT and MAG 6000 CT settings

### Internal totalizers

Depending on the type of approval it is possible to reset the internal totalizers. The type of approval is selected in the reset menu with the hardware key mounted. It is possible to choose between:

- Hot/cold water
- Other liquids

Resetting of totalizers by electrical input is not possible.

#### Hot/cold water

- Totalizer 1 is allocated to forward flow (cannot be reset)
- Totalizer 2 is allocated to reverse flow (cannot be reset)

#### Other liquids

Both totalizer 1 and totalizer 2 are allocated to measure the net flow, i.e. any reverse flow will make the totalizers count backwards.

- Totalizer 1 cannot be reset.
- Totalizer 2 can be reset if the flow velocity in the meter pipe is <0.25 m/s. When the totalizer is reset, the pulse output register will also be reset.

### Output

- When choosing hot water, changing the output settings is not allowed and the output setting menus are not shown in display.
- When choosing cold water or other liquids, all output settings can be changed.

## 7.7 MAG 6000 SV

### Excitation frequency

The MAG 6000 SV excitation frequency can be changed in Sensor characteristics (Page 88) to one of the following frequencies:

- $1 \frac{9}{16}$  Hz
- $3 \frac{1}{8}$  Hz
- $6 \frac{1}{4}$  Hz
- $12 \frac{1}{2}$  Hz
- 25 Hz
- 44 Hz

---

#### Note

Calibration has been made with the frequency stored in SENSORPROM® memory unit. A change in excitation frequency is not recommended and will always mean decreased measuring accuracy. In some instances, however, it may be necessary to change frequency due to pulsating flow from piston pumps or other resonance frequencies from surroundings.

It is highly recommended to carry out a External input (Page 53) after changing the excitation frequency as the offset is affected by the frequency selected. When this is done, the decrease in measuring accuracy can be kept below 1% o.r.

A too high frequency for the sensor used will cause a coil current alarm indication.



## Service and maintenance

The device is maintenance-free. However, a periodic inspection according to pertinent directives and regulations must be carried out.

An inspection can include check of:

- Ambient conditions
- Seal integrity of the process connections, cable entries, and cover screws
- Reliability of power supply, lightning protection, and grounds

<b>NOTICE</b>
Repair and service must be carried out by Siemens authorized personnel only.

**Note**

Siemens defines flow sensors as non-repairable products.

Under ideal conditions the flowmeter will operate continuously with no manual adjustment or intervention required.

The SITRANS F M Vericator is an external tool developed for verifying the SITRANS F M system, installation, and application. It is a highly advanced instrument, which carries out the complex verification of the entire flowmeter system according to unique SIEMENS patented principles. The verification test is automated and the instrument easy to use, so no human error or influence will affect the verification.

### 8.1 Transmitter check list

If unstable/wrong measurements occur, it is often due to insufficient/wrong earthing or potential equalization. If earthing connection is OK, check transmitter as described below, and sensor as described in sensor check lists (see relevant sensor Operating Instructions).

The easiest way to check the transmitter in a SITRANS F M installation is to replace the transmitter with another transmitter with a similar power supply.

As all settings are stored in and downloaded from the SENSORPROM®, replacement is easily done and no extra settings need to be made.

#### Check transmitter

If no replacement transmitter is available, check transmitter according to the following check table.

Power on transmitter		
0	Display light on?	Yes ⇒ 1
		No ⇒ 2

Power on transmitter		
1	Flashing error triangles?	Yes ⇒ Check error table
		No ⇒ 1.2
1.2	Output and display readings OK?	Yes ⇒ 1.2.1
		No ⇒ 1.2.2
1.2.1	Transmitter OK	Check application Check installation/sensor/earthing connection etc.
1.2.2	Check cables/connections Check connection board Check pins in transmitter multiplug	OK ⇒ 1.2.1
		Not OK ⇒ correct fault
2	Check cables/connections Check connection board Check pins in transmitter multiplug	OK ⇒ 2.1
		Not OK ⇒ Correct fault
2.1	Output readings OK?	Yes ⇒ 2.1.1
		No ⇒ 2.1.2.
2.1.1	Display defective	Replace display
2.1.2	Transmitter defective	Replace transmitter

**Note**

**Sensor check list**

Check list for sensors are included in the relevant sensor Operating Instructions.

## 8.2 Technical support

If you have any technical questions about the device described in these Operating Instructions and do not find the right answers, you can contact Customer Support:

- Via the Internet using the **Support Request:**  
Support request (<http://www.siemens.com/automation/support-request>)
- Via Phone:
  - Europe: +49 (0)911 895 7222
  - America: +1 423 262 5710
  - Asia-Pacific: +86 10 6475 7575

Further information about our technical support is available on the Internet at Technical support (<http://support.automation.siemens.com/WW/view/en/16604318>)

### Service & Support on the Internet

In addition to our documentation, we offer a comprehensive knowledge base online on the Internet at:

Service and support (<http://www.siemens.com/automation/service&support>)

There you will find:

- The latest product information, FAQs, downloads, tips and tricks.
- Our newsletter, providing you with the latest information about your products.
- Our bulletin board, where users and specialists share their knowledge worldwide.
- You can find your local contact partner for Industry Automation and Drives Technologies in our partner database.
- Information about field service, repairs, spare parts and lots more under **Services**.

### Additional Support

If you have additional questions about the device, please contact your local Siemens representative and offices at:

Local contact person (<http://www.automation.siemens.com/partner>)

## 8.3 Return procedure

Enclose the bill of lading, return document and decontamination certificate in a clear plastic pouch and attach it firmly to the outside of the packaging.

### Required forms

- Delivery note
- Return goods delivery note (<http://www.siemens.com/processinstrumentation/returngoodsnote>)  
with the following information:
  - Product (item description)
  - Number of returned devices/replacement parts
  - Reason for returning the item(s)
- Decontamination declaration (<http://www.siemens.com/sc/declarationofdecontamination>)  
With this declaration you warrant "that the device/replacement part has been carefully cleaned and is free of residues. The device/replacement part does not pose a hazard for humans and the environment."  
If the returned device/replacement part has come into contact with poisonous, corrosive, flammable or water-contaminating substances, you must thoroughly clean and decontaminate the device/replacement part before returning it in order to ensure that all hollow areas are free from hazardous substances. Check the item after it has been cleaned. Any devices/replacement parts returned without a decontamination declaration will be cleaned at your expense before further processing.

## **8.4 Recalibration**

Siemens AG offers to recalibrate the sensor. Please use the recalibration MLFB 9LA110-8Qxxx-xxxx, where xxx-xxxx indicate customer-specific configuration.

---

### **Note**

For recalibration the SENSORPROM® memory unit must always be returned with the sensor.

---

# Diagnostics and Troubleshooting

## 9.1 Diagnostics

### Error system

Transmitter system is equipped with an error and status log system with 4 groups of information.

(I) Information - system will continue to measure as normal, relay and current outputs will not be affected.

(W) Warning - system will continue to measure, but an event that may cause a system malfunction and require operator attention has occurred. The cause of the error may disappear on its own.

(P) Permanent error - may cause malfunction in the application and operator attention is required.

(F) Fatal error - is essential for the operation of the flowmeter. Immediate operator attention is required.

Two menus are available in service and operator menus for registration of information and errors.

- Error pending
- Status log

---

#### Note

##### Registration of errors in different modes

- In setup mode (local dialog) errors are entered only to Error pending list and not to Error log list, and not registered on physical outputs (current or relay).
  - In service mode errors are entered to both Error pending and Error log lists, but not registered on physical outputs (current or relay).
- 

#### Note

##### Power-off

Both error pending and status logs are reset at power-off.

---

### Error pending

The first 9 pending errors are stored in the error pending list. When the error is corrected, it is removed from the error pending list.

The acceptance level for "error pending" can be individually configured to a particular application.

The acceptance level is set in the basic settings menu (Page 44).

**Acceptance levels**

The following three acceptance levels are selectable.

- Fatal error: Only fatal errors are registered as errors
- Permanent error: Permanent and fatal errors are registered as errors
- Warning (Default value): Warnings, permanent and fatal errors are registered as errors

Error information is displayed in title and subtitle lines, see display layout (Page 42). Title line will show time in days, hours and minutes since occurrence of error. Subtitle line will flash between an error text and a remedy text. Error text will indicate type of error (I, W, P or F), error number, and error text. Remedy text will inform operator of action to take to remove error.

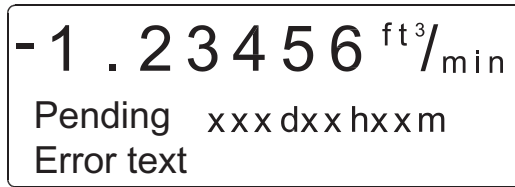

**Status log**

The latest 9 errors are stored in the status log. Errors are stored in the status log for 180 days, even if they are corrected.

**Alarm field**

The alarm field on the display will always flash when an error is pending.

**Error output**

The digital and relay output can be activated individually error by error (error level). The relay output is default selected to error level. An output can also be selected to activate on a single error number.

The alarm field, error output and error pending always operate together.

**Operator menu**

Error pending and status log are as default enabled (✓) in the operator menu.

## 9.2 List of error numbers

Error No.	Error text Remedy text	Comment	Output status	Input status
1	<i>I1 - Power on</i> OK	Device powered on	Active	Active
2	<i>I2 - Add-on module</i> Applied	A new module has been applied to the system	Active	Active
3	<i>I3 - Add-on module</i> Install	An add-on module is defect or has been removed. This can be an internal add-on module	Active	Active
4	<i>I4 - Param. corrected</i> OK	A less vital parameter in the transmitter has been replaced by its default value	Active	Active
20	<i>W20 - Totalizer 1</i> Reset manually	During initialisation the check of the saved totalizer value has failed. It is not possible to rely on the saved totalizer value anymore. The totalizer value must be reset manually in order to rely on future readings	Active	Active
20	<i>W20 - Totalizer 2</i> Reset manually	During initialisation the check of the saved totalizer value has failed. It is not possible to rely on the saved totalizer value anymore. The totalizer value must be reset manually in order to rely on future readings	Active	Active
21	<i>W21 - Pulse overflow</i> Adj. pulse settings	Actual flow is too big compared with pulse width and volume/pulse	Reduced pulse width	Active
22	<i>W22 - Batch timeout</i> Check installation	Duration of batching has exceeded a predefined maximum time	Batch output on zero	Active
23	<i>W23 - Batch overrun</i> Check installation	Batch volume has exceeded a predefined maximum overrun volume	Batch output on zero	Active
24	<i>W24 - Batch neg. flow</i> Check flow direction	Negative flow direction during batch	Active	Active
30	<i>W30 - Overflow</i> Adj. $Q_{\max}$	Flow is above $Q_{\max}$ settings	Max. 120 %	Active
31	<i>W31 - Empty pipe</i>	Pipe is empty	Zero	Active
40	<i>P40 - SENSORPROM®</i> Insert/change	SENSORPROM® unit not installed	Active	Active
41	<i>P41 - Parameter range</i> Switch off and on	A parameter is out of range. The parameter could not be replaced by its default value. The error will disappear at the next power-on	Active	Active

9.2 List of error numbers

Error No.	Error text Remedy text	Comment	Output status	Input status
42	<i>P42 - Current output</i> Check cables	Current loop is disconnected or the loop resistance is too big	Active	Active
43	<i>P43 - Internal error</i> Switch off and on	Too many errors occurred at the same time. Some errors are not detected correctly	Active	Active
44	<i>P44 - CT SENSORPROM®</i> Replace	SENSORPROM® unit has been used as CT version	Active	Active
49	<i>P49 - Protection violation</i> Switch off and on	Internal protection of the device has been violated.	Active	
60	<i>F60 - CAN comm. error</i> Transmitter/AOM	CAN bus communication error. An add-on module, the display module or the transmitter is defective	Zero	Inactive
61	<i>F61 - SENSORPROM® error</i> Replace	It is not possible to rely on the data in SENSORPROM® unit anymore	Active	Active
62	<i>F62 - SENSORPROM® ID</i> Replace	The SENSORPROM® unit ID does not comply with the product ID. The SENSORPROM® unit is from another type of product SITRANS F C, SITRANS F US etc.	Zero	Inactive
63	<i>F63 - SENSORPROM®</i> Replace	It is not possible to read from the SENSORPROM® unit anymore	Active	Active
70	<i>F70 - Coil current</i> Check cables	Coil excitation has failed	Active	Active
71	<i>F71 - Internal error</i> Replace transmitter	Internal conversion error in ASIC	Active	Active

Symptom	Output signals	Error code	Cause	Remedy
Empty display	Minimum		1. No power supply	Power supply Check MAG 5000/6000/6000 I for bended pins on the connector
			2. MAG 5000/6000/6000 I defective	Replace MAG 5000/6000/6000 I



Symptom	Output signals	Error code	Cause	Remedy	
No flow signal	Minimum		1. Current output disabled	Turn on current output	
			2. Digital output disabled	Turn on digital output	
			3. Reverse flow direction	Change direction	
		F70	Incorrect or no coil current	Check cables/connections	
		W31	Measuring pipe empty	Ensure that the measuring pipe is full	
		F60	Internal error	Replace MAG 5000/6000/6000 I	
		Undefined	P42	1. No load on current output	Check cables/connections
			2. MAG 5000/6000/6000 I defective	Replace MAG 5000/6000/6000 I	
		P41	Initializing error	Switch off MAG 5000/6000/6000 I, wait 5 sec. and switch on again	
Indicates flow with no flow in pipe	Undefined		Measuring pipe empty	Select empty pipe cut-off	
			Empty pipe cut-off is OFF	Ensure that the measuring pipe is full	
			Electrode connection missing/ electrode cable is insufficiently screened	Ensure that electrode cable is connected and sufficiently screened	
Unstable flow signal	Unstable		1. Pulsating flow	Increase time constant	
			2. Conductivity of medium too low	Use special electrode cable	
			3. Electrical noise potential between medium and sensor	Ensure sufficient potential equalization	
			4. Air bubbles in medium	Ensure medium does not contain air bubbles	
			5. High concentration of particles or fibres	Increase time constant	
Measuring error	Undefined		Incorrect installation	Check installation	
		P40	No SENSORPROM® unit	Install SENSORPROM® unit	
		P44	CT SENSORPROM® unit	Replace SENSORPROM® unit or reset SENSORPROM® unit with MAG CT transmitter	
		P49	Protection violation	Switch off MAG 5000/6000/6000I, wait 5 sec. and switch on again.	
		F61	Defective SENSORPROM® unit	Replace SENSORPROM® unit	
		F62	Wrong type of SENSORPROM® unit	Replace SENSORPROM® unit	
		F63	Defective SENSORPROM® unit	Replace SENSORPROM® unit	
		F71	Loss of internal data	Replace MAG 5000/6000/6000 I	
		Maximum	W30	Flow exceeds 100% of $Q_{max}$ .	Check $Q_{max}$ (Basic Settings)
			W21	Pulse overflow Volume/pulse too small	Change volume/pulse
			Pulse width too large	Change pulse width	
Measuring approx. 50%			Missing one electrode connection	Check cables	
Loss of totalizer data	OK	W20	Initializing error	Reset totalizer manually	

*9.2 List of error numbers*

<b>Symptom</b>	<b>Output signals</b>	<b>Error code</b>	<b>Cause</b>	<b>Remedy</b>
##### Signs in display	OK		Totalizer roll over	Reset totalizer or increase totalizer unit
Empty pipe error message when Empty pipe set to off	OK	W31	Empty pipe error	Switch off MAG 5000/6000/6000I, wait 5 sec. and switch on again

## Technical data

### 10.1 Technical specifications



Technical specifications for MAG 5000/6000		
<b>Mode of operation and design</b>	Measuring principle	Electromagnetic with pulsed constant field
	Empty pipe	Detection of empty pipe (special cable required in remote mounted installation)
	Excitation frequency	Depends on sensor size
	Electrode input impedance	$> 1 \times 10^{14} \Omega$
<b>Input</b>	<b>Digital input</b>	11 to 30 V DC, $R_i = 4.4 \text{ k}\Omega$
	Activation time	50 ms
	Current	$I_{\text{DC } 11 \text{ V}} = 2.5 \text{ mA}$ , $I_{\text{DC } 30 \text{ V}} = 7 \text{ mA}$
<b>Output</b>	<b>Current output</b>	
	Signal range	0 to 20 mA or 4 to 20 mA, Alarm
	Load	$< 800 \Omega$
	Time constant	0.1 to 30 s, adjustable (for batch: fixed at 0.1 s)
	<b>Digital output</b>	
	Frequency	0 to 10 kHz, 50% duty cycle (uni/bidirectional)
	Pulse (active)	DC 24 V, 30 mA, $1 \text{ k}\Omega \leq R_i \leq 10 \text{ k}\Omega$ , short-circuit protected (power supplied from flowmeter)
	Pulse (passive)	DC 3 to 30 V, max. 110 mA, $200 \Omega \leq R_i \leq 10 \text{ k}\Omega$ (powered from connected equipment)
	Time constant	0.1 to 30 s, adjustable (for batch: fixed at 0.1 s)
	<b>Relay output</b>	
	Time constant	Changeover relay, same as current output
Load	42 V AC/2 A, 24 V DC/1 A	
<b>Low flow cut off</b>	0 to 9.9% of maximum flow	
<b>Galvanic isolation</b>	All inputs and outputs are galvanically isolated	
<b>Max. measuring error (incl. sensor and zero point)</b>	MAG 5000	$0.4\% \pm 1 \text{ mm/s}$ (for $v > 0.1 \text{ m/s}$ )
	MAG 6000	$0.2\% \pm 1 \text{ mm/s}$ (for $v > 0.1 \text{ m/s}$ )
<b>Functions</b>	Flow rate, 2 totalizers, low-flow cut-off, empty pipe cut-off, flow direction, error system, operating time, uni/bidirectional flow, limit switches, pulse output, control for cleaning and batch	

Technical specifications for MAG 5000/6000		
Rated operation conditions	Ambient temperature	
	Operation	Standard IP67, 19", blind and SV versions: -20 to +60 °C (-4 to +140 °F) CT version: -25 to +55 °C (-13 to +131 °F)
	Storage	-40 to +70 °C (-40 to +158 °F)
Mechanical load	18 to 1000 Hz, 3.17 G rms, sinusoidal in all directions to IEC 68-2-36	
Degree of protection	IP67/NEMA 4X/6 to IEC 529 and DIN 40050 (1 mH <sub>2</sub> O 30 min.)	
EMC performance	EN 61326-1 (industrial environments)	
	EN 61326-2-5	
Display and keypad	Totalizer	Two eight-digit counters for forward, net or reverse flow
	Display	Background illumination with alphanumeric text, 3 x 20 characters to indicate flow rate, totalized values, settings and faults; Reverse flow indicated by negative sign
	Time constant	Time constant as current output time constant
Design	Enclosure material	Fiber glass reinforced polyamide; optional (IP67 only): AISI 316 stainless steel
	Dimensions	See dimensional drawings
	Weight	0.75 kg (2 lb)
Power supply	115 to 230 V AC +10% -15%, 50 to 60 Hz, Fuse: 500 mA T 11 to 30 V DC or 11 to 24 V AC; Fuse 2 A T	
Power consumption	115 to 230 V AC: 17 VA 24 V AC: 9 VA, I <sub>N</sub> = 380 mA, I <sub>ST</sub> = 8 A (30 ms) 12 V DC: 11 W, I <sub>N</sub> = 920 mA, I <sub>ST</sub> = 4 A (250 ms)	
Certificates and approvals	CE, C-UL US general purpose, C-tick, CSA/FM Class 1, div 2	
	Custody transfer approval (MAG 5000/6000 CT)	Cold water approval: PTB K7.2, MI-001
Communication	MAG 5000	Without communication or HART as option
	MAG 6000 / MAG 6000 CT	Prepared for client mounted add-on modules: HART, MODBUS RTU/RS485, FOUNDATION Fieldbus H1, DeviceNet, PROFIBUS PA, PROFIBUS DP as add-on modules

**Transmitter IP67/NEMA 4X/6 compact polyamide**

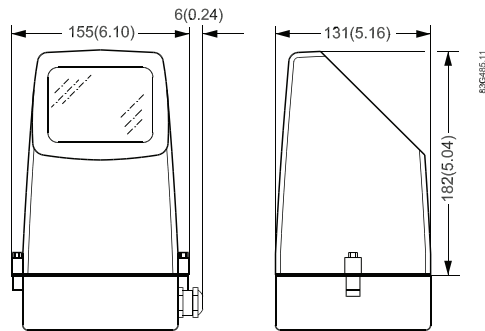

Weight: MAG 5000/6000: 0.75 kg (1.65 lbs)

**Transmitter IP67/NEMA 4X/6 wall-mounted polyamide**

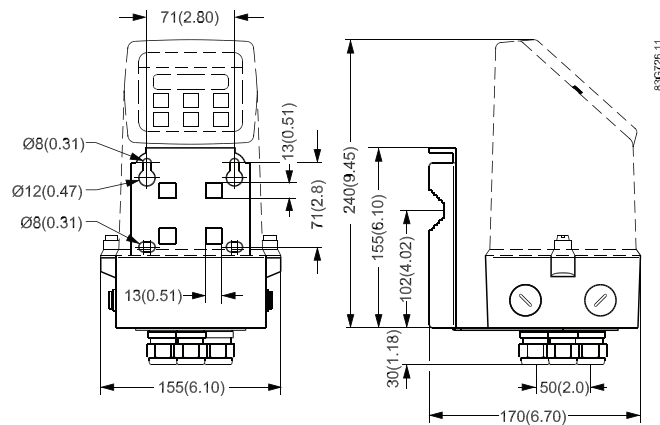

Weight (transmitter and wall mounting bracket): 1.65 kg (3.64 lbs)

## 10.2 Accuracy

For accuracy reference conditions, see table Reference conditions for sensor calibration.

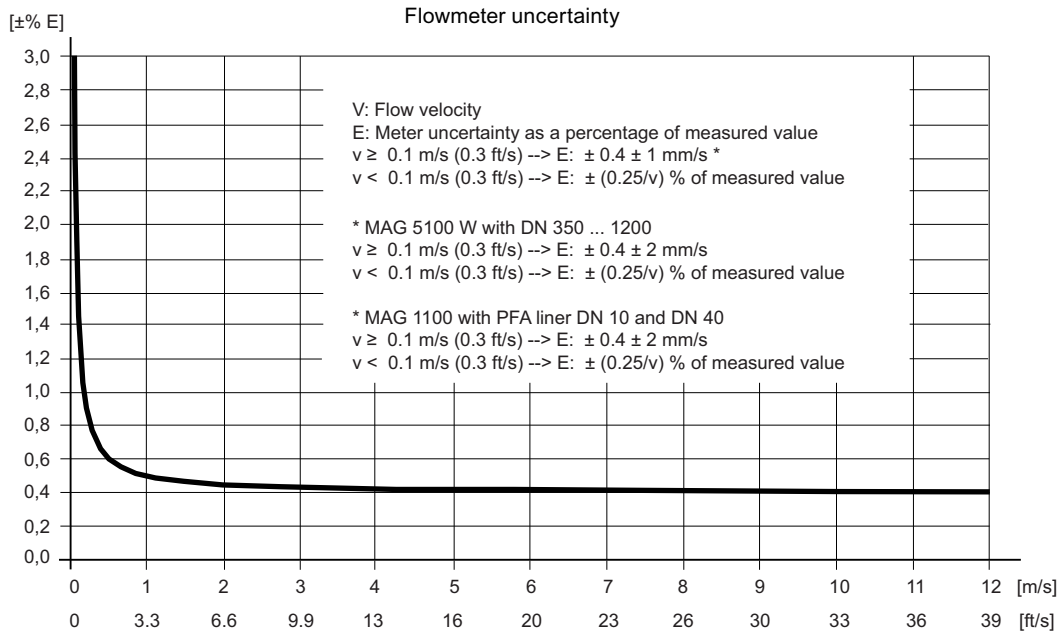

Figure 10-1 MAG 5000 with MAG 1100, MAG 1100 F, MAG 5100 W, MAG 3100 and MAG 3100 P and MAG 6000 with MAG 1100 (PFA), MAG 1100 F (PFA)

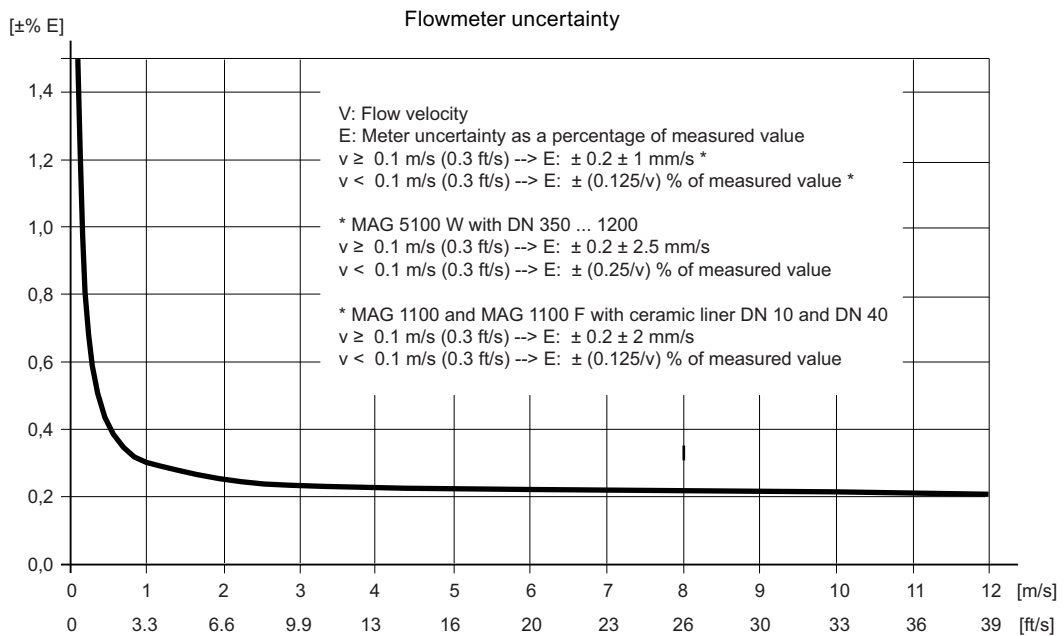

Figure 10-2 MAG 6000 with MAG 1100 (not PFA), MAG 1100 F (not PFA), MAG 5100 W, MAG 3100 and MAG 3100 P

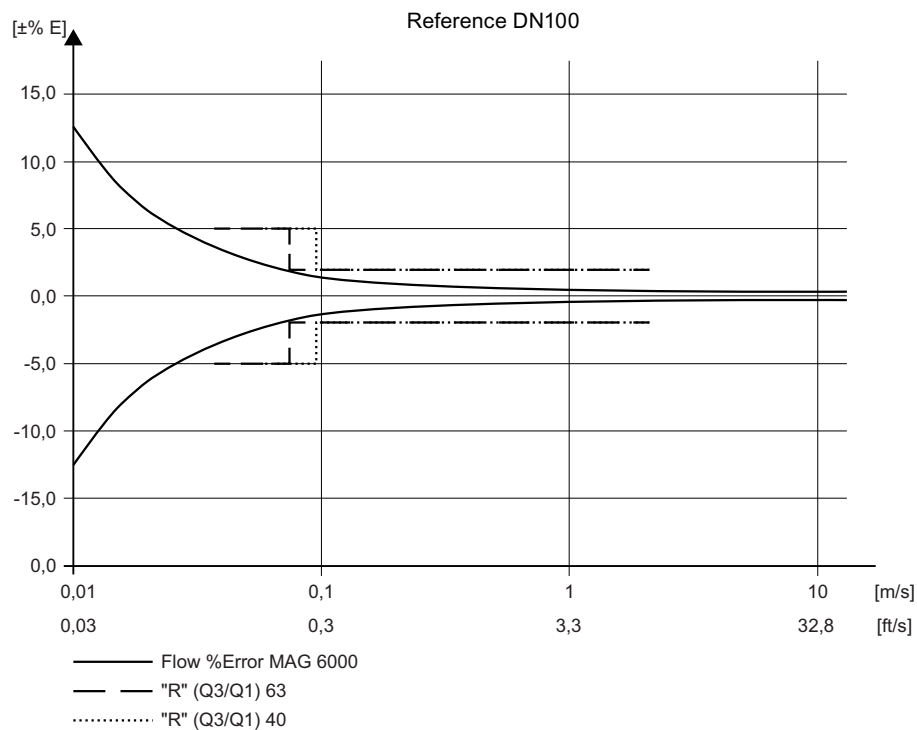

Figure 10-3 MID limits

**Note**

**Uncertainties for MAG 5000/6000 CT systems under MID requirements**

± 5% for flowrate between Q1 and Q2

± 2% for flowrate between Q2 and Q4 if media temperature ≤ 30°C

More detailed installation conditions can be found in the certificate.

**Reference conditions**

(ISO 9104 and DIN/EN 29104)

A calibration certificate is shipped with every sensor and calibration data is stored in SENSORPROM memory unit.

Table 10-1 Reference conditions for sensor calibration

Medium temperature	20°C ± 5°C (68°F ± 9°C)
Ambient temperature	20°C ± 5°C (68°F ± 9°C)
Supply voltage	U <sub>n</sub> ± 1%
Warming-up time	30 minutes

10.3 Output characteristics

Incorporation in conductive pipe section Inlet section	10 x DN (DN ≤ 1200/48") 5 x DN (DN > 1200/48")
Outlet section	5 x DN (DN ≤ 1200/48") 3 x DN (DN > 1200/48")
Flow conditions	Developed flow profile

Table 10-2 Additions in the event of deviations from reference conditions

Current output	As pulse output ± (0.1% of actual flow + 0.05% FSO)
Effect of ambient temperature Display/frequency/pulse output Current output	< ± 0.003% / °C act. < ± 0.005% / °C act.
Effect of supply voltage	< 0.005% of measuring value on 1% change
Repeatability	± 0.1% of actual flow for V ≥ 0.5 m/s (1.5 ft/s) and conductivity ≥ 10 µS/cm

## 10.3 Output characteristics

### Current output

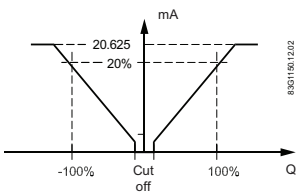
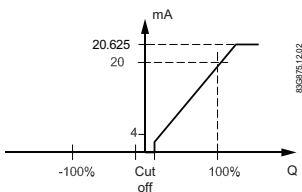
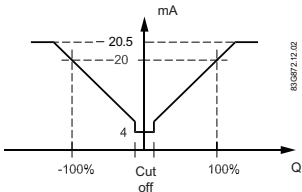
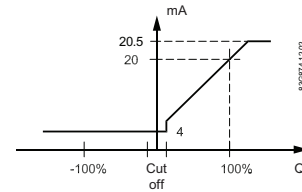
Output characteristics	Bidirectional mode	Unidirectional mode
0 to 20 mA		
4 to 20 mA		

### Frequency output

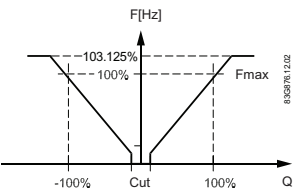
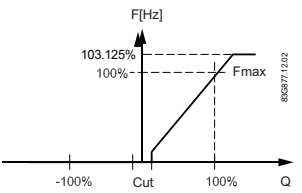
Bidirectional mode	Unidirectional mode
	



Pulse output

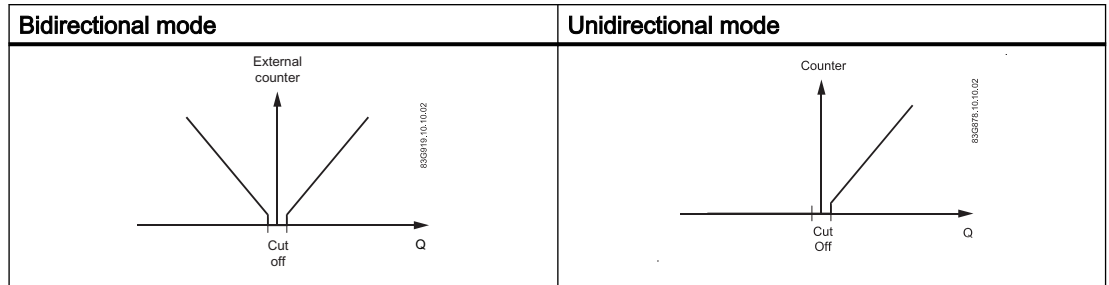

Relay output

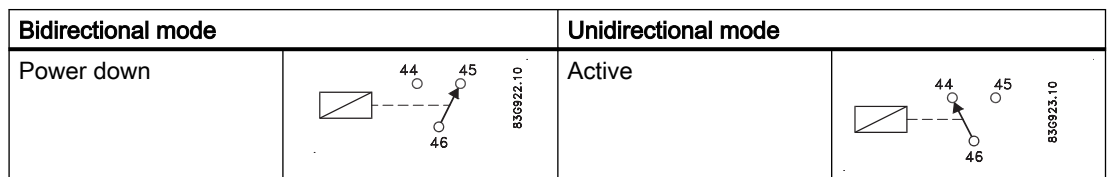

Error relay output

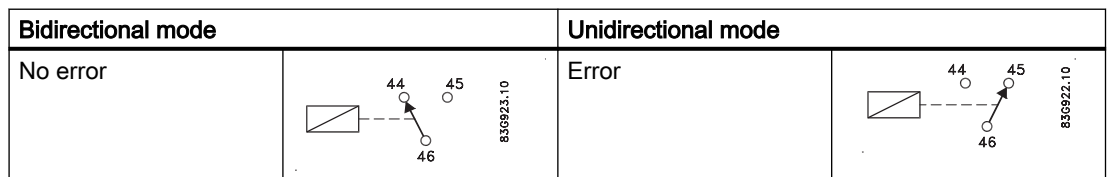

Limit switch (can be used as direction switch)

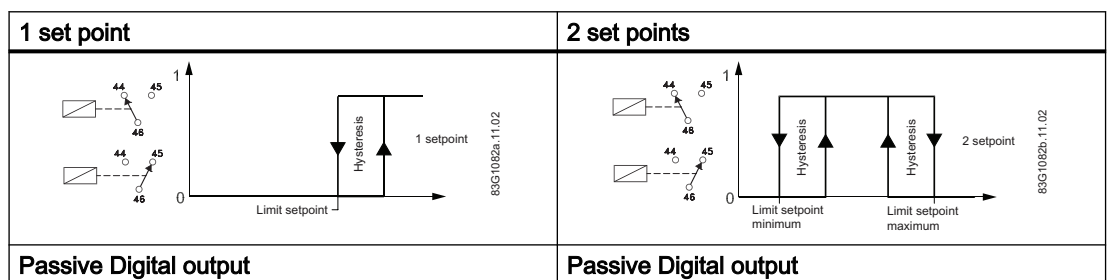

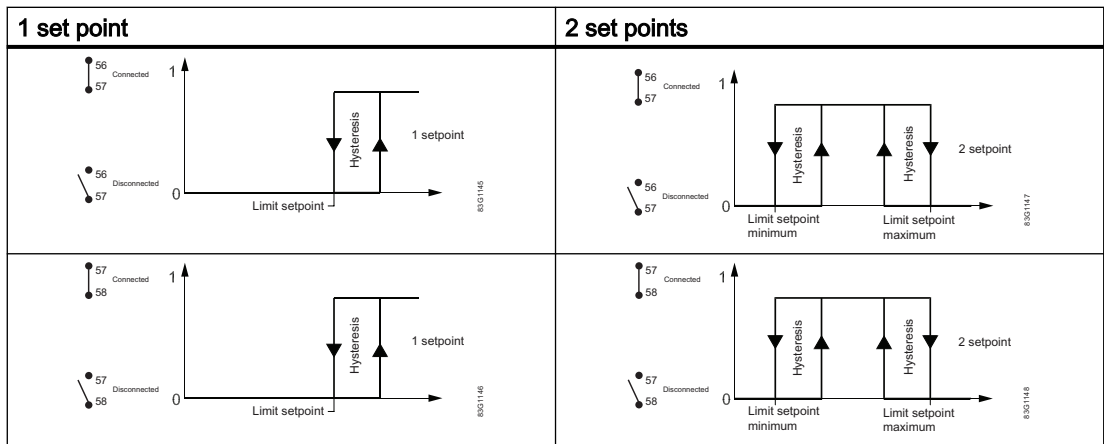

Limit/direction

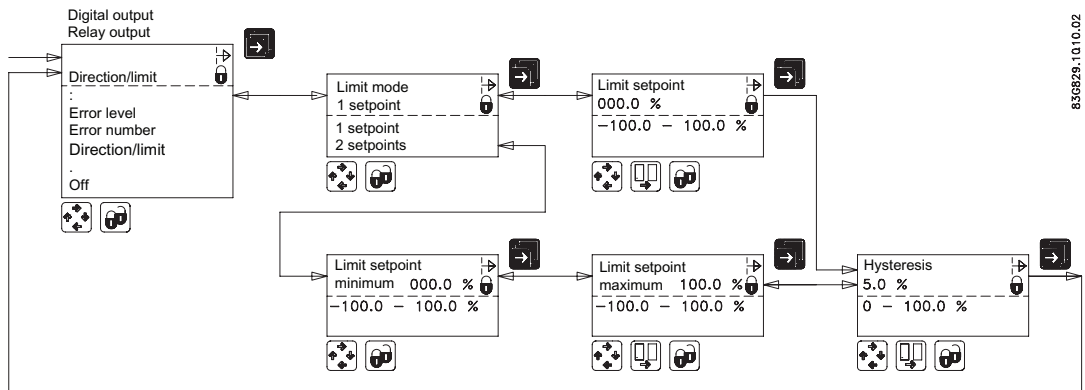

Limit switches are available for both digital and relay outputs.

**Direction mode:** 1 set point at 0% flow; hysteresis 5%.

If 2 set points must activate 2 separate outputs, a single set point has to be selected individually for digital as well as relay outputs.

Batch on digital output

Unidirectional mode (forward flow only)

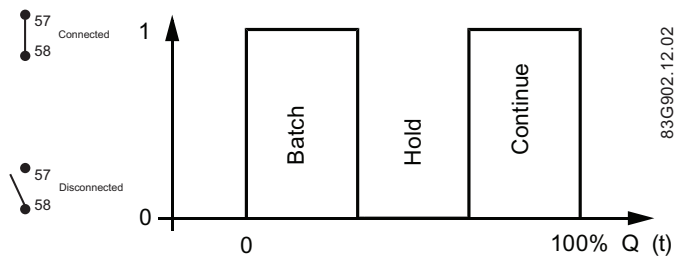

### Totalizer lap

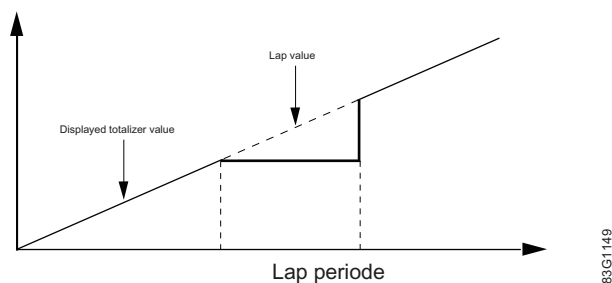

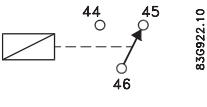
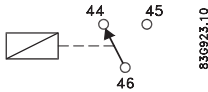

### Batch on relay output

Unidirectional mode (forward flow only)			
Hold		Batch	

## 10.4 Cable data

### Description

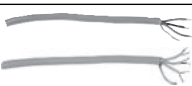
Electrode or coil cable (standard)	
Electrode cable, double shielded (for empty pipe detection or low conductivity fluids)	
Cable kit with standard coil cable and electrode cable double shielded (also available as low noise cable for MAG 1100 sensor)	

### Technical data

		Standard cable (electrode/coil)	Double-shielded cable (electrode)
Basic data	No. of conductors	3	3
	Sqr. area	1.5 mm <sup>2</sup>	0.25 mm <sup>2</sup>
	Screen	Yes	Double
	Color code	Brown, blue, black	Brown, blue, black
	Outside color	Grey	Grey
	Ext. diameter	7.8 mm	8.1 mm
	Conductor	Flexible CU	Flexible CU
	Isolation material	PVC	PVC

10.5 Cable requirements

		Standard cable (electrode/coil)	Double-shielded cable (electrode)
Ambient temperature	Flexible installation	-5 to +70°C (23 to 158°F)	-5 to +70°C (23 to 158°F)
	Non-flexible installation	-30 to +70°C (-22 to 158°F)	-30 to +70°C (-22 to 158°F)
Cable parameter	Capacity	161.50 pF/m	-
	Inductance	0.583 μH/m	-
	L/R	43.83 μH/Ω	-

For more information on cable lengths, empty pipe detection, and conductivity, see Operating Instructions for relevant sensor.

## 10.5 Cable requirements

		Coil cable	Electrode cable
<b>Basic data</b>	No. of conductors	2	3
	Min. sqr. area	0.5 mm <sup>2</sup>	0.2 mm <sup>2</sup>
	Screen	Yes	Yes
	Max. capacitance	N/A	350 pF/m
<b>Max. cable loop resistance</b>	Media temperature:		
	< 100 °C	40 Ω	N/A
	> 200 °C	6 Ω	N/A
<b>Cable glands on sensor</b>	M20x1.5 gland - Cable ø 5 to 13 mm (0.20 to 0.51 inches)		
	½ NPT gland - cable ø 5 to 9 mm (0.20 to 0.35 inches)		

 **WARNING**

**Cable glands**

For Ex zone 1 installations only certified cable glands with protection type "e" can be used for the power supply and the coil cable. The cable glands must be approved for the actual temperature and cable dimension.





# Spare parts/Accessories

# A

## A.1 Ordering of spare parts

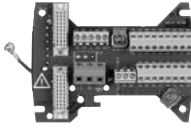
Ensure that your ordering data is not outdated. The latest ordering data is always available on the Internet: SIOS catalog (<https://support.industry.siemens.com/cs/products?dtp=Catalog&mfn=ps&pnid=17318&lc=en-US>)

## A.2 Spare parts

Description	
Connection plate	
SENSORPROM® memory unit	
Display unit	
Communication modules for MAG 6000	

### A.3 Sun shield

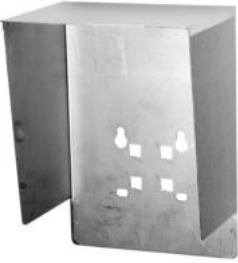
Description	
Sun shield	

## Menu diagrams

### B.1 Transmitter menu overview

The menu diagrams shown on the following pages apply to MAG 5000/6000 as well as MAG 6000 I.

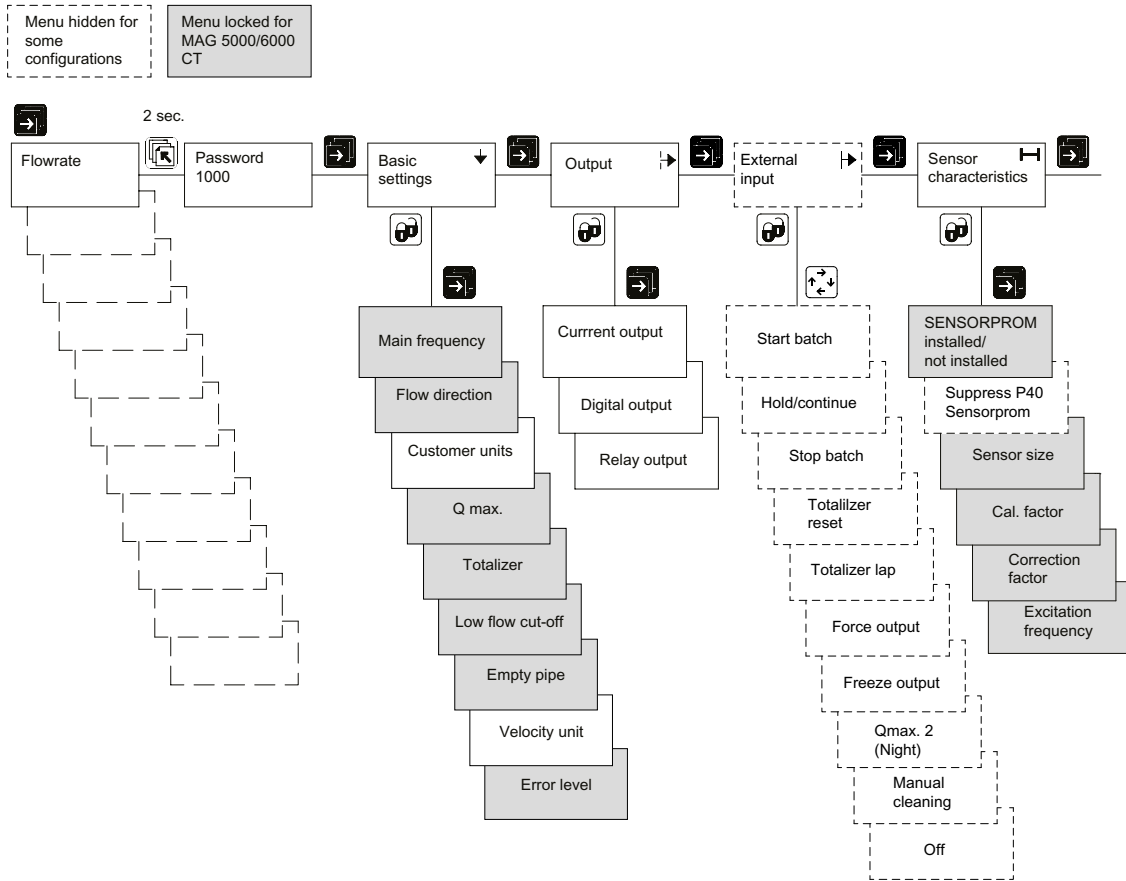

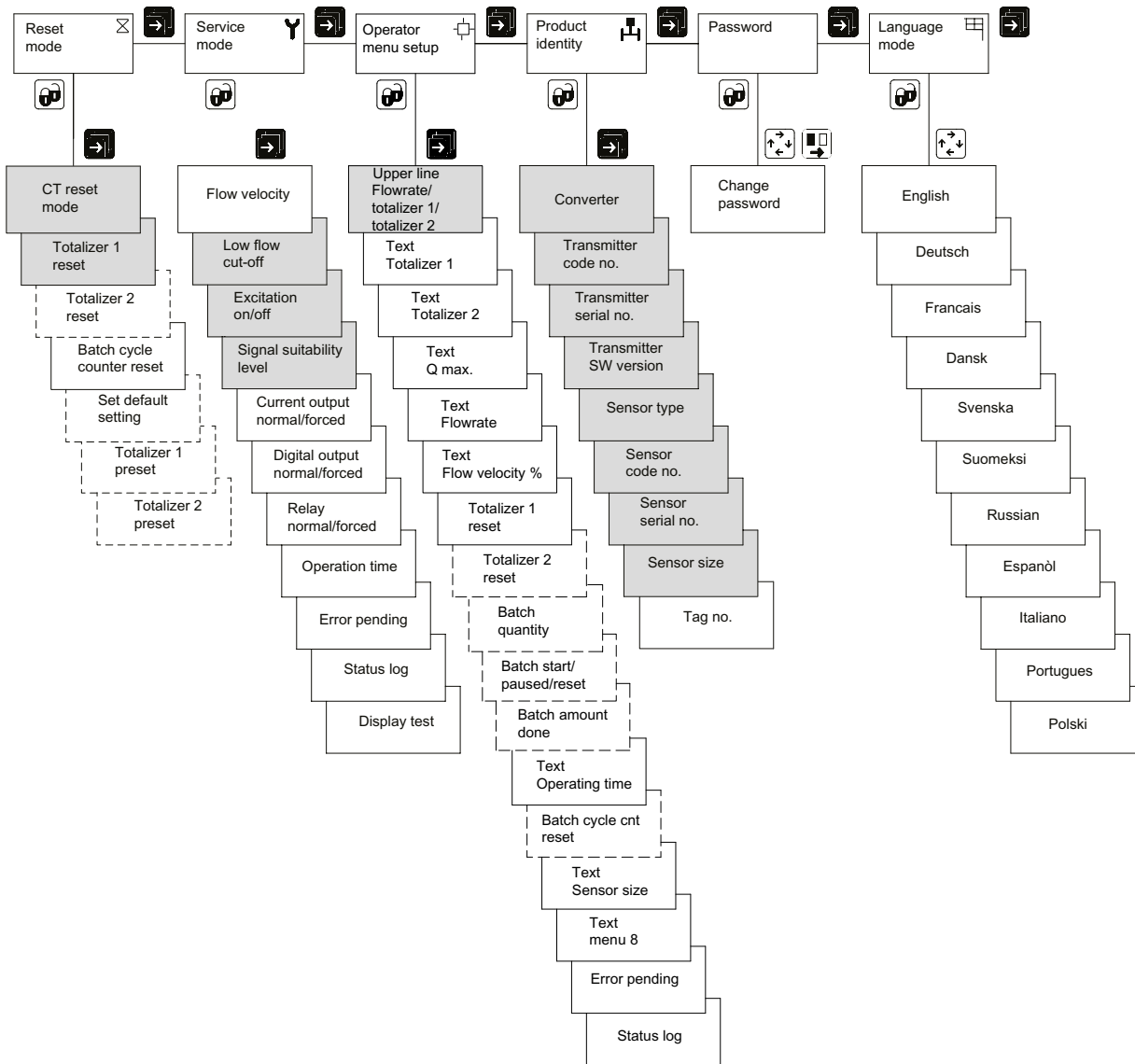

## B.2 Basic settings

**Note**

**Locked or hidden menus**

Depending on your configuration some menus might be locked or hidden.



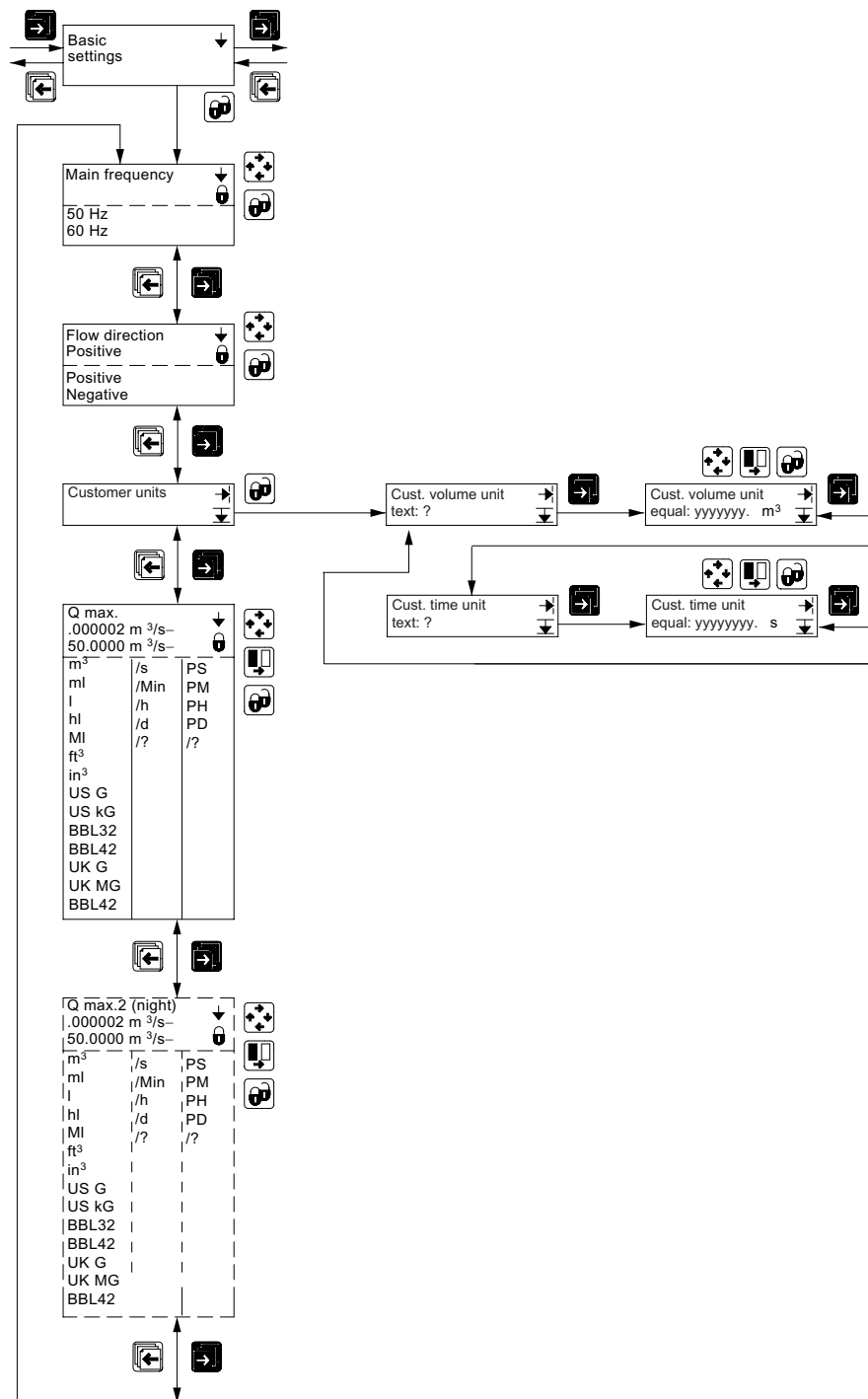

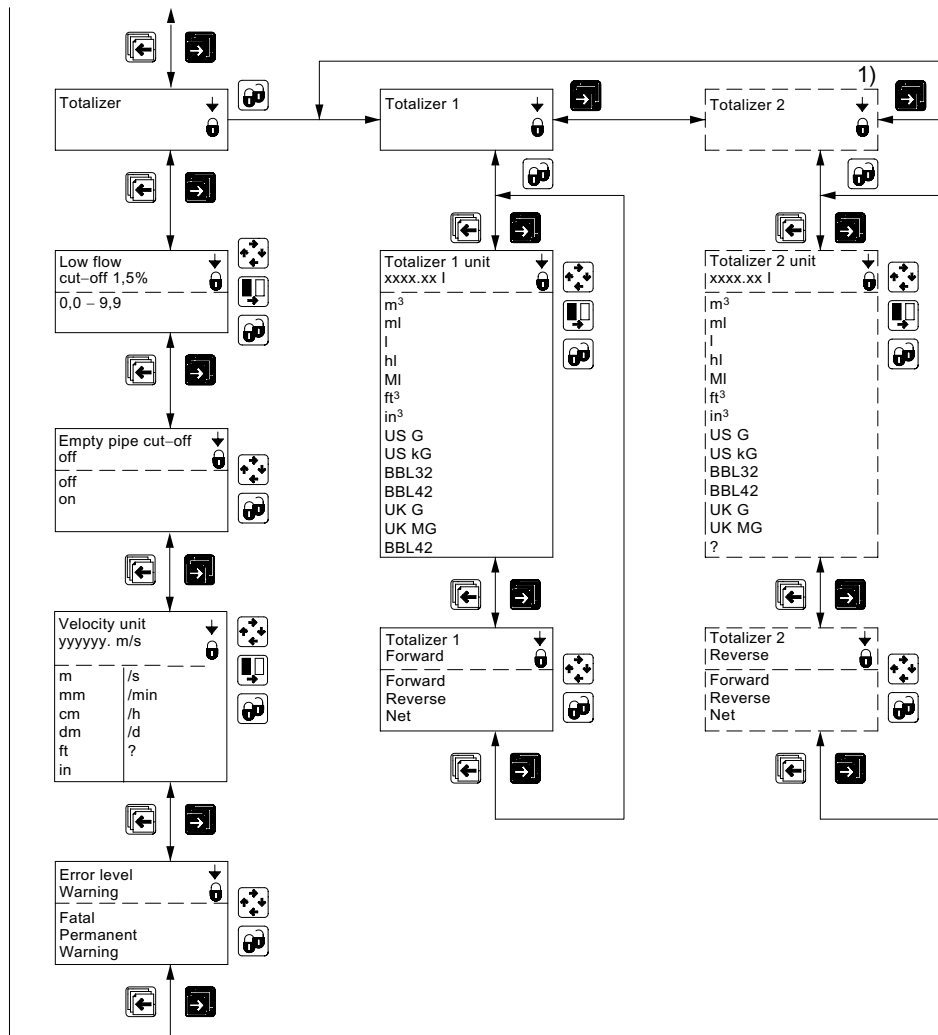

1) When batch is selected on digital output or relay, Totalizer 2 is not shown because it is controlled by the batch function.

## B.3 Current output

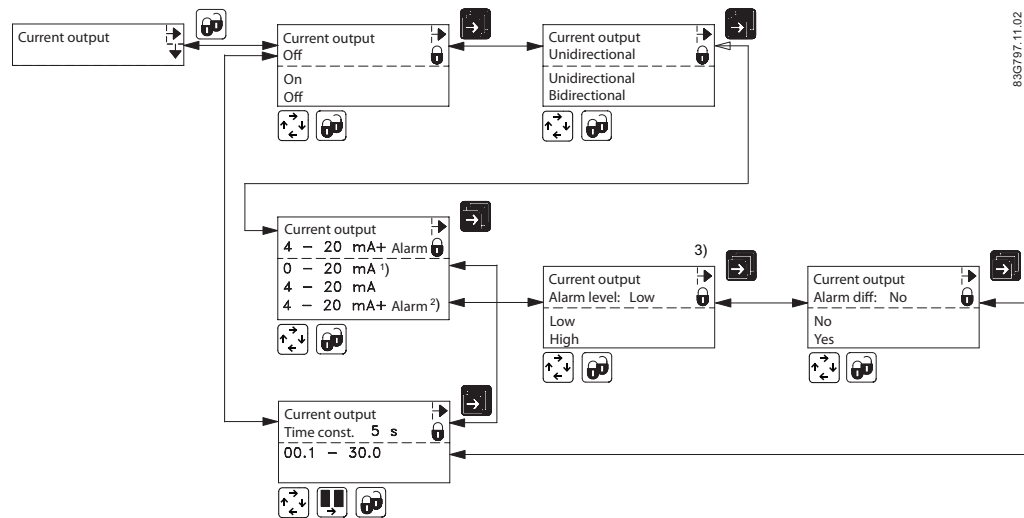

836797.11.02

- 1) If HART communication is installed, it is not possible to set the output for 0-20 mA (even though the option is visible in the display). This is due to the fact that HART does not work if the output falls below 2-3 mA.
- 2) 4-20 mA + Alarm is the default setting for MAG 6000 I. For all other variants, the default setting is 4-20 mA.
- 3) For MAG 6000 I only: The controlling of alarm levels does not recognize if the jumper is mounted for passive output. Do not combine differentiation and low alarm level together with passive output. The output will try to pull down the level to 1.3 mA at fatal errors which is not possible for passive output.

## B.4 Digital output - pulse

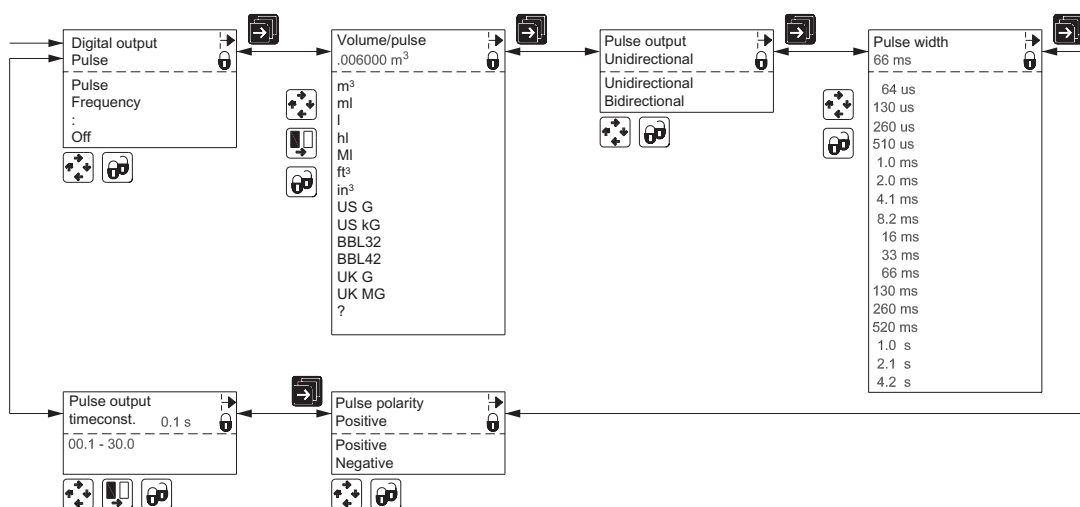

836798.13.02

### B.5 Digital output - frequency

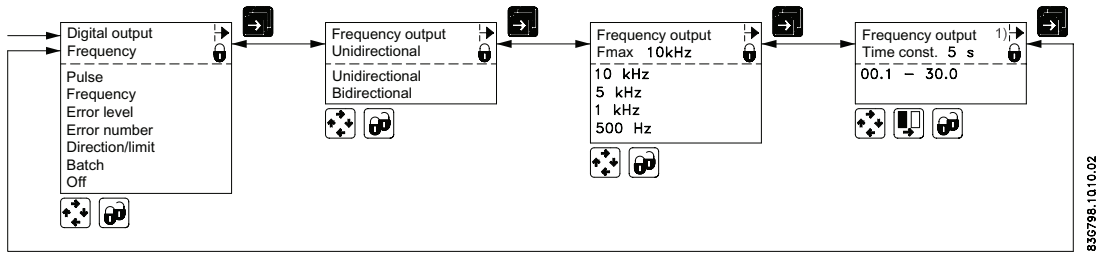

### B.6 Digital output / Relay output - Error level

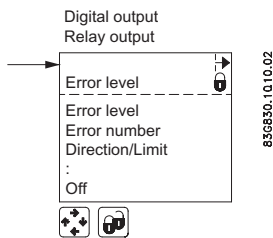

### B.7 Digital output / Relay output - Error number

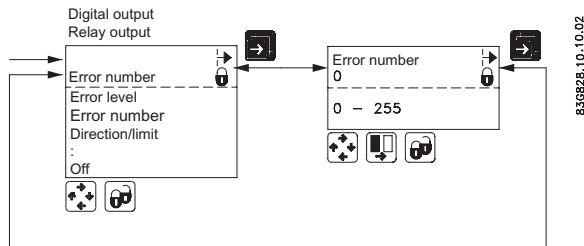

## B.8 Digital output / Relay output - Direction/limit

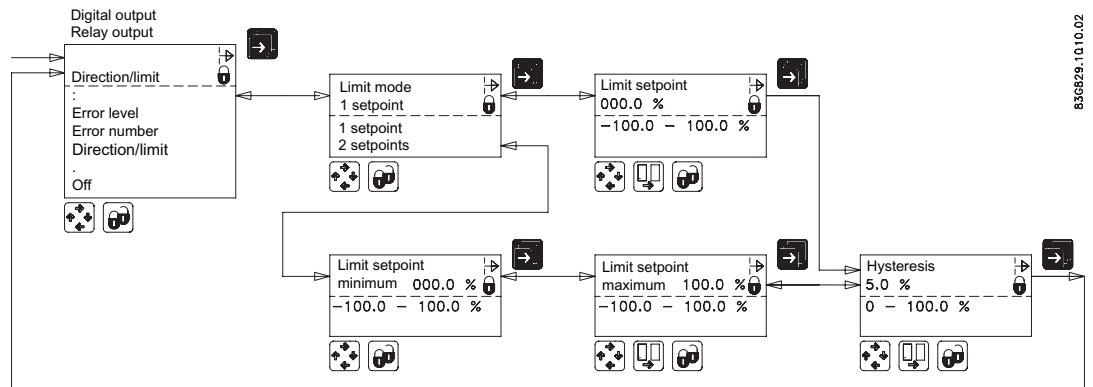

## B.9 Relay output - Cleaning

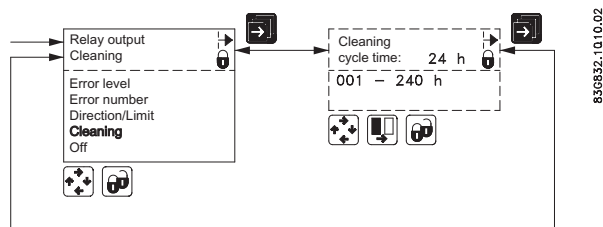

### Note

#### Relay outputs

If cleaning unit is installed, relay outputs must always be used to operate cleaning.

Relay outputs cannot be used for other purposes

## B.10 Digital output / Relay output - Batch

### Note

This menu does not exist on MAG 5000/6000 CT

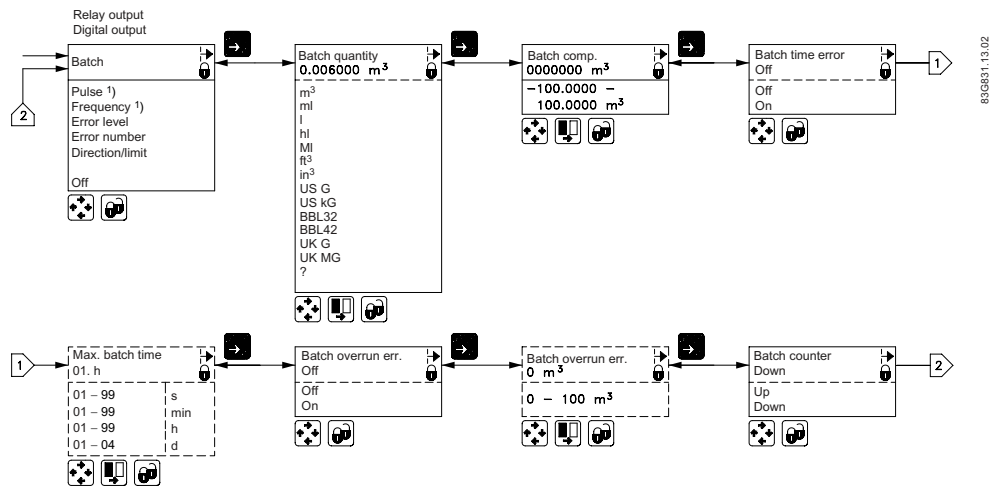

1) Visible only on Digital output.

**Note**

If batch function is chosen on the relay output, the digital output will be turned off if it has been set up for pulse, frequency or batch.

If digital output is set up for pulse, frequency or batch, then the relay output will be turned off if it has been set up for batch.

## B.11 External input

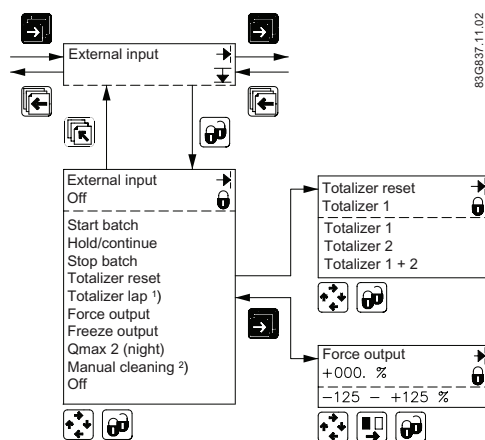

- 1) The value showing totalizer 1 on the display is frozen for as long as the digital output is activated. However, totalizer 1 continues counting, and when the digital input is released, the value on the display again follows totalizer 1.
- 2) MAG 6000 I cannot be equipped with cleaning unit. The cleaning option for relay output is however possible. When selecting function for MAG 6000 I relay output, the relay output has the same behavior as if cleaning unit was installed.

The relay output of the transmitter determines when the relay is on by applying voltage for approximately 60 seconds. The metering is resumed after another 60 seconds when the cycle is complete. (The display is locked during this time). The time cycle can be set at 1 to 240 hours. If the cycle is set at for example three hours, the transmitter will be active every three hours.

## B.12 Sensor characteristics

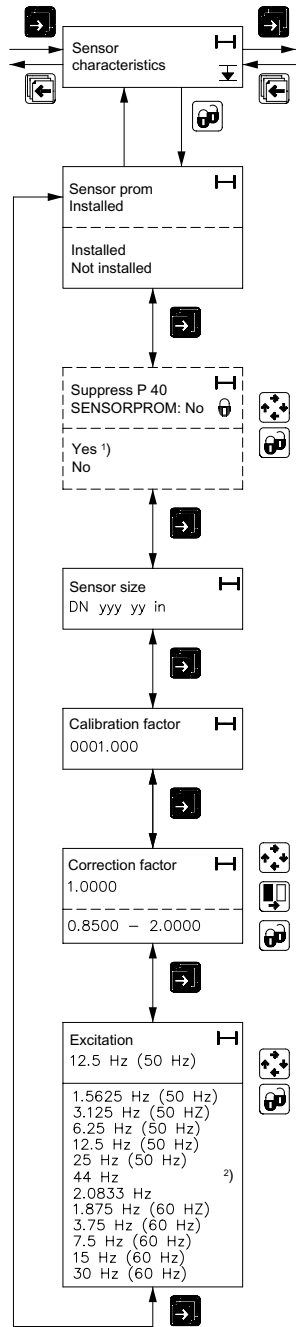

- 1) Error status (level or number) on an output is updated only at the time the error status changes (occurs or disappears). If P40 is suppressed after it has been detected (at power up), the output does not change state. In this case the power must be switched off/on to suppress the P40 error on the output.
- 2) The frequency can be set to 44 Hz in the MAG 6000 SV transmitter only.



## B.13 Reset mode

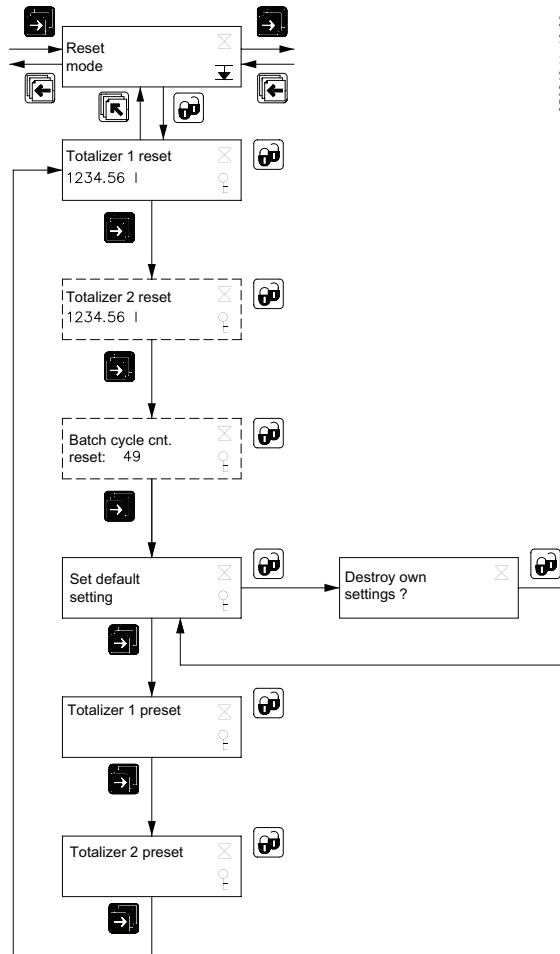

83C840.11\_10.02

B.14 Reset mode - MAG 6000 SV

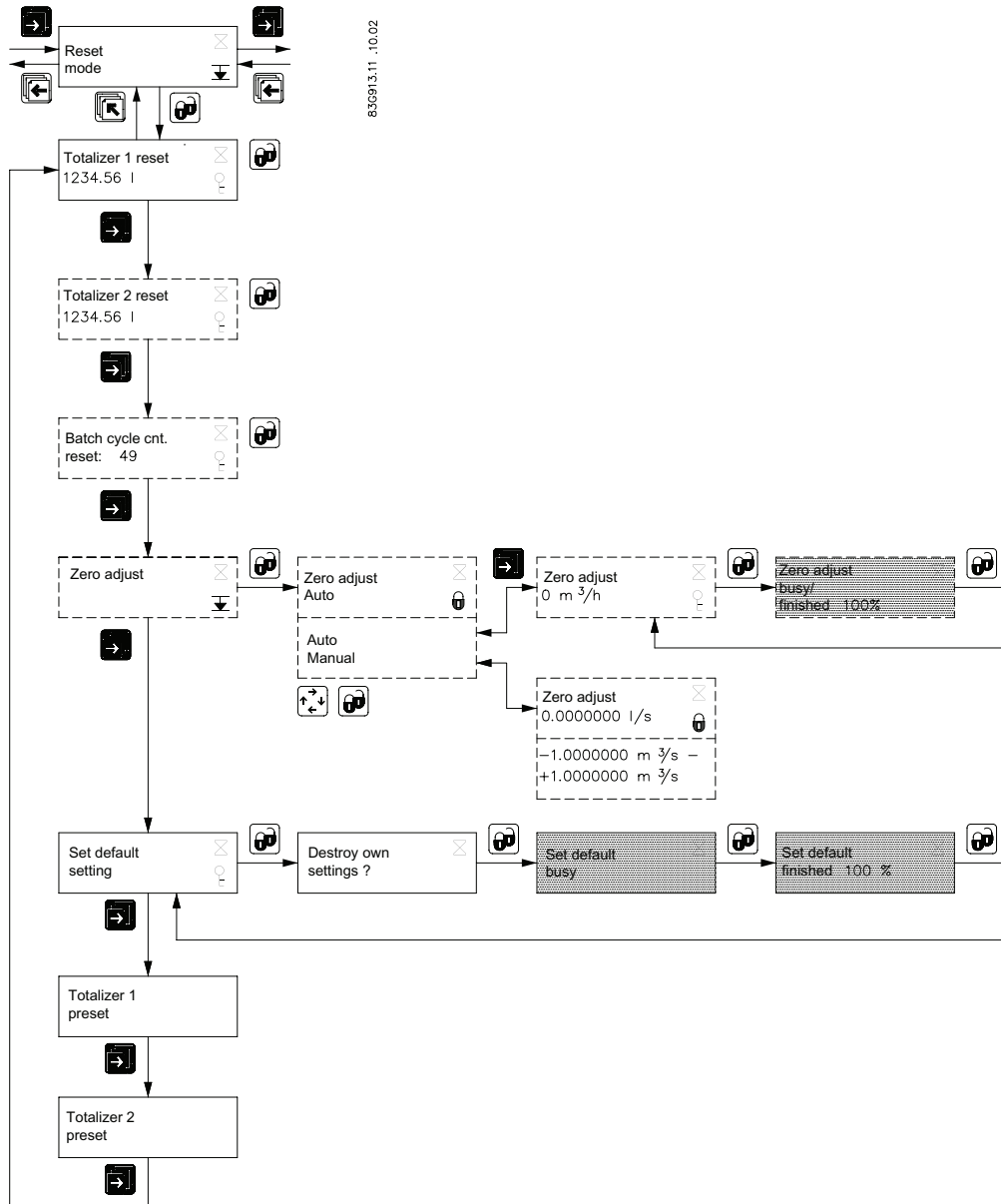

## B.15 Service mode

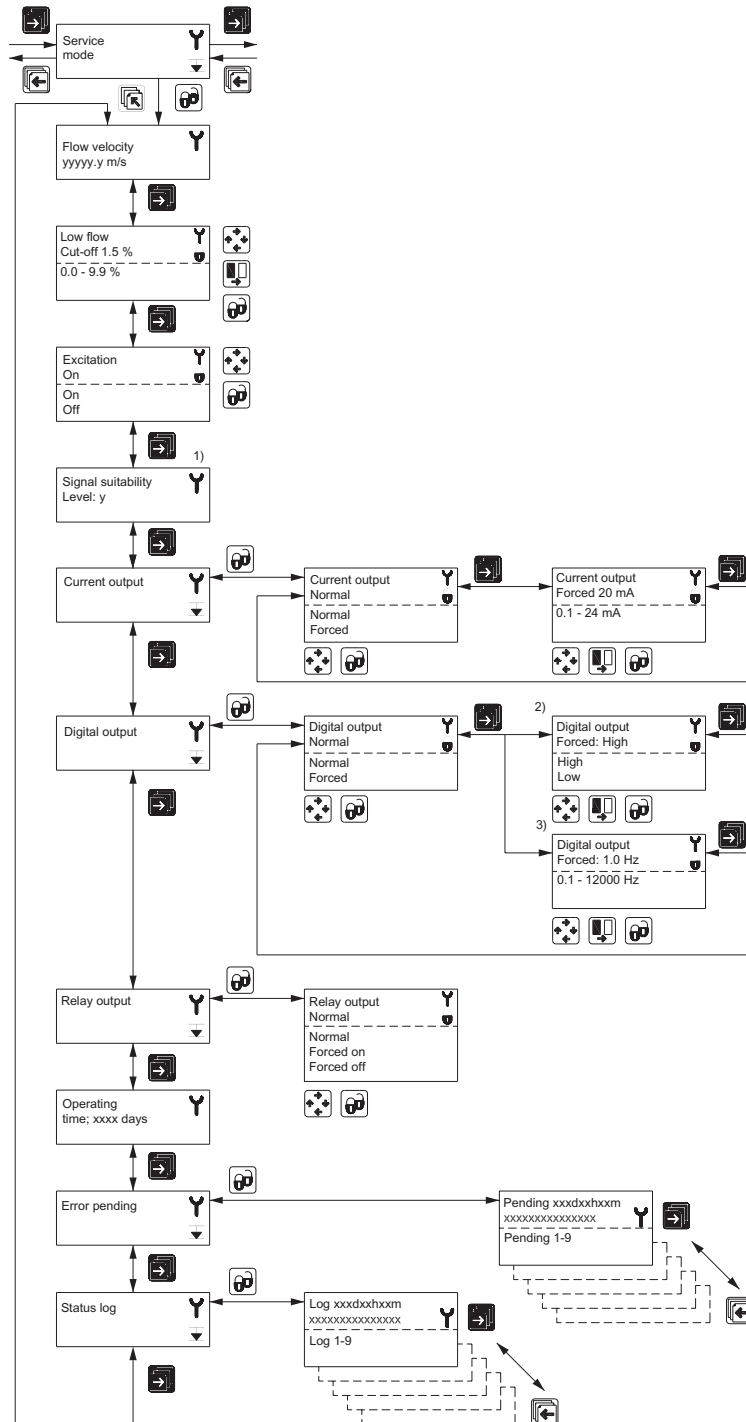

- 1) Signal suitability is a level from 0 to 9 of the electrode measured voltage. Level 0 is equal to the limit value that is set for empty pipe error detection, and level 9 is the best signal measured.
- 2) If digital output is set to pulse (standard).
- 3) If digital output is set to frequency.

## B.16 Operator menu setup

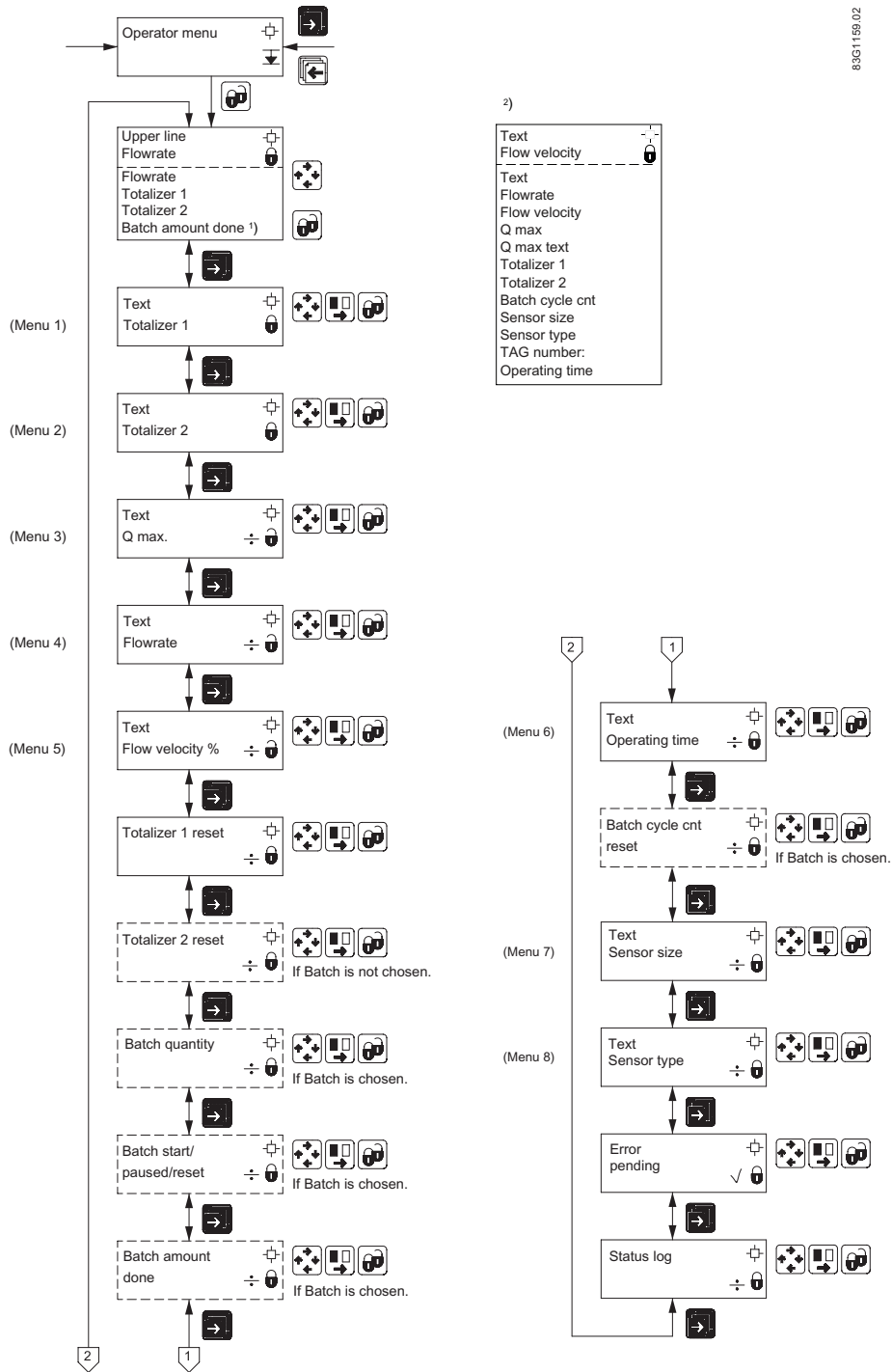

- 1) When selecting Batch amount for upper line, the upper line is initially blank. The amount done may not appear until the batch is started.
- 2) 'Text' means that the text for the chosen measured value is shown. For example, if text is chosen in line 2 and flow velocity is chosen in line 3, the text "Flow velocity" is shown in line 2 and the measured flow velocity is shown in line 3.

## B.17 Product identity

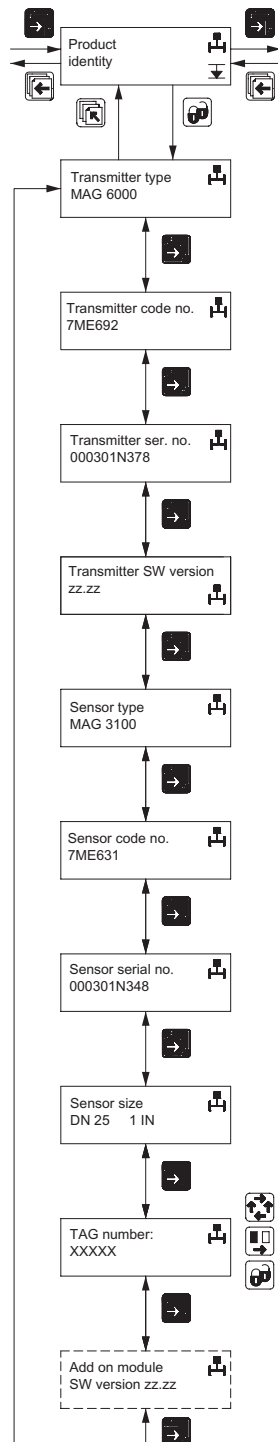

836838.1.11.02

## B.18 Add-on communication module

### Example: HART

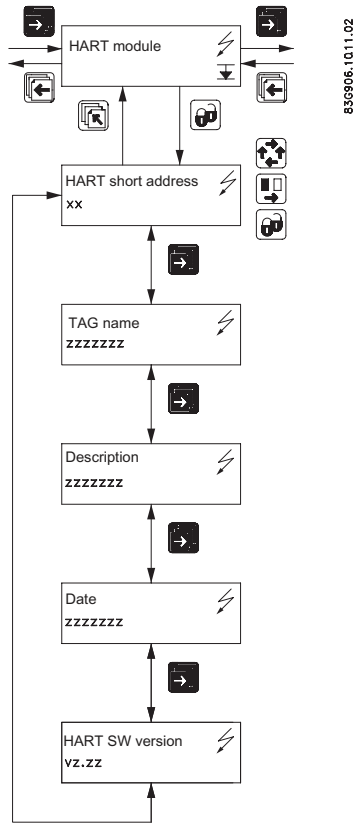

#### Note

Burst mode is not available with HART communication

## B.19 Change password

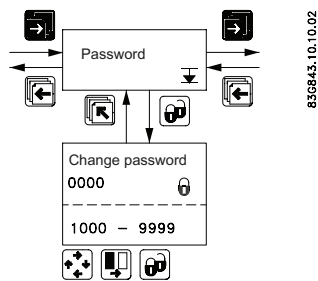

# Factory settings

## C.1 Transmitter factory settings

The factory settings shown on the following pages apply to MAG 5000/6000 as well as MAG 6000 I.

### Note

<sup>1)</sup> Due to legal requirements the only units available for MAG 5000/6000 CT are m<sup>3</sup> and m<sup>3</sup>/h.

Menu item	Parameter	Factory settings	Options	More info
<b>Password</b>	Password	1000	1000 to 9999	Changing password (Page 44)
<b>Basic settings</b>	Flow direction	Positive	Positive, negative	Changing basic settings (Page 44)
	Q <sub>max</sub>	Sensor size dependent	Sensor size dependent	
	• <i>volume unit</i> <sup>1)</sup>	<i>Sensor size dependent</i>	<i>m<sup>3</sup>, ml, l, hl, MI, ft<sup>3</sup>, in<sup>3</sup>, US G, US kG, BBL32, BBL42, UK G, UK MG, ? (customer unit)</i>	
	• <i>time unit</i>	<i>Sensor size dependent</i>	<i>Sec., min., hour, day, ? (customer unit)</i>	
	Totalizer 1	Forward	Forward, reverse, net	
	• <i>Totalizer 1 unit</i> <sup>1)</sup>	<i>Sensor size dependent</i>	<i>m<sup>3</sup>, ml, l, hl, MI, ft<sup>3</sup>, in<sup>3</sup>, US G, US kG, BBL32, BBL42, UK G, UK MG, ? (customer unit)</i>	
	Totalizer 2	Reverse	Forward, reverse, net	
	• <i>Totalizer 2 unit</i> <sup>1)</sup>	<i>Sensor size dependent</i>	<i>m<sup>3</sup>, ml, l, hl, MI, ft<sup>3</sup>, in<sup>3</sup>, US G, US kG, BBL32, BBL42, UK G, UK MG, ? (customer unit)</i>	
	Low flow cut-off	1.5%	0 to 9.9%	
	Empty pipe	Off	On, Off	
	Velocity unit	m/s	m, mm, cm, dm, ft, in per s, min, h, d, ? (customer unit)	
Error level	Warning	Fatal, permanent, warning		

Factory settings

C.1 Transmitter factory settings

Menu item	Parameter	Factory settings	Options	More info
Output	Current output	Off for MAG5000/6000	On/off, Unidirectional/bidirectional, 0 to 20 mA/4 to 20 mA/4 to 20 mA + Alarm	Output settings (Page 51)
	• Alarm level	Low	High/Low	
	• Alarm diff.	No	Yes/No	
	• Time constant	5 s	0.1 to 30 s	
	Digital output	Pulse	Error, direction/limit, batch, frequency, pulse, error number, off	Digital output - pulse (Page 83)
	Relay output	Error level	Error, direction/limit, cleaning, error number, off	Digital output / Relay output - Error level (Page 84)
	Direction/limit switch	Off	1 setpoint, 2 setpoints	Digital output / Relay output - Direction/limit (Page 85)
	• Setpoints	0%	-100 to +100%	
	• Hysteresis	5%	0.0 to 100%	
	Batch	Off		Digital output / Relay output - Batch (Page 85)
	• Batch quantity	0	Sensor size dependent	
	• Batch compensation	0	-100 to +100 m <sup>3</sup>	
	• Batch counter	Down	Up, down	
	Frequency	Off	500 Hz, 1 kHz, 5 kHz, 10 kHz	Digital output - frequency (Page 84)
	• Time constant	5 s	0.1 to 30 s	
	Pulse	On		Digital output - pulse (Page 83)
• Pulse polarity	Positive	Positive, negative		
• Pulse width	66 ms	64 μs, 130 μs, 260 μs, 510 μs, 1.0 ms, 2.0 ms, 4.1 ms, 8.2 ms, 16 ms, 33 ms, 66 ms, 130 ms, 260 ms, 520 ms, 1.0 s, 2.1 s, 4.2 s		
• Volume/pulse	Sensor size dependent	Dimension-dependent		
	• Time constant	0.1 s	0.1 to 30 s	
External input	External input	Off	Batch, reset totalizer, freeze output, forced output, off	External input (Page 87)
	• Batch	Start	Start, hold/continue, stop, Qmax 2	
Sensor characteristics	Correction factor	1	0.85 to 2.00	Sensor characteristics (Page 88)
Language	Language	English	English, German, French, Danish, Swedish, Finnish, Spanish, Russian, Italian, Portuguese, Polish	Changing language (Page 48)



Menu item	Parameter	Factory settings	Options	More info
Operator menu	Primary field	Flow rate	Flow rate, Totalizer 1, Totalizer 2	Changing operator menu setup (Page 47)
	Title/subtitle lines	Flow rate	Flow rate, Flow velocity, Qmax, Totalizer 1, Totalizer 2, Totalizer 1 reset, Totalizer 2 reset, Batch start/paused/stop, Batch cycle counter, Batch cycle counter reset, Sensor size, Sensor type, Error pending, Status log, Tag No.	

### See also

Change password (Page 94)

## C.2 50 Hz Dimension dependent Qmax

Table C-1 MAG 1100, MAG 1100 F, MAG 3100, MAG 3100 P and MAG 5100 W with M20 cable glands

DN	Q <sub>max</sub> *					unit
	Factory setting	MAG 5100 W (Order no. 7ME6520)		MAG 1100, MAG 1100 F, 5100 W (Order no. 7ME6580), MAG 3100, 3100 P		
mm (inch)		min.	max.	min.	max.	
2 (1/12)	30	-	-	3.903623	156.1448	l/h
3 (1/8)	70	-	-	6.361726	254.469	l/h
6 (1/4)	300	-	-	25.44691	1017.876	l/h
10 (3/8)	900	-	-	70.68584	2827.433	l/h
15 (1/2)	2000	-	-	159.0432	6361.725	l/h
25 (1)	5000	441.7865	17671.45	441.7865	17671.45	l/h
40 (1 1/2)	12	1.130974	45.23893	1.130974	45.23893	m <sup>3</sup> /h
50 (2)	20	1.574527	62.98107	1.767146	70.68583	m <sup>3</sup> /h
65 (2 1/2)	30	2.499681	99.98723	2.986477	119.459	m <sup>3</sup> /h
80 (3)	50	4.003646	160.1458	4.523894	180.9557	m <sup>3</sup> /h
100(4)	120	6.252163	250.0864	7.068584	282.7433	m <sup>3</sup> /h
125 (5)	180	10.00647	400.2585	11.04467	441.7864	m <sup>3</sup> /h
150 (6)	250	15.74527	629.8107	15.90432	636.1725	m <sup>3</sup> /h
200(8)	400	24.93797	997.5184	28.27434	1130.973	m <sup>3</sup> /h
250(10)	700	40.00377	1600.15	44.17865	1767.145	m <sup>3</sup> /h
300 (12)	1000	62.50395	2500.157	63.61726	254469	m <sup>3</sup> /h
350 (14)	1200	86.59015	3463.605	86.59015	3463.605	m <sup>3</sup> /h
400 (16)	1800	113.0974	4523.893	113.0974	4523.893	m <sup>3</sup> /h
450 (18)	2000	143.1389	5725.552	143.1389	5725.552	m <sup>3</sup> /h
500 (20)	3000	176.7146	7068.583	176.7146	7068.583	m <sup>3</sup> /h
600 (24)	4000	254.4691	10178.76	254.4691	10178.76	m <sup>3</sup> /h
700 (28)	4500	346.3606	13854.42	346.3606	13854.42	m <sup>3</sup> /h
750 (30)	5000	397.6079	15904.31	397.6079	15904.31	m <sup>3</sup> /h

Factory settings

C.3 60 Hz Dimension dependent Qmax

DN	Q <sub>max</sub> *					
	Factory setting	MAG 5100 W (Order no. 7ME6520)		MAG 1100, MAG 1100 F, 5100 W (Order no. 7ME6580), MAG 3100, 3100 P		unit
mm (inch)		min.	max.	min.	max.	
800 (32)	7000	452.3894	18095,57	452.3894	18095.57	m <sup>3</sup> /h
900 (36)	9000	572.5553	22902,21	572.5553	22902.21	m <sup>3</sup> /h
1000 (40)	12000	706.8584	28274.33	706.8584	28274.33	m <sup>3</sup> /h
1050 (42)	12000	706.8584	28274.33	706.8584	28274.33	m <sup>3</sup> /h
1100 (44)	14000	855.986	34211.94	855.2986	3421194	m <sup>3</sup> /h
1200 (48)	15000	1017.877	40715.04	1017.877	40715.04	m <sup>3</sup> /h
1400 (54)	25000	-	-	1385.443	55417.69	m <sup>3</sup> /h
1500 (60)	30000	-	-	1590.432	63617.25	m <sup>3</sup> /h
1600 (66)	35000	-	-	1809.558	72382.29	m <sup>3</sup> /h
1800 (72)	40000	-	-	2290.222	91608.84	m <sup>3</sup> /h
2000 (78)	45000	-	-	2827.434	113097.3	m <sup>3</sup> /h
2200 (90)	50000	-	-	3421,195	136847.7	m <sup>3</sup> /h
2400 (96)	55000	-	-	4071.505	162860.1	m <sup>3</sup> /h
2600 (102)	60000	-	-	4778.363	191134.4	m <sup>3</sup> /h
280 (114)	65000	-	-	5541.77	221670.7	m <sup>3</sup> /h
3000 (120)	70000	-	-	6361.726	254469	m <sup>3</sup> /h

\* The min. and max. amount values show mathematical values and do not indicate measurement accuracy

### C.3 60 Hz Dimension dependent Qmax

Table C-2 MAG 1100, MAG 1100 F, MAG 3100, MAG 3100 P and MAG 5100 W with ½" NPT cable glands

DN	Q <sub>max</sub> *					
	Factory setting*	MAG 5100 W (Order no. 7ME6520)		MAG 1100, MAG 1100 F, 5100 W (Order no. 7ME6580), MAG 3100, 3100 P		unit
mm (inch)		min.	max.	min.	max.	
2 (1/12)	0.14	-	-	0.01718714	0.6874852	US GPM
3 (1/8)	0.31	-	-	0.02800984	1.120393	US GPM
6 (1/4)	1.4	-	-	0.1120394	4.481573	US GPM
10 (3/8)	4	-	-	0.3112204	12.44881	US GPM
15 (1/2)	9	-	-	0.7002459	28.0	US GPM
25 (1)	23	1.945128	77.80509	1.945128	77.80509	US GPM
40 (1 1/2)	53	4.979526	199.181	4.979526	199.181	US GPM
50 (2)	89	6.932434	277.2973	7.78051	311.2203	US GPM
65 (2 1/2)	133	11.00577	440.2305	13.14907	525.9624	US GPM
80 (3)	221	17.62753	705.1008	19.91811	796.7241	US GPM

DN	Q <sub>max</sub>					unit
	Factory setting*	MAG 5100 W (Order no. 7ME6520)		MAG 1100, MAG 1100 F, 5100 W (Order no. 7ME6580), MAG 3100, 3100 P		
mm (inch)		min.	max.	min.	max.	
100(4)	529	27.52745	1101.097	31.12204	1244.881	US GPM
125 (5)	793	44.05714	1762.285	48.62819	1945.127	US GPM
150 (6)	1101	69.32434	2772.973	70.02459	2800.984	US GPM
200 (8)	1762	109.7986	4391.941	124.48819	4979.525	US GPM
250 (10)	3083	176.1313	7045.251	194.5128	7780.507	US GPM
300 (12)	4403	275.1967	11007.86	280.0984	11203.93	US GPM
350 (14)	5284	381.245	15249.79	381.245	15249.79	US GPM
400 (16)	7926	497.9526	19918.1	497.9526	19918.1	US GPM
450 (18)	8806	630.2213	25208.84	630.2213	25208.84	US GPM
500 (20)	13209	778.051	31122.03	778.051	31122.03	US GPM
600 (24)	17612	1120.394	44815.73	1120.394	44815.73	US GPM
700 (28)	19813	1524.98	60999.19	1524.98	60999.19	US GPM
750 (30)	22015	1750.615	70024.58	1750.615	70024.58	US GPM
800 (32)	3082	1991.811	79672.4	1991.811	79672.41	US GPM
900 (36)	39626	2520.885	100835.3	2520.885	100835.3	US GPM
1000 (40)	52835	3112.204	124488.1	3112.204	124488.1	US GPM
1050 (42)	52835	3112.204	137248.1	3112.204	124488.1	US GPM
1100 (44)	61641	3765.767	150630.6	3765.767	150630.6	US GPM
1200 (48)	66044	4481.574	179262.9	4481.574	179262.9	US GPM
1400 (54)	110072	-	-	6099.92	243996.7	US GPM
1500 (60)	1320867	-	-	7002.459	280098.3	US GPM
1600 (66)	154101	-	-	7967.242	318689.6	US GPM
1800 (72)	176115	-	-	10083.54	403341.5	US GPM
2000 (78)	198130	-	-	12448.82	497952.5	US GPM
2200 (90)	220144	-	-	15063.07	602522.6	US GPM
2400 (96)	242158	-	-	17926.3	717051.7	US GPM
2600 (102)	264173	-	-	21038.5	841539.8	US GPM
2800 (114)	286187	-	-	24399.68	975987	US GPM
3000 (120)	308201	-	-	28009.84	1120393	US GPM

\* Factory setting sets Qmax to a metric unit (see previous table). The values here are converted to rounded off US GPM.

## C.4 50 Hz Dimension dependent volume/pulse and batch

Table C-3 MAG 1100, MAG 1100 F, MAG 3100, MAG 3100 P and MAG 5100 W with ½" NPT cable glands

DN	Volume/pulse or batch quantity*				Factory setting		
	MAG 5100 W (Order no. 7ME6520)		MAG 1100, MAG 1100 F, 5100 W (Order no. 7ME6580), MAG 3100, 3100 P		Volume/pulse & batch amount	Pulse & batch unit	Totalizer unit
mm (inch)	min.	max.	min.	max.			
2 (1/12)	-	-	3.61466 µl	94.75103 l	0.1	ml	ml
3 (1/8)	-	-	5.890487 µl	154.4155 l	0.1	ml	ml
6 (1/4)	-	-	23.56195 µl	617.6622 l	1	l	l
10 (3/8)	-	-	65.44985 µl	1.715728 m³	1	l	l
15 (1/2)	-	-	147.2622 µl	3.860389 m³	1	l	l
25 (1)	409.0616 µl	10.7233 m³	409.0616 µl	10.7233 m³	10	l	l**
40 (1 1/2)	1.047198 ml	27.45165 m³	1.047198 ml	27.45165 m³	10	l	l**
50 (2)	1.457896 ml	38.21785 m³	1.636247 ml	42.89321 m³	10	l	l**
65 (2 1/2)	2.31452 ml	60.67373 m³	2.765257 ml	72.48952 m³	100	l	l**
80 (3)	3.70708 ml	97.17886 m³	4.188791 ml	109.8066 m³	100	l	l**
100(4)	5.789039 ml	151.7561 m³	6.544985 ml	171.5728 m³	100	l	l**
125 (5)	9.265244 ml	242.8828 m³	10.22654 ml	268.0825 m³	100	l	m³
150 (6)	14.57896 ml	382.1785 m³	14.72622 ml	386.0389 m³	100	l	m³
200 (8)	23.09071 ml	605.309 m³	26.17994 ml	686.2913 m³	1	m³	m³
250 (10)	37.04053 ml	970.995 m³	40.90616 ml	1072.33 m³	1	m³	m³
300 (12)	57.87403 ml	1517.132 m³	58.90487 ml	1544.155 m³	1	m³	m³
350 (14)	80.17607 ml	2101.767 m³	80.17607 ml	210.7671 m³	1	m³	m³
400 (16)	104.7198 ml	2745.165 m³	104.7198 ml	2745.165 m³	1	m³	m³
450 (18)	132.536 ml	3474.35 m³	132.536 ml	3474.35 m³	1	m³	m³
500 (20)	163.6247 ml	4289.321 m³	163.6247 ml	4289.321 m³	10	m³	m³
600 (24)	235.6195 ml	6176.622 m³	235.6195 ml	6176.622 m³	10	m³	m³
700 (28)	320.7043 ml	8407.069 m³	320.7143 ml	8407.069 m³	10	m³	m³
750 (30)	368.1554 ml	9650.972 m³	368.1554 ml	9650.972 m³	10	m³	m³
800 (32)	418.8791 ml	10980.66 m³	418.8791 ml	10980.66 m³	10	m³	m³
900 (36)	530.1438 ml	13897.4 m³	530.1438 ml	13897.4 m³	10	m³	m³
1000 (40)	654.4985 ml	17157.28 m³	654.4985 ml	17157.28 m³	10	m³	m³
1050 (42)	654.4985 ml	17157.28 m³	654.4985 ml	17157.28 m³	10	m³	m³
1100 (44)	79.94321 ml	20760.31 m³	791.9432 ml	20760.31 m³	10	m³	m³
1200 (48)	942.4778 ml	24706.48 m³	942.4778 ml	24706.48 m³	10	m³	m³
1400 (54)	-	-	1.282817 l	33628.27 m³	10	m³	m³
1500 (60)	-	-	1.472622 l	38603.89 m³	10	m³	m³
1600 (66)	-	-	1.675517 l	43922.64 m³	10	m³	m³
1800 (72)	-	-	2.120576 l	55589.6 m³	10	m³	m³
2000 (78)	-	-	2.617994 l	68629.13 m³	10	m³	m³
2200 (90)	-	-	3.167773 l	83041.25 m³	10	m³	m³

## C.5 60 Hz Dimension dependent volume/pulse and batch

DN	Volume/pulse or batch quantity*				Factory setting		
	MAG 5100 W (Order no. 7ME6520)		MAG 1100, MAG 1100 F, 5100 W (Order no. 7ME6580), MAG 3100, 3100 P		Volume/pulse & batch amount	Pulse & batch unit	Totalizer unit
mm (inch)	min.	max.	min.	max.			
2400 (96)	-	-	3.769912 l	98825.9 m <sup>3</sup>	10	m <sup>3</sup>	m <sup>3</sup>
2600 (102)	-	-	4.4241 l	115983. m <sup>3</sup>	10	m <sup>3</sup>	m <sup>3</sup>
2800 (114)	-	-	5.131268 l	134513.1 m <sup>3</sup>	10	m <sup>3</sup>	m <sup>3</sup>
3000 (120)	-	-	5.890487 l	154415.5 m <sup>3</sup>	10	m <sup>3</sup>	m <sup>3</sup>

\* The min. and max. amount values show mathematical values and do not indicate measurement accuracy.

\*\* For CT devices the totalizer 1 unit is in m<sup>3</sup>

## C.5 60 Hz Dimension dependent volume/pulse and batch

Table C-4 MAG 1100, MAG 1100 F, MAG 3100, MAG 3100 P and MAG 5100 W with ½" NPT cable glands

DN	Volume/pulse or batch quantity			
	MAG 5100 W (Order no. 7ME6520)		MAG 1100, MAG 1100 F, 5100 W (Order no. 7ME6580), MAG 3100, 3100 P	
mm (inch)	US G min.	US G max.	US G min.	US G max.
2 (1/12)	-	-	0.00000095484069	25.03057
3 (1/8)	-	-	0.000001556102	40.79227
6 (1/4)	-	-	0.000006224408	163.1691
10 (3/8)	-	-	0.00001729003	453.2475
15 (1/2)	-	-	0.00003890255	1019.806
25 (1)	0.0001080627	2832.796	0.0001080627	2832.796
40 (1 1/2)	0.0002766404	7251.96	0.0002766404	7251.96
50 (2)	0.0003851353	10096.08	0.0004322506	11331.18
65 (2 1/2)	0.0006114314	16028.3	0.0007305034	19149.7
80 (3)	0.0009793068	25671.93	0.001106562	29007.84
100(4)	0.001529303	40089.74	0.001729003	45324.75
125 (5)	0.002447619	64162.85	0.002701566	70819.92
150 (6)	0.003851353	100960.8	0.003890255	101980.6
200 (8)	0.00609992	159905.7	0.006916009	181299
250 (10)	0.009785071	256509.7	0.01080627	283279.6
300 (12)	0.01528871	400784.1	0.01556102	407922.7
350 (14)	0.02118028	555228.2	0.02118028	555228.2
400 (16)	0.02766404	725196	0.02766404	725196
450 (18)	0.0350123	917826.2	0.0350123	917826.2
500 (20)	0.04322506	1133118	0.04322506	1133118
600 (24)	0.06224408	1631691	0.06224408	1631691
700 (28)	0.0847211	2220912	0.0847211	2220912

Factory settings

C.5 60 Hz Dimension dependent volume/pulse and batch

DN	Volume/pulse or batch quantity			
	MAG 5100 W (Order no. 7ME6520)		MAG 1100, MAG 1100 F, 5100 W (Order no. 7ME6580), MAG 3100, 3100 P	
mm (inch)	US G min.	US G max.	US G min.	US G max.
750 (30)	0.09725637	2549517	0.09725637	2549517
800 (32)	0.1106562	2900784	0.1106562	2900784
900 (36)	0.1400492	3671304	0.1400492	3671304
1000 (40)	0.1729003	4532475	0.1729003	4532475
1050 (42)	0.1729003	4532475	0.1729003	4532475
1100 (44)	0.2092093	5484294	0.2092093	5484294
1200 (48)	0.2489763	6526764	0.2489763	6526764
1400 (54)	-	-	0.3388844	8883651
1500 (60)	-	-	0.3890255	10198060
1600 (66)	-	-	0.4426246	11603130
1800 (72)	-	-	0.5601967	14685210
2000 (78)	-	-	0.6916009	18129900
2200 (90)			0.836837	21937170
2400 (96)			0.995906	26107050
2600 (102)			1.168806	30639530
2800 (114)			1.355538	35534600
3000 (120)			1.556102	40792270

# Product documentation and support

## D.1 Product documentation

Process instrumentation product documentation is available in the following formats:

- Certificates (<http://www.siemens.com/processinstrumentation/certificates>)
- Downloads (firmware, EDDs, software) (<http://www.siemens.com/processinstrumentation/downloads>)
- Catalog and catalog sheets (<http://www.siemens.com/processinstrumentation/catalogs>)
- Manuals (<http://www.siemens.com/processinstrumentation/documentation>)  
You have the option to show, open, save, or configure the manual.
  - "Display": Open the manual in HTML5 format
  - "Configure": Register and configure the documentation specific to your plant
  - "Download": Open or save the manual in PDF format
  - "Download as html5, only PC": Open or save the manual in the HTML5 view on your PC

You can also find manuals with the Mobile app at Industry Online Support (<https://support.industry.siemens.com/cs/ww/en/sc/2067>). Download the app to your mobile device and scan the device QR code.

### Product documentation by serial number

Using the PIA Life Cycle Portal, you can access the serial number-specific product information including technical specifications, spare parts, calibration data, or factory certificates.

#### Entering a serial number

1. Open the PIA Life Cycle Portal (<https://www.pia-portal.automation.siemens.com>).
2. Select the desired language.
3. Enter the serial number of your device. The product documentation relevant for your device is displayed and can be downloaded.

To display factory certificates, if available, log in to the PIA Life Cycle Portal using your login or register.

#### Scanning a QR code

1. Scan the QR code on your device with a mobile device.
2. Click "PIA Portal".

To display factory certificates, if available, log in to the PIA Life Cycle Portal using your login or register.

## D.2 Technical support

### Technical support

If this documentation does not completely answer your technical questions, you can enter a Support Request (<http://www.siemens.com/automation/support-request>).

Additional information on our technical support can be found at Technical Support (<http://www.siemens.com/automation/csi/service>).

### Service & support on the Internet

In addition to our technical support, Siemens offers comprehensive online services at Service & Support (<http://www.siemens.com/automation/service&support>).

### Contact

If you have further questions about the device, contact your local Siemens representative at Personal Contact (<http://www.automation.siemens.com/partner>).

To find the contact for your product, go to "all products and branches" and select "Products & Services > Industrial automation > Process instrumentation".

Contact address for business unit:

Siemens AG  
Digital Industries  
Process Automation  
Östliche Rheinbrückenstr. 50  
76187 Karlsruhe, Germany



# Index

## A

Add-on module, 15  
Add-on modules  
    Electrical connection: Add-on modules, 40  
Alarm differentiation, 51  
Alarm level, 51

## C

Catalog  
    catalog sheets, 103  
Certificates, 103  
Communication module, (See Add-on module)  
Compliance, 11  
Customer Support, (Refer to Technical support)  
Customer Support Hotline, 58

## D

Device  
    Inspection, 18  
Diagnostic functions, 61  
Downloads, 103

## E

Electrical connection, 40  
    Safety instructions, 37  
Error handling, 61

## H

Hotline, 58, (Refer to Support request)

## I

Installation  
    Indoor/outdoor, 21  
Internet  
    Contact person, 59  
    Support, 58

## L

Laws and directives, 11

## M

Mains supply, 37  
Maintenance, 57  
Manuals, 103  
Menu structure, 51

## R

Repair, 57  
Return procedure, 59

## S

Safety, 11  
    Instrument safety standards, 11  
Safety instructions  
    Electrical connection, 37  
Scope of delivery, 8  
Service, 57, 58, 104  
Service and support  
    Internet, 104  
Settings, 51  
Support, 58, 104  
Support request, 104  
System components, 15

## T

Technical support, 104  
    partner, 104  
    personal contact, 104  
Troubleshooting, 64

## W

Warranty, 9

