

FR - Guide de démarrage rapide  
GB - Quick start guide  
DE - Schnellstart-Anleitung  
IT - Guida di utilizzo rapido  
ES - Guía de inicio rápido

# C.A 1821

# C.A 1822

# C.A 1823

---



**Thermomètres**  
**Thermometers**  
**Thermometer**  
**Termometri**  
**Termómetros**

ICS Schneider Messtechnik GmbH  
Briesestraße 59  
D-16562 Hohen Neuendorf / OT Bergfelde

Tel.: 03303 / 50 40 66  
Fax: 03303 / 50 40 68

info@ics-schneider.de  
www.ics-schneider.de

<b>English</b> .....	<b>8</b>
<b>Deutsch</b> .....	<b>14</b>
<b>Italiano</b> .....	<b>20</b>
<b>Español</b> .....	<b>26</b>

Vous venez d'acquérir un **thermomètre à thermocouple C.A 1821 ou C.A 1822, ou un thermomètre à sonde résistive C.A 1823** et nous vous remercions de votre confiance.

Pour obtenir le meilleur service de votre appareil :

- **lisez** attentivement la notice de fonctionnement,
- **respectez** les précautions d'emploi.



ATTENTION, risque de DANGER ! L'opérateur doit consulter la présente notice à chaque fois que ce symbole de danger est rencontré.



Information ou astuce utile.



Pile.



Aimant.



Le produit est déclaré recyclable suite à une analyse du cycle de vie conformément à la norme ISO14040.



Chauvin Arnoux a étudié cet appareil dans le cadre d'une démarche globale d'Eco-Conception. L'analyse du cycle de vie a permis de maîtriser et d'optimiser les effets de ce produit sur l'environnement. Le produit répond plus précisément à des objectifs de recyclage et de valorisation supérieurs à ceux de la réglementation.



Le marquage CE indique la conformité aux directives européennes, notamment DBT et CEM.



La poubelle barrée signifie que, dans l'Union Européenne, le produit doit faire l'objet d'une collecte sélective conformément à la directive DEEE 2002/96/EC : ce matériel ne doit pas être traité comme un déchet ménager.

## NOTICE DE FONCTIONNEMENT

Rendez-vous sur notre site Internet pour télécharger la notice de fonctionnement de votre appareil :

Allez dans l'onglet **Produits** et effectuez une recherche avec le nom de votre appareil. Une fois l'appareil trouvé, allez sur sa page. La notice de fonctionnement se trouve sur la droite. Téléchargez-la.

# PRÉCAUTIONS D'EMPLOI

Cet appareil est conforme à la norme de sécurité IEC 61010-2-030, pour des tensions de 5 V par rapport à la terre. Le non-respect des consignes de sécurité peut entraîner un risque de choc électrique, de feu, d'explosion, de destruction de l'appareil et des installations.

- L'opérateur et/ou l'autorité responsable doit lire attentivement et avoir une bonne compréhension des différentes précautions d'emploi. Une bonne connaissance et une pleine conscience des risques des dangers électriques est indispensable pour toute utilisation de cet appareil.
- Respectez les conditions d'utilisation, à savoir la température, l'humidité, l'altitude, le degré de pollution et le lieu d'utilisation.
- N'utilisez pas l'appareil s'il semble endommagé, incomplet ou mal fermé.
- Avant chaque utilisation, vérifiez le bon état du boîtier et des accessoires. Tout élément dont l'isolant est détérioré (même partiellement) doit être consigné pour réparation ou pour mise au rebut.
- Ne faites pas de mesure sur des conducteurs nus sous tension. Utilisez un capteur sans contact ou un capteur apportant l'isolation électrique nécessaire.
- Utilisez systématiquement un équipement de protection individuel (EPI), notamment des gants isolants, en cas de doute ou d'incapacité à mesurer les niveaux de tensions sur lequel le capteur de température est branché.
- Toute procédure de dépannage ou de vérification métrologique doit être effectuée par du personnel compétent et agréé.

## SOMMAIRE

<b>1. Première mise en service</b> .....	<b>4</b>
1.1. État de livraison.....	4
1.2. Mise en place des piles .....	4
<b>2. Présentation des appareils</b> .....	<b>5</b>
2.1. C.A 1821 et 1822.....	5
2.2. C.A 1823.....	5
2.3. Touches .....	6
<b>3. Connexion à un PC</b> .....	<b>7</b>
3.1. Obtenir le logiciel Data Logger Transfer.....	7
3.2. Connexion .....	7

# 1. PREMIÈRE MISE EN SERVICE

## 1.1. ÉTAT DE LIVRAISON

Thermomètre à thermocouple C.A 1821 ou C.A 1822, ou thermomètre à sonde résistive C.A 1823

Livré dans une boîte en carton avec :

- trois piles alcaline AA ou LR6,
- un cordon USB-micro USB,
- un guide de démarrage rapide multilingue,
- une fiche de sécurité multilingue,
- un rapport de test,
- une sacoche.

## 1.2. MISE EN PLACE DES PILES

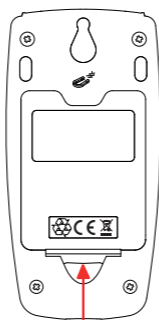

- Appuyez sur la languette de la trappe à pile et soulevez-là.
- Retirez la trappe à pile.
- Placez les nouvelles piles en respectant la polarité.
- Refermez la trappe à pile en vous assurant de sa fermeture complète et correcte.

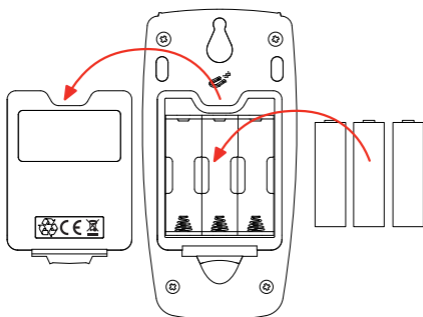

## 2. PRÉSENTATION DES APPAREILS



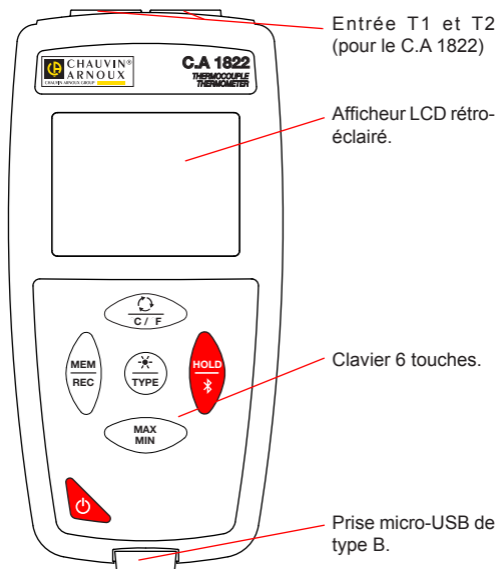



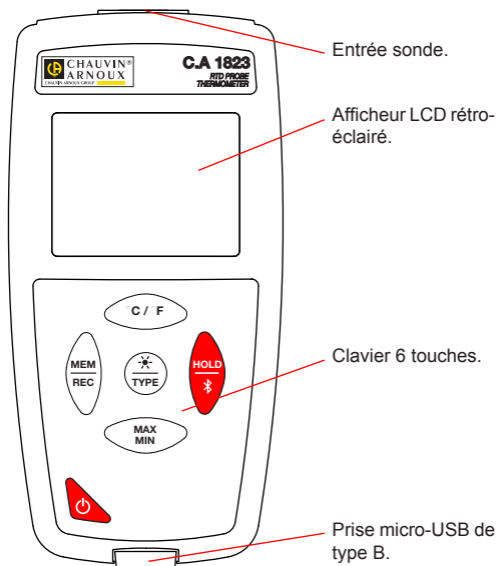

### 2.1. C.A 1821 ET 1822



### 2.2. C.A 1823



## 2.3. TOUCHES

Touche	Fonction
	<ul style="list-style-type: none"> <li>■ Un appui long sur la touche  permet d'allumer l'appareil.</li> <li>■ De même, un appui long sur la touche  permet d'éteindre l'appareil. Mais il n'est pas possible d'éteindre l'appareil lorsqu'il est en mode enregistreur et qu'il est en cours d'enregistrement.</li> </ul>
	<p>Pour le C.A 1821 et le C.A 1823</p> <ul style="list-style-type: none"> <li>■ La touche °C/°F permet d'afficher la mesure soit en °C soit en °F.</li> </ul> <p>Pour le C.A 1822</p> <ul style="list-style-type: none"> <li>■ Un appui court sur la touche  permet d'afficher sur l'afficheur du haut, soit T2, soit T1-T2.</li> <li>■ Un appui long sur la touche °C/°F permet d'afficher la mesure soit en °C soit en °F.</li> </ul>
<p><b>MEM</b> <b>REC</b></p>	<ul style="list-style-type: none"> <li>■ Un appui court sur la touche <b>MEM</b> permet d'enregistrer la mesure et la date.</li> <li>■ Un appui long sur la touche <b>REC</b> permet de démarrer ou d'arrêter une session d'enregistrement.</li> </ul>
	<ul style="list-style-type: none"> <li>■ Un appui court sur la touche  permet d'allumer le rétroéclairage.</li> <li>■ Un appui long sur la touche <b>TYPE</b> permet de sélectionner le type de thermocouple (K, J, T, E, N, R, S) ou de passer de la sonde PT100 à la sonde PT1000.</li> </ul>
<p><b>HOLD</b></p> 	<ul style="list-style-type: none"> <li>■ Un appui court sur la touche <b>HOLD</b> permet de bloquer l'affichage.</li> <li>■ Un appui long sur la touche  permet de démarrer ou d'arrêter la liaison Bluetooth.</li> </ul>
<p><b>MAX</b> <b>MIN</b></p>	<ul style="list-style-type: none"> <li>■ Un appui court sur la touche <b>MAX MIN</b> permet d'entrer dans le mode MAX MIN tout en continuant d'afficher les valeurs courantes.</li> <li>■ Un deuxième appui permet d'afficher la valeur maximale.</li> <li>■ Un troisième appui permet d'afficher la valeur minimale.</li> <li>■ Un quatrième appui permet de revenir au premier appui et d'afficher les valeurs courantes</li> <li>■ Un appui long permet de sortir du mode MAX MIN.</li> </ul>

## 3. CONNEXION À UN PC

### 3.1. OBTENIR LE LOGICIEL DATA LOGGER TRANSFER

Rendez-vous sur notre site Internet pour télécharger la dernière version du logiciel d'application :

[www.chauvin-arnoux.com](http://www.chauvin-arnoux.com)

Allez dans l'onglet **Support**, puis **Télécharger nos logiciels**. Effectuez ensuite une recherche avec le nom de votre appareil.

Téléchargez le logiciel puis installez-le sur votre PC.



Vous devez disposer des droits administrateur sur votre PC pour installer le logiciel Data Logger Transfer.

### 3.2. CONNEXION

L'appareil possède 2 modes de communication :

- Une liaison USB via un cordon USB-micro USB,

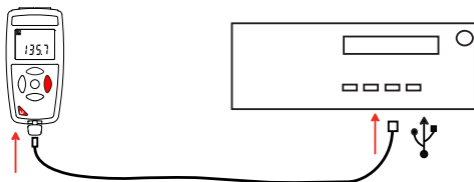

- Une liaison sans fil Bluetooth 4.0 BLE.

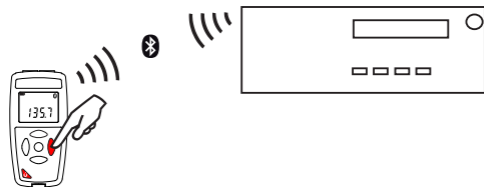

# ENGLISH

Thank you for purchasing this **C.A 1821** or **C.A 1822 thermo-couple thermometer** or **C.A 1823 resistance thermometer**.

For best results from your instrument:

- **read** these operating instructions carefully,
- **comply** with the precautions for use.



WARNING, risk of DANGER! The operator must refer to these instructions whenever this danger symbol appears.



Information or useful tip.



Battery.



Magnet.



The product is declared recyclable following an analysis of the life cycle in accordance with standard ISO 14040.



Chauvin Arnoux has adopted an Eco-Design approach in order to design this appliance. Analysis of the complete lifecycle has enabled us to control and optimize the effects of the product on the environment. In particular this appliance exceeds regulation requirements with respect to recycling and reuse.



The CE marking indicates conformity with European directives, in particular LVD and EMC.



The rubbish bin with a line through it indicates that, in the European Union, the product must undergo selective disposal in compliance with Directive WEEE 2002/96/EC. This equipment must not be treated as household waste.

## USER'S MANUAL

Visit our web site to download the operating instructions for your instrument:

[www.chauvin-arnoux.com](http://www.chauvin-arnoux.com)

Go to the **Products** tab and search on the name of your instrument. When you have found the instrument, go to its page. The user's manual are on the right.

Download it.



# PRECAUTIONS FOR USE

This instrument is compliant with safety standard IEC 61010-2-030, for voltages up to 5V with respect to ground. Failure to observe the safety instructions may result in electric shock, fire, explosion, and destruction of the instrument and of the installations.

- The operator and/or the responsible authority must carefully read and clearly understand the various precautions to be taken in use. Sound knowledge and a keen awareness of electrical hazards are essential when using this instrument.
- Observe the conditions of use, namely the temperature, the relative humidity, the altitude, the degree of pollution, and the place of use.
- Do not use the instrument if it seems to be damaged, incomplete, or poorly close.
- Before each use, check the condition of the insulation on the leads, housing, and accessories. Any item of which the insulation is deteriorated (even partially) must be set aside for repair or scrapping.
- Do not make measurements on bare live conductors. Use a non-contact sensor or a sensor that provides the necessary electrical insulation.
- Always wear personal protective equipment (PPE), in particular insulating gloves, if there is any doubt or it is impossible to measure the voltage levels to which the temperature sensor is connected.
- All troubleshooting and metrological checks must be done by competent, accredited personnel.

## CONTENTS

<b>1. First use.....</b>	<b>10</b>
1.1. Delivery condition .....	10
1.2. Inserting the batteries.....	10
<b>2. Presentation of the instrument .....</b>	<b>11</b>
2.1. C.A 1821 et 1822.....	11
2.2. C.A 1823.....	11
2.3. Keys .....	12
<b>3. Connecting to a PC .....</b>	<b>13</b>
3.1. Get Data Logger Transfer software .....	13
3.2. Connection .....	13

# 1. FIRST USE

## 1.1. DELIVERY CONDITION

C.A 1821 or C.A 1822 thermocouple thermometer or C.A 1823 resistance thermometer.

Supplied in a cardboard box with:

- three AA or LR6 alkaline batteries,
- one USB-micro USB cord,
- one multilingual getting started guide,
- one multilingual safety data sheet,
- one test report,
- one carrying case.

## 1.2. INSERTING THE BATTERIES

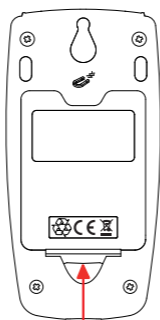

- Press the tab of the battery compartment cover and lift it clear.
- Withdraw the battery compartment cover.
- Insert the new batteries, paying attention to the polarity.
- Close the battery compartment cover; make sure that it is completely and correctly closed.

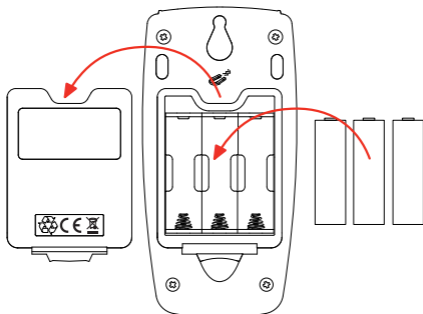

## 2. PRESENTATION OF THE INSTRUMENT



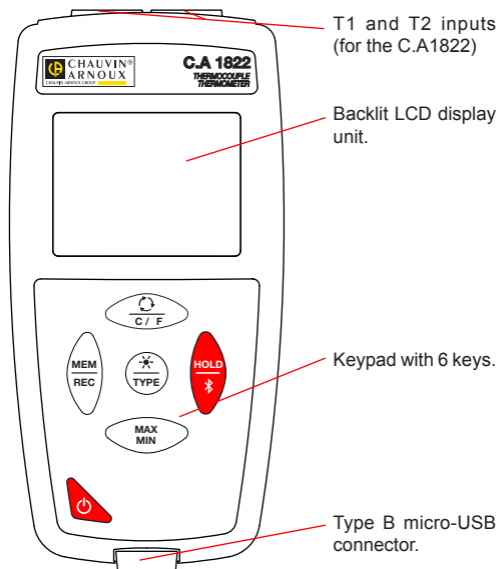



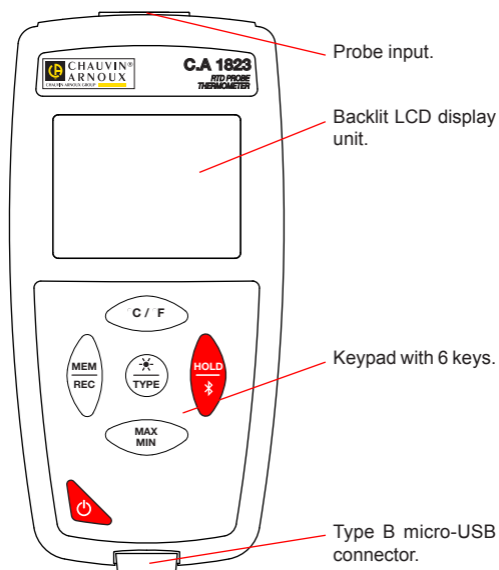

### 2.1. C.A 1821 ET 1822



### 2.2. C.A 1823



## 2.3. KEYS

Key	Function
	<ul style="list-style-type: none"> <li>■ A long press on the  key switches the instrument on.</li> <li>■ When the instrument is on, a long press on the  key switches it off. But it is not possible to switch the instrument off when it is in record mode and is recording.</li> </ul>
	<p>For the C.A1821 and the C.A1823</p> <ul style="list-style-type: none"> <li>■ The °C/°F key toggles the unit in which the temperature is displayed between °C and °F.</li> </ul> <p>For the C.A1822</p> <ul style="list-style-type: none"> <li>■ A short press on the  key toggles the display on the upper display unit between T2 and T1-T2.</li> </ul> <p>A long press on the °C/°F key toggles the unit in which the temperature is displayed between °C and °F.</p>
<p><b>MEM</b> <b>REC</b></p>	<ul style="list-style-type: none"> <li>■ A short press on the <b>MEM</b> key records the measurement and the date.</li> <li>■ A long press on the <b>REC</b> key starts or stops a recording session.</li> </ul>
 <b>TYPE</b>	<ul style="list-style-type: none"> <li>■ A short press on the  key switches on the back-lighting.</li> <li>■ A long press on the <b>TYPE</b> key selects the type of thermocouple (K, J, T, E, N, R, S) or toggles between the PT100 and PT1000 probes.</li> </ul>
<p><b>HOLD</b> </p>	<ul style="list-style-type: none"> <li>■ A short press on the <b>HOLD</b> key freezes the display.</li> <li>■ A long press on the  key activates or deactivates the Bluetooth link.</li> </ul>
<p><b>MAX</b> <b>MIN</b></p>	<ul style="list-style-type: none"> <li>■ A short press on the <b>MAX MIN</b> key opens the MAX MIN mode; the current values continue to be displayed.</li> <li>■ A second press displays the maximum value.</li> <li>■ A third press displays the minimum value.</li> <li>■ A fourth press results in a return to the first-press condition and display of the current values</li> <li>■ A long press is used to exit from the MAX MIN mode.</li> </ul>

## 3. CONNECTING TO A PC

### 3.1. GET DATA LOGGER TRANSFER SOFTWARE

Visit our web site to download the latest version of the application software:

[www.chauvin-arnoux.com](http://www.chauvin-arnoux.com)

Go to the **Support** tab, then **Download our software**. Then search on the name of your instrument.

Download the software, then install it on your PC.



You must have administrator privileges on your PC to install the Data Logger Transfer software.

### 3.2. CONNECTION

The device has 2 communication modes:

- A USB link via a USB-micro USB cord,

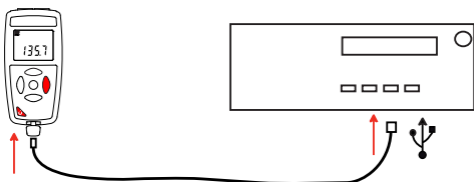

- A Bluetooth 4.0 BLE (Bluetooth Low Energy) wireless link.

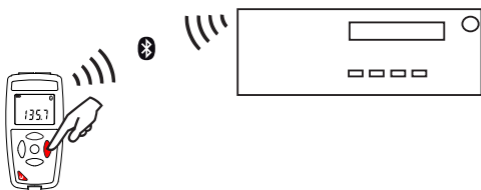

# DEUTSCH

Wir danken Ihnen für das Vertrauen, dass Sie uns mit dem Kauf dieses **Thermometers mit Thermoelement C.A 1821 oder C.A 1822** bzw. eines **Widerstandsthermometers C.A 1823** entgegengebracht haben.

Um die optimale Benutzung Ihres Gerätes zu gewährleisten, bitten wir Sie:

- diese Bedienungsanleitung **sorgfältig zu lesen**,
- die Benutzungshinweise **genau zu beachten**.



**ACHTUNG, GEFAHR!** Sobald dieses Gefahrenzeichen irgendwo erscheint, ist der Benutzer verpflichtet, die Anleitung zu Rate zu ziehen.



Praktischer Hinweis oder guter Tipp.



Batterie



Magnet.



Die Lebenszyklusanalyse des Produkts gemäß ISO14040 hat ergeben, dass das Produkt als recyclingfähig eingestuft wird.



Chauvin Arnoux hat dieses Gerät im Rahmen eines umfassenden Projektes einer umweltgerechten Gestaltung untersucht. Die Lebenszyklusanalyse hat die Kontrolle und Optimierung der Auswirkungen dieses Produkts auf die Umwelt ermöglicht. Genauer gesagt, entspricht dieses Produkt den gesetzten Zielen hinsichtlich Wiederverwertung und Wiederverwendung besser als dies durch die gesetzlichen Bestimmungen festgelegt ist.



Die CE-Kennzeichnung bestätigt die Übereinstimmung mit den europäischen Richtlinien, insbesondere der Niederspannungs-Richtlinie und der EMV-Richtlinie.



Der durchgestrichene Mülleimer bedeutet, dass das Produkt in der europäischen Union gemäß der WEEE-Richtlinie 2002/96/EG einer getrennten Elektroschrott-Verwertung zugeführt werden muss. Das Produkt darf nicht als Haushaltsmüll entsorgt werden.

## BEDIENUNGSANLEITUNG

Rufen Sie unsere Website auf, wo die Bedienungsanleitung Ihres Geräts zum Herunterladen bereitsteht:

Gehen Sie zur Registerkarte **Produkte** und führen Sie mit dem Namen des Geräts als Stichwort eine Suche

durch. Gehen Sie dann zur entsprechenden Seite, die Bedienungsanleitung befindet sich rechter Hand. Nun können Sie sie herunterladen.

## SICHERHEITSHINWEISE

Dieses Gerät erfüllt die Sicherheitsnorm IEC 61010-2-030,1 für 5V-Spannungen gegen Erde. Die Nichtbeachtung der Sicherheitshinweise kann zu Gefahren durch elektrische Schläge, durch Brand oder Explosion, sowie zur Zerstörung des Geräts und der Anlage führen.

- Der Benutzer bzw. die verantwortliche Stelle müssen die verschiedenen Sicherheitshinweise sorgfältig lesen und gründlich verstehen. Die umfassende Kenntnis und das Bewusstsein der elektrischen Gefahren sind bei jeder Benutzung dieses Gerätes unverzichtbar.
- Verwenden Sie das Gerät ausschließlich unter den vorgegebenen Einsatzbedingungen bzgl. Temperatur, Feuchtigkeit, Höhe, Verschmutzungsgrad und Einsatzort.
- Verwenden Sie das Gerät niemals, wenn es beschädigt, unvollständig oder schlecht geschlossen erscheint.
- Vor jedem Gebrauch ist die Unversehrtheit des Gehäuses und Zubehörs zu prüfen. Teile mit auch nur stellenweise beschädigter Isolierung müssen für eine Reparatur oder für die Entsorgung ausgesondert werden.
- An spannungsführenden blanken Leitungen dürfen keine Messungen vorgenommen werden. In einem solchen Fall ist ein berührungsloser Sensor oder ein Sensor, der die notwendige elektrische Isolierung gewährleistet, zu verwenden.
- Im Zweifelsfall, oder wenn die Spannungswerte, denen der Temperaturmessfühler ausgesetzt ist, nicht ermittelt werden können, muss eine geeignete Schutzausrüstung und insbesondere Isolierhandschuhe verwendet werden!
- Reparatur und messtechnische Überprüfung darf nur durch zugelassenes Fachpersonal erfolgen.

## INHALTSVERZEICHNIS

<b>1. Erste Inbetriebnahme</b> .....	<b>16</b>
1.1. Lieferumfang .....	16
1.2. Batterien einlegen .....	16
<b>2. Gerätevorstellung</b> .....	<b>17</b>
2.1. C.A 1821 und 1822.....	17
2.2. C.A 1823.....	17
2.3. Tasten.....	18
<b>3. Verbindung mit einem PC</b> .....	<b>19</b>
3.1. Data Logger Transfer Software installieren....	19
3.2. Anschluss .....	19

# 1. ERSTE INBETRIEBNAHME

## 1.1. LIEFERUMFANG

Thermometer mit Thermoelement C.A 1821 oder C.A 1822  
bzw. Widerstandsthermometer C.A 1823

Lieferung in Karton mit:

- 3 Alkalibatterien AA bzw. LR6
- 1 USB/Micro-USB-Kabel
- 1 mehrsprachige Schnellstart-Anleitung
- 1 mehrsprachiges Sicherheitsdatenblatt
- 1 Prüfbericht
- 1 Tasche

## 1.2. BATTERIEN EINLEGEN

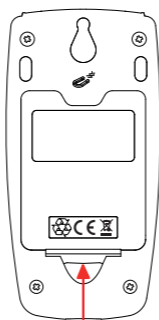

- Auf den Clip am Batteriefach drücken und anheben.
- Batteriefach entfernen.
- Neue Batterien einlegen, dabei die Polarität berücksichtigen.
- Batteriefach ordentlich ganz schließen.

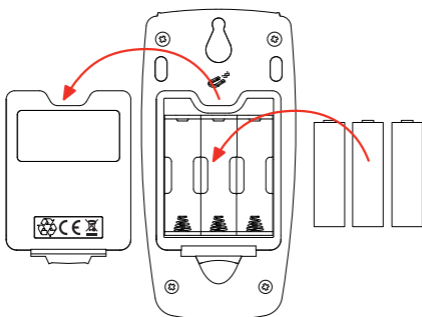



## 2. GERÄTEVORSTELLUNG



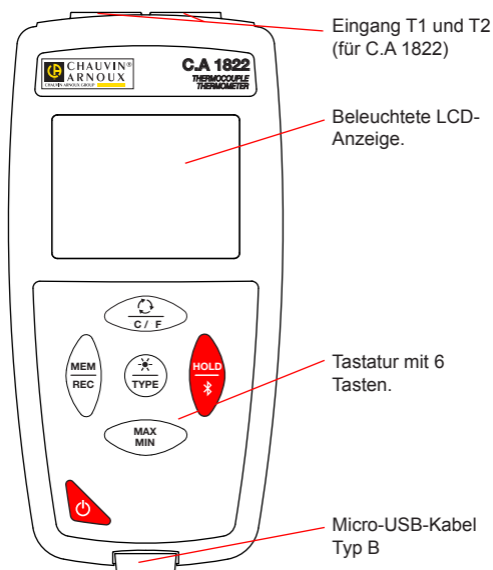



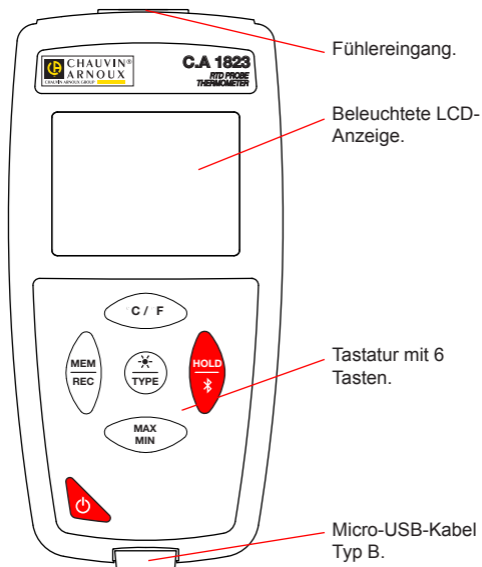

### 2.1. C.A 1821 UND 1822



### 2.2. C.A 1823



## 2.3. TASTEN

Taste	Funktion
	<ul style="list-style-type: none"> <li>■ Drückt man lang auf die Taste , wird das Gerät ein-</li> <li>■ und ebenso auch wieder ausgeschaltet. Allerdings lässt sich das Gerät nicht ausschalten, wenn es Speichermodus ist und gerade aufzeichnet.</li> </ul>
	<p>Für C.A 1821 und C.A 1823</p> <ul style="list-style-type: none"> <li>■ Mit der Taste °C/°F zeigt das Gerät die Messdaten entweder in °C oder in °F an.</li> </ul> <p>Für C.A 1822</p> <ul style="list-style-type: none"> <li>■ Mit der Taste  wird am oberen Display zwischen T2 und T1-T2 umgeschaltet.</li> <li>■ Drückt man lang auf die Taste °C/°F zeigt das Gerät die Messdaten entweder in °C oder in °F an.</li> </ul>
<p><b>MEM</b> <b>REC</b></p>	<ul style="list-style-type: none"> <li>■ Mit der Taste <b>MEM</b> (kurz drücken) werden Messdaten und Datum gespeichert.</li> <li>■ Drückt man lang auf die Taste <b>REC</b> wird ein Speichervorgang ein- bzw. ausgeschaltet.</li> </ul>
 <p><b>TYPE</b></p>	<ul style="list-style-type: none"> <li>■ Drückt man lang auf die Taste , wird die Hintergrundbeleuchtung eingeschaltet.</li> <li>■ Drückt man lang auf die Taste <b>TYPE</b>, kann das Thermoelement eingestellt (K, J, T, E, N, R, S) bzw. von Temperaturfühler PT100 auf Fühler PT1000 gewechselt werden.</li> </ul>
<p><b>HOLD</b></p> 	<ul style="list-style-type: none"> <li>■ Mit der Taste <b>HOLD</b> wird das Display „eingefroren“.</li> <li>■ Drückt man lang auf die Taste  wird eine Bluetooth-Verbindung aufgebaut bzw. getrennt.</li> </ul>
<p><b>MAX</b> <b>MIN</b></p>	<ul style="list-style-type: none"> <li>■ Mit der Taste <b>MAX MIN</b> (kurz drücken) wird der MAX MIN-Modus eingestellt, wobei jedoch die aktuellen Messwerte weiter auf dem Display erscheinen.</li> <li>■ Beim zweiten Tastendruck wird der Höchstwert angezeigt.</li> <li>■ Beim dritten Tastendruck wird der Mindestwert angezeigt.</li> <li>■ Beim vierten Tastendruck gelangt man wieder in die Ausgangsposition mit den aktuellen Messwerten zurück.</li> <li>■ Drückt man lang auf die Taste, wird der MAX MIN-Modus wieder beendet.</li> </ul>

## 3. VERBINDUNG MIT EINEM PC

### 3.1. DATA LOGGER TRANSFER SOFTWARE INSTALLIEREN

Rufen Sie unsere Website auf, wo die neueste Version der Anwendungssoftware zum Herunterladen bereitsteht:

[www.chauvin-arnoux.com](http://www.chauvin-arnoux.com)

Gehen Sie zur Registerkarte **Support**, und dort unter **Softwares herunterladen**. Führen Sie mit dem Namen des Geräts als Stichwort eine Suche durch.

Laden Sie die Software dann herunter und installieren Sie sie auf Ihrem PC.



Für die Installation des Data Logger Transfer auf Ihrem PC brauchen Sie Systemverwalter-Zugriffsrechte.

### 3.2. ANSCHLUSS

Das Gerät bietet dem Nutzer 2 Kommunikationsarten:

- Einen USB-Anschluss über USB-Micro-USB-Kabel

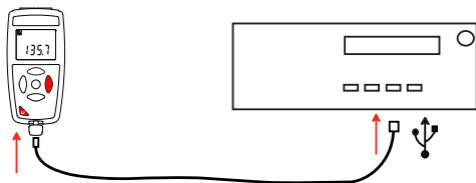

- und eine drahtlose Bluetooth-Übertragung 4.0 BLE (Bluetooth Low Energy).

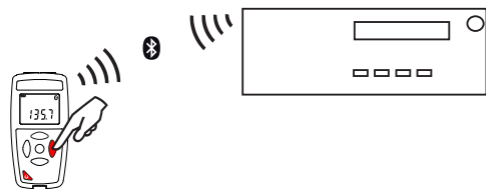

# ITALIANO

Avete appena acquistato un **termometro a termocoppia C.A 1821** o **C.A 1822**, oppure un **termometro a sonda resistiva C.A 1823** e vi ringraziamo della vostra fiducia.

Per ottenere le migliori prestazioni dal vostro strumento:

- **Leggete** attentamente il manuale d'uso.
- **Rispettate** le precauzioni d'uso.



**ATTENZIONE**, rischio di **PERICOLO!** L'operatore deve consultare il presente manuale d'uso ogni volta che vedrà questo simbolo di pericolo.



Informazione o astuzia utile.



Pila.



Magnete.



Il prodotto è dichiarato riciclabile in seguito all'analisi del ciclo di vita conformemente alla norma ISO 14040.



Chauvin Arnoux ha ideato questo strumento nell'ambito di un processo globale di Ecodesign. L'analisi del ciclo di vita ha permesso di controllare e di ottimizzare gli effetti di questo prodotto sull'ambiente. Il prodotto risponde più specificamente a obiettivi di riciclaggio e di recupero superiori a quelli della normativa.



La marcatura CE indica la conformità alle direttive europee, relativamente alla DBT e CEM.



La pattumiera sbarrata significa che nell'Unione Europea, il prodotto è oggetto di smaltimento differenziato conformemente alla direttiva DEEE 2002/96/CE (concernente gli strumenti elettrici ed elettronici). Questo materiale non va trattato come rifiuto domestico.

## MANUALE D'USO

Visitate il nostro sito Internet per scaricare il manuale d'uso del vostro strumento:

[www.chauvin-arnoux.com](http://www.chauvin-arnoux.com)

Aprire il tab **Prodotti** per effettuare una ricerca con il nome del vostro strumento. Una volta trovato lo strumento andate sulla pagina corrispondente. Il manuale d'uso si trova sulla destra: scaricatelo.

# PRECAUZIONI D'USO

Questo strumento è conforme alla norma di sicurezza IEC 61010-2-030, per tensioni fino a 5 V rispetto alla terra. Il mancato rispetto delle indicazioni di sicurezza può causare un rischio di shock elettrico, incendio, esplosione, distruzione dello strumento e degli impianti.

- L'operatore (e/o l'autorità responsabile) deve leggere attentamente e assimilare le varie precauzioni d'uso. La buona conoscenza e la perfetta coscienza dei rischi correlati all'elettricità sono indispensabili per ogni utilizzo di questo strumento.
- Rispettare le condizioni d'utilizzo, ossia la temperatura, l'umidità, l'altitudine, il grado d'inquinamento e il luogo d'utilizzo.
- Non utilizzate lo strumento se sembra danneggiato, incompleto o chiuso male.
- Prima di ogni utilizzo verificate che gli isolanti dei cavi, le scatole e gli accessori siano in buone condizioni. Qualsiasi elemento il cui isolante è deteriorato (seppure parzialmente) va isolato per riparazione o portato in discarica.
- Non effettuate misure su conduttori nudi sotto tensione. Utilizzate un sensore senza contatto o un sensore che fornisce il necessario isolamento elettrico.
- Utilizzate sistematicamente un dispositivo di protezione individuale (DPI), per esempio, i guanti isolanti. In caso di dubbio o d'incapacità a misurare il livello delle tensioni cui il sensore di temperatura è collegato.
- Qualsiasi operazione d'intervento o di verifica metrologica va effettuata da personale competente e autorizzato.

## SOMMARIO

<b>1. Prima messa in servizio.....</b>	<b>22</b>
1.1. Caratteristiche della consegna .....	22
1.2. Inserimento delle pile .....	22
<b>2. Presentazione delle strumenti.....</b>	<b>23</b>
2.1. C.A 1821 e 1822.....	23
2.2. C.A 1823.....	23
2.3. Tasti .....	24
<b>3. Connessione a un PC.....</b>	<b>25</b>
3.1. Ottenere il software Data Logger Transfer .....	25
3.2. Connessione .....	25

# 1. PRIMA MESSA IN SERVIZIO

## 1.1. CARATTERISTICHE DELLA CONSEGNA

Termometro a termocoppia C.A 1821 o C.A 1822, oppure un termometro a sonda resistiva C.A 1823

Fornita in scatola di cartone con:

- Tre pile alcaline AA o LR6,
- un cavo USB-micro USB,
- una guida di avvio rapido multilingue,
- una scheda di sicurezza multilingue,
- un report di test,
- una borsa.

## 1.2. INSERIMENTO DELLE PILE

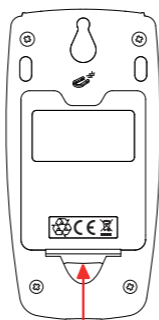

- Premete la linguetta dello sportello delle pile e solleva telo.
- Rimuovete lo sportello delle pile.
- Inserite le nuove pile rispettando la polarità.
- Richiudete lo sportello delle pile accertandovi che sia completamente e correttamente chiuso.

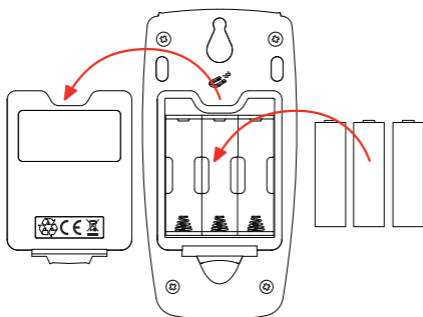

## 2. PRESENTAZIONE DELLE STRUMENTI



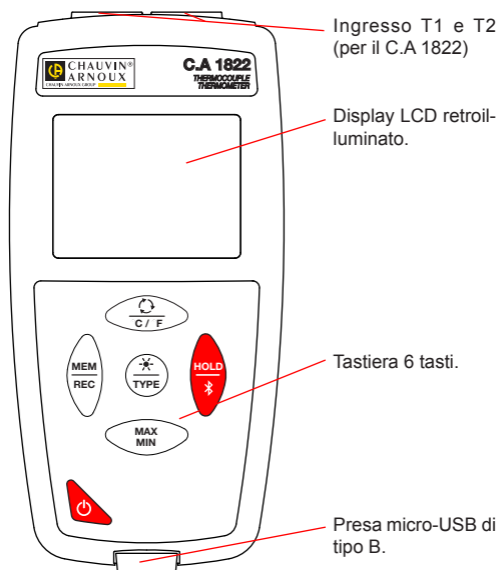



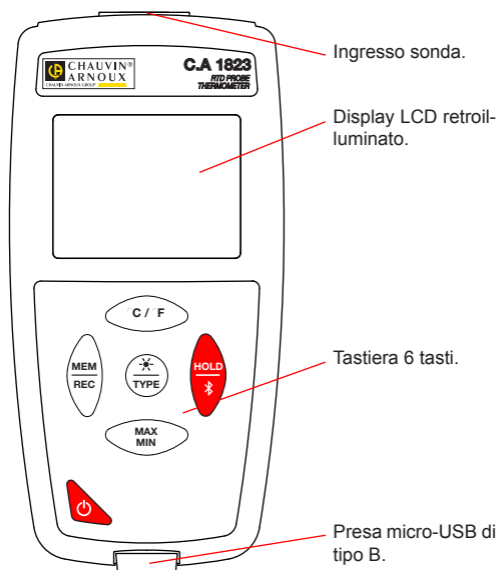



### 2.1. C.A 1821 E 1822



### 2.2. C.A 1823



## 2.3. TASTI

Tasto	Funzione
	<ul style="list-style-type: none"> <li>■ Una pressione lunga sul tasto  permette di accendere lo strumento.</li> <li>■ In maniera identica una pressione lunga sul tasto  permette di spegnere lo strumento. Ma non è possibile spegnere lo strumento quando è in modo registratore e in corso di registrazione.</li> </ul>
	<p>Per il C.A 1821 e il C.A 1823</p> <ul style="list-style-type: none"> <li>■ Il tasto <b>C°/°F</b> permette di visualizzare la misura in °C oppure in °F.</li> </ul> <p>Per il C.A 1822</p> <ul style="list-style-type: none"> <li>■ Una pressione breve sul tasto  permette di visualizzare sul display superiore, T2 oppure T1-T2.</li> <li>■ Una pressione lunga sul tasto <b>C°/F°</b> permette di visualizzare la misura in °C oppure in °F.</li> </ul>
	<ul style="list-style-type: none"> <li>■ Una pressione breve sul tasto <b>MEM</b> permette di registrare la misura e la data.</li> <li>■ Una pressione lunga sul tasto <b>REC</b> permette di avviare o fermare una sessione di registrazione.</li> </ul>
	<ul style="list-style-type: none"> <li>■ Un appui court sur la touche  permet d'allumer le rétroéclairage.</li> <li>■ Un appui long sur la touche <b>TYPE</b> permet de sélectionner le type de thermocouple (K, J, T, E, N, R, S) ou de passer de la sonde PT100 à la sonde PT1000.</li> </ul>
	<ul style="list-style-type: none"> <li>■ Una pressione breve sul tasto <b>HOLD</b> permette di bloccare la visualizzazione.</li> <li>■ Una pressione lunga sul tasto  permette di avviare o fermare il collegamento Bluetooth.</li> </ul>
	<ul style="list-style-type: none"> <li>■ Una pressione breve sul tasto <b>MAX MIN</b> permette di entrare nel modo MAX MIN pur continuando a visualizzare i valori correnti.</li> <li>■ Una seconda pressione permette di visualizzare il valore massimo.</li> <li>■ Una terza pressione permette di visualizzare il valore minimo.</li> <li>■ Una quarta pressione permette di ritornare alla prima pressione e visualizzare i valori correnti.</li> <li>■ Una pressione lunga permette di uscire dal modo MAX MIN.</li> </ul>



## 3. CONNESSIONE A UN PC

### 3.1. OTTENERE IL SOFTWARE DATA LOGGER TRANSFER

Visitate il nostro sito Internet per scaricare l'ultima versione del software applicativo:

[www.chauvin-arnoux.com](http://www.chauvin-arnoux.com)

Aprire il tab **Supporto**, poi **Download dei nostri software**. Effettuate in seguito una ricerca con il nome del vostro strumento.

Scaricate il software e poi installatelo sul vostro PC



Dovete possedere i diritti amministrativi sul vostro PC per installare il software Data Logger Transfer

### 3.2. CONNESSIONE

Il dispositivo possiede 2 modalità di comunicazione:

- Un collegamento USB mediante un cavo USB-micro USB,

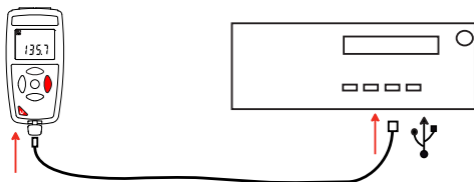

- Un collegamento senza fili Bluetooth 4.0 BLE (Bluetooth Low Energy)

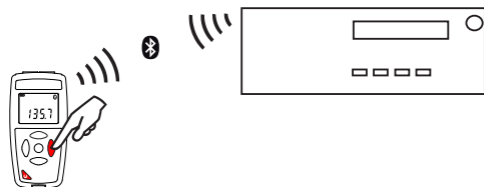

# ESPAÑOL

Usted acaba de adquirir un **termómetro con termopar C.A 1821** o **C.A 1822**, o un **termómetro con sonda resistiva C.A 1823** y le agradecemos la confianza que ha depositado en nosotros.

Para conseguir las mejores prestaciones de su instrumento:

- **lea** atentamente el manual de instrucciones,
- **respete** las precauciones de uso.



¡ATENCIÓN, riesgo de PELIGRO! El operador debe consultar el presente manual de instrucciones cada vez que aparece este símbolo de peligro.



Información o truco útil.



Pila.



Imán.



El producto se ha declarado reciclable tras un análisis del ciclo de vida de acuerdo con la norma ISO14040.



Chauvin Arnoux ha estudiado este aparato en el marco de una iniciativa global de ecodiseño. El análisis del ciclo de vida ha permitido controlar y optimizar los efectos de este producto en el medio ambiente. El producto satisface con mayor precisión a objetivos de reciclaje y aprovechamiento superiores a los estipulados por la reglamentación.



La marca CE indica la conformidad con las directivas europeas, especialmente DBT y CEM.



El contenedor de basura tachado significa que, en la Unión Europea, el producto deberá ser objeto de una recogida selectiva de conformidad con la directiva RAEE 2002/96/CE: este material no se debe tratar como un residuo doméstico.

## MANUAL DE INSTRUCCIONES

Visite nuestro sitio web para descargar el manual de instrucciones de su instrumento:

En la sección **Productos**, realice una búsqueda con el nombre de su instrumento. Una vez encontrado el instrumento, vaya a su página. El manual de instrucciones se encuentra a la derecha.

Descárguelo.

# PRECAUCIONES DE USO

Este instrumento cumple con la norma de seguridad IEC 61010-2-030, para tensiones de 5 V con respecto a la tierra. El incumplimiento de las instrucciones de seguridad puede ocasionar un riesgo de descarga eléctrica, fuego, explosión, destrucción del instrumento e instalaciones.

- El operador y/o la autoridad responsable deben leer detenidamente y entender correctamente las distintas precauciones de uso. El pleno conocimiento de los riesgos eléctricos es imprescindible para cualquier uso de este instrumento.
- Respete las condiciones de uso, es decir la temperatura, la humedad, la altitud, el grado de contaminación y el lugar de uso.
- No utilice el instrumento si parece estar dañado, incompleto o mal cerrado.
- Antes de cada uso, compruebe el buen estado de la carcasa y de los accesorios. Todo elemento que presente desperfectos en el aislamiento (aunque sean menores) debe enviarse a reparar o desecharse.
- No realice una medida en conductores desnudos conectados. Utilice un sensor sin contacto o un sensor con un aislamiento eléctrico necesario.
- En caso de duda o de incapacidad para medir el nivel de tensión sobre el cual el sensor de temperatura está conectado, utilice sistemáticamente un equipo de protección individual (EPI), especialmente guantes aislantes.
- Toda operación de reparación de avería o verificación metrológica debe efectuarse por una persona competente y autorizada.

## ÍNDICE

<b>1. Primera puesta en marcha.....</b>	<b>28</b>
1.1. Estado de suministro.....	28
1.2. Colocación de las pilas.....	28
<b>2. Presentación de los instrumentos.....</b>	<b>29</b>
2.1. C.A 1821 y 1822.....	29
2.2. C.A 1823.....	29
2.3. Teclas .....	30
<b>3. Conexión a un PC.....</b>	<b>31</b>
3.1. Obtener el software Data Logger Transfer.....	31
3.2. Conexión .....	31

# 1. PRIMERA PUESTA EN MARCHA

## 1.1. ESTADO DE SUMINISTRO

Termómetro con termopar C.A 1821 o C.A 1822, o termómetro con sonda resistiva C.A 1823

Entregado en una caja de cartón con:

- tres pilas alcalinas AA o LR6,
- un cable USB-micro USB,
- una guía de inicio rápido en varios idiomas,
- una ficha de seguridad en varios idiomas,
- un informe de prueba,
- una bolsa.

## 1.2. COLOCACIÓN DE LAS PILAS

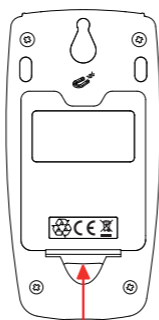

- Presione la lengüeta de la tapa de las pilas y levántela.
- Quite la tapa de las pilas.
- Coloque las nuevas pilas según la polaridad.
- Cierre la tapa de las pilas y asegúrese de su completo y correcto cierre.

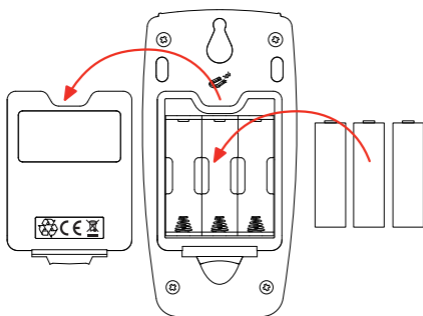

## 2. PRESENTACIÓN DE LOS INSTRUMENTOS



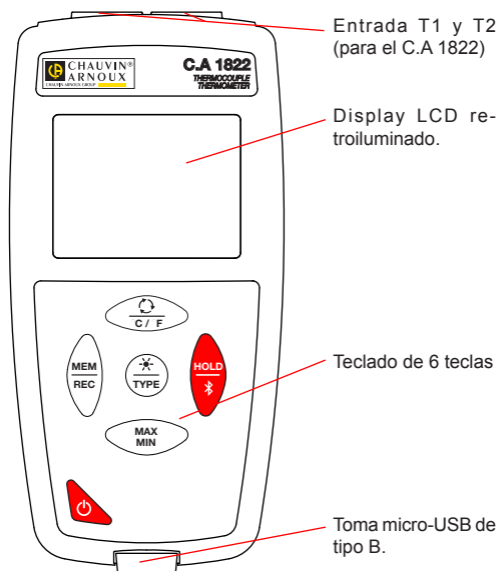



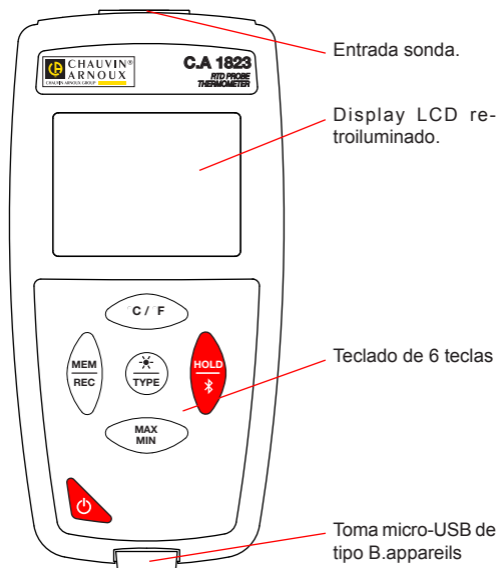

### 2.1. C.A 1821 Y 1822



### 2.2. C.A 1823



## 2.3. TECLAS

Tecla	Función
	<ul style="list-style-type: none"> <li>■ Mantener pulsada la tecla  permite encender el instrumento.</li> <li>■ Asimismo, mantener pulsada la tecla  permite apagar el instrumento. Pero no se puede apagar el instrumento cuando está en modo registrador y está registrando.</li> </ul>
	<p>Para el C.A 1821 y el C.A 1823</p> <ul style="list-style-type: none"> <li>■ La tecla °C/°F permite visualizar la medida o bien en °C o bien en °F.</li> </ul> <p>Para el C.A 1822</p> <ul style="list-style-type: none"> <li>■ Pulsar brevemente la tecla  permite visualizar en el display de arriba o bien T2, o bien T1-T2.</li> <li>■ Mantener pulsada la tecla °C/°F permite visualizar la medida o bien en °C o bien en °F.</li> </ul>
<p><b>MEM</b> <b>REC</b></p>	<ul style="list-style-type: none"> <li>■ Pulsar brevemente la tecla <b>MEM</b> permite guardar la medida y la fecha.</li> <li>■ Mantener pulsada la tecla <b>REC</b> permite iniciar o detener una sesión de registro.</li> </ul>
 <p><b>TYPE</b></p>	<ul style="list-style-type: none"> <li>■ Pulsar brevemente la tecla  permite encender la retroiluminación.</li> <li>■ Mantener pulsada la tecla <b>TYPE</b> permite seleccionar el tipo de termopar (K, J, T, E, N, R, S) o pasar de la sonda PT100 a la sonda PT1000.</li> </ul>
<p><b>HOLD</b></p> 	<ul style="list-style-type: none"> <li>■ Pulsar brevemente la tecla <b>HOLD</b> permite congelar la visualización.</li> <li>■ Mantener pulsada la tecla  permite iniciar o detener la conexión Bluetooth.</li> </ul>
<p><b>MAX</b> <b>MIN</b></p>	<ul style="list-style-type: none"> <li>■ Pulsar brevemente la tecla <b>MAX MIN</b> permite entrar en el modo MAX MIN mientras se sigue visualizando los valores corrientes.</li> <li>■ Pulsar por segunda vez permite visualizar el valor máximo.</li> <li>■ Pulsar por tercera vez permite visualizar el valor mínimo.</li> <li>■ Pulsar por cuarta vez permite volver a la primera pulsación y visualizar los valores corrientes.</li> <li>■ Al mantenerla pulsada, se sale del modo MAX MIN.</li> </ul>

## 3. CONEXIÓN A UN PC

### 3.1. OBTENER EL SOFTWARE DATA LOGGER TRANSFER

Visite nuestro sitio web para descargar la última versión del software de aplicación:

[www.chauvin-arnoux.com](http://www.chauvin-arnoux.com)

Entre en la sección **Soporte**, y a continuación en **Descargar nuestros software**. A continuación, realice una búsqueda con el nombre de su instrumento.

Descargue el software y luego instálelo en su PC.



Debe disponer de los derechos de administrador en su PC para instalar el software Data Logger Transfer.

### 3.2. CONEXIÓN

El instrumento consta de 2 modos de comunicación:

- Una conexión con cable USB-micro USB,

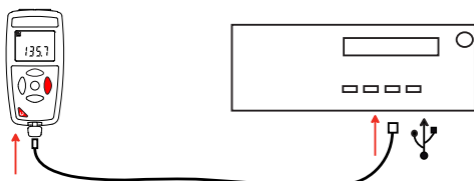

- Una conexión inalámbrica Bluetooth 4.0 BLE (Bluetooth Low Energy).

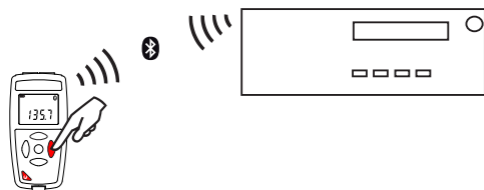



ICS Schneider Messtechnik GmbH  
Briesestraße 59  
D-16562 Hohen Neuendorf / OT Bergfelde

Tel.: 03303 / 50 40 66  
Fax: 03303 / 50 40 68

[info@ics-schneider.de](mailto:info@ics-schneider.de)  
[www.ics-schneider.de](http://www.ics-schneider.de)