



SIEMENS

SITRANS L

Radar level transmitters
SITRANS LR250 with PROFIBUS
PA



Compact Operating Instructions

<u>Introduction</u>	1
<u>Safety information</u>	2
<u>Description</u>	3
<u>Installing/mounting</u>	4
<u>Connecting</u>	5
<u>Commissioning</u>	6
<u>Remote operation</u>	7
<u>Service and maintenance</u>	8
<u>Technical data</u>	9
<u>Product documentation and support</u>	A

Legal information

Warning notice system

This manual contains notices you have to observe in order to ensure your personal safety, as well as to prevent damage to property. The notices referring to your personal safety are highlighted in the manual by a safety alert symbol, notices referring only to property damage have no safety alert symbol. These notices shown below are graded according to the degree of danger.

 DANGER
indicates that death or severe personal injury will result if proper precautions are not taken.
 WARNING
indicates that death or severe personal injury may result if proper precautions are not taken.
 CAUTION
indicates that minor personal injury can result if proper precautions are not taken.
NOTICE
indicates that property damage can result if proper precautions are not taken.

If more than one degree of danger is present, the warning notice representing the highest degree of danger will be used. A notice warning of injury to persons with a safety alert symbol may also include a warning relating to property damage.

Qualified Personnel

The product/system described in this documentation may be operated only by **personnel qualified** for the specific task in accordance with the relevant documentation, in particular its warning notices and safety instructions. Qualified personnel are those who, based on their training and experience, are capable of identifying risks and avoiding potential hazards when working with these products/systems.

Proper use of Siemens products

Note the following:

 WARNING
Siemens products may only be used for the applications described in the catalog and in the relevant technical documentation. If products and components from other manufacturers are used, these must be recommended or approved by Siemens. Proper transport, storage, installation, assembly, commissioning, operation and maintenance are required to ensure that the products operate safely and without any problems. The permissible ambient conditions must be complied with. The information in the relevant documentation must be observed.

Trademarks

All names identified by ® are registered trademarks of Siemens AG. The remaining trademarks in this publication may be trademarks whose use by third parties for their own purposes could violate the rights of the owner.

Disclaimer of Liability

We have reviewed the contents of this publication to ensure consistency with the hardware and software described. Since variance cannot be precluded entirely, we cannot guarantee full consistency. However, the information in this publication is reviewed regularly and any necessary corrections are included in subsequent editions.

Table of contents

1	Introduction.....	5
1.1	LR250 PA manual usage.....	5
1.2	Technical publications	5
1.3	Purpose of this documentation	5
1.4	Industrial use note.....	5
1.5	Checking the consignment	6
1.6	Security information.....	6
1.7	Transportation and storage.....	7
1.8	Notes on warranty	7
2	Safety information	9
2.1	Preconditions for safe use	9
2.1.1	Safety marking symbols.....	9
2.1.2	Laws and directives.....	9
2.1.3	FCC Conformity	10
2.1.4	Industry Canada conformity.....	10
2.1.5	Industry Canada conformity note	11
2.1.6	Conformity with European directives.....	11
2.1.7	Radio Equipment Directive (RED) 2014/53/EU	12
2.1.8	CE Electromagnetic Compatibility (EMC) Conformity	12
2.2	Improper device modifications	13
2.3	Requirements for special applications.....	13
2.4	Use in hazardous areas.....	13
3	Description	15
3.1	SITRANS LR250 overview	15
4	Installing/mounting.....	17
4.1	Basic safety information.....	17
4.1.1	Unsuitable cables, cable glands and/or plugs	18
4.1.2	Pressure applications	18
4.1.2.1	Pressure Equipment Directive, PED, 14/68/EU.....	19
4.2	Installation location requirements.....	19
4.3	Proper mounting.....	20
4.3.1	Mounting location	20
4.3.2	Nozzle design.....	21
4.3.3	Nozzle location	22
4.4	Installation instructions	24
4.4.1	Threaded versions.....	25

4.4.2	Flanged versions	25
4.4.3	Hygienic versions	27
4.5	Disassembly.....	28
5	Connecting.....	29
5.1	Basic safety information	29
5.2	Connecting SITRANS LR250.....	30
5.3	Wiring setups for hazardous area installations	32
5.3.1	Intrinsically safe wiring.....	33
5.3.2	Non-sparking wiring.....	34
5.4	Instructions specific to hazardous area installations	34
5.4.1	(Reference European ATEX Directive 2014/34/EU)	34
6	Commissioning.....	37
6.1	Basic safety information	37
6.2	Programming SITRANS LR250	37
6.2.1	The LCD display.....	37
6.2.2	Device status icons	39
6.2.3	Handheld programmer (Part No. 7ML1930-1BK)	39
6.2.4	Programming via the handheld programmer	41
6.2.5	Quick Start Wizard via the handheld programmer	45
7	Remote operation	49
7.1	SITRANS Communications: PROFIBUS PA	49
8	Service and maintenance.....	51
8.1	Basic safety information	51
8.2	Cleaning.....	51
8.3	Maintenance and repair work.....	52
8.3.1	Unit repair and excluded liability	53
8.3.2	Part replacement.....	53
8.4	Disposal.....	54
8.5	Return procedure	54
8.5.1	Return procedure	54
9	Technical data.....	55
9.1	Power	56
A	Product documentation and support.....	57
A.1	Product documentation.....	57
A.2	Technical support.....	58
	Index.....	59

Introduction

1.1 LR250 PA manual usage

Note

This manual applies to the SITRANS LR250 (PROFIBUS PA) only.

1.2 Technical publications

Follow these operating instructions for quick, trouble-free installation, and maximum accuracy and reliability of your device.

We always welcome suggestions and comments about manual content, design, and accessibility. Please direct your comments to:

Technical publications (<mailto:techpubs.smpi@siemens.com>)

1.3 Purpose of this documentation

These instructions are a brief summary of important features, functions and safety information, and contain all information required for safe use of the device. Read the instructions carefully prior to installation and commissioning. In order to use the device correctly, first review its principle of operation.

The instructions are aimed at persons who install and commission the device.

To realize optimum performance from the device, read the complete operating instructions.

Complete operating instructions can be downloaded from our web site:

Product page (<http://www.siemens.com/LR250>)

The printed manual is available from your local Siemens representative.

1.4 Industrial use note

NOTICE
Use in a domestic environment
This Class B Group 1 equipment is intended for use in industrial areas.
In a domestic environment this device may cause radio interference.

1.5 Checking the consignment

1. Check the packaging and the delivered items for visible damages.
2. Report any claims for damages immediately to the shipping company.
3. Retain damaged parts for clarification.
4. Check the scope of delivery by comparing your order to the shipping documents for correctness and completeness.

 WARNING
Using a damaged or incomplete device Risk of explosion in hazardous areas. <ul style="list-style-type: none">• Do not use damaged or incomplete devices.

1.6 Security information

Siemens provides products and solutions with industrial security functions that support the secure operation of plants, systems, machines, and networks.

In order to protect plants, systems, machines and networks against cyber threats, it is necessary to implement – and continuously maintain – a holistic, state-of-the-art industrial security concept. Siemens' products and solutions only form one element of such a concept.

Customer is responsible to prevent unauthorized access to its plants, systems, machines and networks. Systems, machines and components should only be connected to the enterprise network or the internet if and to the extent necessary and with appropriate security measures (e.g. use of firewalls and network segmentation) in place.

Additionally, Siemens' guidance on appropriate security measures should be taken into account. You can find more information about industrial security by visiting:
<http://www.siemens.com/industrialsecurity>.

Siemens' products and solutions undergo continuous development to make them more secure. Siemens strongly recommends to apply product updates as soon as available and to always use the latest product versions. Use of product versions that are no longer supported, and failure to apply latest updates may increase customer's exposure to cyber threats.

To stay informed about product updates, subscribe to the Siemens Industrial Security RSS Feed under
<http://www.siemens.com/industrialsecurity>.

1.7 Transportation and storage

To guarantee sufficient protection during transport and storage, observe the following:

- Keep the original packaging for subsequent transportation.
- Devices/replacement parts should be returned in their original packaging.
- If the original packaging is no longer available, ensure that all shipments are properly packaged to provide sufficient protection during transport. Siemens cannot assume liability for any costs associated with transportation damages.

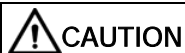

Insufficient protection during storage

The packaging only provides limited protection against moisture and infiltration.

- Provide additional packaging as necessary.

1.8 Notes on warranty

The contents of this manual shall not become part of or modify any prior or existing agreement, commitment or legal relationship. The sales contract contains all obligations on the part of Siemens as well as the complete and solely applicable warranty conditions. Any statements regarding device versions described in the manual do not create new warranties or modify the existing warranty.

The content reflects the technical status at the time of publishing. Siemens reserves the right to make technical changes in the course of further development.



Safety information

2.1 Preconditions for safe use

This device left the factory in good working condition. In order to maintain this status and to ensure safe operation of the device, observe these instructions and all the specifications relevant to safety.

Observe the information and symbols on the device. Do not remove any information or symbols from the device. Always keep the information and symbols in a completely legible state.

2.1.1 Safety marking symbols

In manual	On product	Description
	 (Label on product: yellow back- ground.)	WARNING: refer to accompanying documents (manual) for details.

2.1.2 Laws and directives

Observe the test certification, provisions and laws applicable in your country during connection, assembly and operation.

2.1.3 FCC Conformity

US Installations only: Federal Communications Commission (FCC) rules

Note

- This device has been tested and found to comply with the limits Class B digital device part 15 of the FCC Rules. These limits are designed to provide reasonable protection against harmful interference when the equipment is operated in a commercial environment.
 - This device has also been tested and found to comply with the limits §15.256, Subpart C- Intentional radiators, pursuant to Part 15 of the FCC Rules. These limits are designed to provide reasonable protection against harmful interference when the equipment is operated in a commercial environment.
 - This device generates, uses, and can radiate radio frequency energy and, if not installed and used in accordance with the instruction manual, may cause harmful interference to radio communications, in which case the user will be required to correct the interference at his/her own expense.
 - This device is certified to measure levels in fixed or mobile enclosed tanks made from metal, concrete or materials with similar RF attenuating properties.
 - Devices equipped with the aluminum horn or the 3 inch or 4 inch stainless horn antennas may be used to measure levels in open air environments or outside enclosed tanks, subject to the following conditions:
 - Devices shall be installed and maintained to ensure a vertically downward orientation of the transmit antenna's main beam.
 - Devices shall be installed only at fixed locations. Devices shall not operate while being moved or while inside a moving container.
 - Hand-held applications and residential use are prohibited.
-

2.1.4 Industry Canada conformity

Canada Installations only: Industry Canada (IC) rules

NOTICE
Use on a "no-interference, no-protection" basis
The installation of the LPR/TLPR device shall be done by trained installers, in strict compliance with the manufacturer's instructions.
<ul style="list-style-type: none">• The use of this device is on a "no-interference, no-protection" basis. That is, the user shall accept operations of high-powered radar in the same frequency band which may interfere with or damage this device. However, devices found to interfere with primary licensing operations will be required to be removed at the user's expense.

2.1.5 Industry Canada conformity note

Note

- This device has been tested and found to comply with the limits RS- 211 - Level Probing Radar Equipment. These limits are designed to provide reasonable protection against harmful interference when the equipment is operated in a commercial environment.
- This device is certified to measure levels in fixed or mobile enclosed tanks made from metal, concrete or materials with similar RF attenuating properties.
- Devices equipped with the aluminum horn or the 3 inch or 4 inch stainless horn antennas may be used to measure levels in open air environments or outside enclosed tanks, subject to the following conditions:
 - Devices shall be installed and maintained to ensure a vertically downward orientation of the transmit antenna's main beam.
 - Devices shall be installed only at fixed locations. Devices shall not operate while being moved or while inside a moving container.
 - Hand-held applications and residential use are prohibited.

2.1.6 Conformity with European directives

The CE marking on the device symbolizes the conformity with the following European directives:

Electromagnetic compatibility EMC 2014/30/EU	Directive of the European Parliament and of the Council on the harmonisation of the laws of the Member States relating to electromagnetic compatibility
Low voltage directive LVD 2014/35/EU	Directive of the European Parliament and of the Council on the harmonisation of the laws of the Member States relating to the making available on the market of electrical equipment designed for use within certain voltage limits
Atmosphère explosible ATEX 2014/34/EU	Directive of the European Parliament and the Council on the harmonisation of the laws of the Member States relating to equipment and protective systems intended for use in potentially explosive atmospheres
Pressure equipment directive PED 2014/68/EU	Directive of the European Parliament and of the Council on the harmonisation of the laws of the Member States relating to the making available on the market of pressure equipment
RED 2014/53/EU	Directive of the European Parliament and of the Council on the harmonisation of the laws of the Member States relating to the making available on the market of radio equipment and repeater Directive 1999/5/EC

The applicable directives can be found in the EC conformity declaration of the specific device.

2.1.7 Radio Equipment Directive (RED) 2014/53/EU

For the receiver test that covers the influence of an interferer signal to the device, the performance criterion has at least the following level of performance according to ETSI TS 103 361 [6]:

- Performance criterion: measurement value variation Δd over time during a distance measurement
- Level of performance: $\Delta d \leq \pm 50$ mm

2.1.8 CE Electromagnetic Compatibility (EMC) Conformity

This equipment has been tested and found to comply with the following EMC Standards:

EMC Standard	Title
CISPR 11:2009 + A1:2010/EN 55011:2009 + A1:2010, Class B	Limits and methods of measurements of radio disturbance characteristics of industrial, scientific, and medical (ISM) radio-frequency equipment.
EN 61326:2013 (IEC 61326:2012)	Electrical Equipment for Measurement, Control and Laboratory Use – Electromagnetic Compatibility.
EN61000-4-2:2009	Electromagnetic Compatibility (EMC) Part 4-2: Testing and measurement techniques – Electrostatic discharge immunity test.
EN61000-4-3:2006 + A1:2008 + A2:2010	Electromagnetic Compatibility (EMC) Part 4-3: Testing and measurement techniques – Radiated, radio-frequency, electromagnetic field immunity test 2006 + A1:2008 + A2:2010.
EN61000-4-4:2004 + A1:2010	Electromagnetic Compatibility (EMC) Part 4-4: Testing and measurement techniques – Electrical fast transient/burst immunity test.
EN61000-4-5:2006	Electromagnetic Compatibility (EMC) Part 4-5: Testing and measurement techniques – Surge immunity test.
EN61000-4-6:2010	Electromagnetic Compatibility (EMC) Part 4-6: Testing and measurement techniques – Immunity to conducted disturbances, induced by radio-frequency fields.
EN61000-4-8:2010	Electromagnetic Compatibility (EMC) Part 4-8: Testing and measurement techniques – Power frequency magnetic field immunity test.

2.2 Improper device modifications



Improper device modifications

Risk to personnel, system and environment can result from modifications to the device, particularly in hazardous areas.

- Only carry out modifications that are described in the instructions for the device. Failure to observe this requirement cancels the manufacturer's warranty and the product approvals.

2.3 Requirements for special applications

Due to the large number of possible applications, each detail of the described device versions for each possible scenario during commissioning, operation, maintenance or operation in systems cannot be considered in the instructions. If you need additional information not covered by these instructions, contact your local Siemens office or company representative.

Note

Operation under special ambient conditions

We highly recommend that you contact your Siemens representative or our application department before you operate the device under special ambient conditions as can be encountered in nuclear power plants or when the device is used for research and development purposes.

2.4 Use in hazardous areas

Qualified personnel for hazardous area applications

Persons who install, connect, commission, operate, and service the device in a hazardous area must have the following specific qualifications:

- They are authorized, trained or instructed in operating and maintaining devices and systems according to the safety regulations for electrical circuits, high pressures, aggressive, and hazardous media.
- They are authorized, trained, or instructed in carrying out work on electrical circuits for hazardous systems.
- They are trained or instructed in maintenance and use of appropriate safety equipment according to the pertinent safety regulations.

 **WARNING**

Loss of safety of device with type of protection "Intrinsic safety Ex i"

If the device has already been operated in non-intrinsically safe circuits or the electrical specifications have not been observed, the safety of the device is no longer ensured for use in hazardous areas. There is a danger of explosion.

- Connect the device with type of protection "Intrinsic safety" solely to an intrinsically safe circuit.
- Observe the specifications for the electrical data on the certificate.

Description

3.1 SITRANS LR250 overview

 WARNING
Loss of protection Danger to personnel, system and environment can result from improper use of the device. <ul style="list-style-type: none">• SITRANS LR250 is to be used only in the manner outlined in this manual, otherwise protection provided by the device may be impaired.

SITRANS LR250 is a 2-wire 25 GHz pulse radar level transmitter for continuous monitoring of liquids and slurries in storage vessels including high pressure and high temperature, to a range of 20 meters (66 feet). It is ideal for small vessels, material such as chemicals, food, beverages, solvents (including those of corrosive or aggressive nature), and low dielectric media.

The device consists of an electronic circuit coupled to a permanently attached antenna and either a threaded or flange type process connection.

This device supports PROFIBUS PA communication protocol, and SIMATIC PDM software. Signals are processed using Process Intelligence which has been field-proven in over 1,000,000 applications worldwide (ultrasonic and radar). This device supports acyclic communications from both a PROFIBUS Class I and Class II master.

3.1 SITRANS LR250 overview

Installing/mounting

4.1 Basic safety information

Note**Material compatibility**

Siemens can provide you with support concerning selection of sensor components wetted by process media. However, you are responsible for the selection of components. Siemens accepts no liability for faults or failures resulting from incompatible materials.

 **WARNING****Unsuitable connecting parts**

Risk of injury or poisoning.

In case of improper mounting, hot, toxic, and corrosive process media could be released at the connections.

- Ensure that connecting parts (such as flange gaskets and bolts) are suitable for connection and process media.

 **WARNING****Exceeded maximum ambient or process media temperature**

Danger of explosion in hazardous areas.

Device damage.

- Make sure that the maximum permissible ambient and process media temperatures of the device are not exceeded.

4.1.1 Unsuitable cables, cable glands and/or plugs

 WARNING
Unsuitable cables, cable glands and/or plugs Risk of explosion in hazardous areas. <ul style="list-style-type: none">• Use only cable glands/plugs that comply with the requirements for the relevant type of protection.• Tighten the cable glands in accordance with the torques specified in Installation instructions (Page 24).• Close unused cable inlets for the electrical connections.• When replacing cable glands, only use cable glands of the same type.• After installation, check that the cables are seated firmly.

 WARNING
Incorrect conduit system Risk of explosion in hazardous areas as result of open cable inlet or incorrect conduit system. <ul style="list-style-type: none">• In the case of a conduit system, mount a spark barrier at a defined distance from the device input. Observe national regulations and the requirements stated in the relevant approvals.

4.1.2 Pressure applications

 DANGER
Pressure applications Danger to personnel, system and environment will result from improper disassembly. <ul style="list-style-type: none">• Never attempt to loosen, remove, or disassemble process connection while vessel contents are under pressure.

 WARNING
Pressure applications Danger to personnel, system and environment can result from improper installation. <ul style="list-style-type: none">• Improper installation may result in loss of process pressure.

! WARNING**Exceeded maximum permissible operating pressure**

Danger of injury or poisoning.

The maximum permissible operating pressure depends on the device version. The device can be damaged if the operating pressure is exceeded. Hot, toxic and corrosive process media could be released.

- Make sure that the device is suitable for the maximum permissible operating pressure of your system.

Note

- The process connection tag shall remain with the process pressure boundary assembly. (The process pressure boundary assembly comprises the components that act as a barrier against pressure loss from the process vessel: that is, the combination of process connection body and emitter, but normally excluding the electrical enclosure). In the event the device package is replaced, the process connection tag shall be transferred to the replacement unit.
- Representative samples of this device have been hydrostatically tested, meeting or exceeding the requirement of the ASME Boiler and Pressure Vessel Code and the European Pressure Equipment Directive.

4.1.2.1 Pressure Equipment Directive, PED, 14/68/EU

Siemens Level Transmitters with flanged, threaded, or sanitary clamp type process mounts have no pressure-bearing housing of their own and, therefore, do not come under the Pressure Equipment Directive as pressure or safety accessories (see EU Commission Guideline A-08 and A-20).

4.2 Installation location requirements**! WARNING****Aggressive atmospheres**

Danger to personnel, system and environment can result from unsuitable environment.

- Provide an environment suitable to the housing rating and materials of construction.

NOTICE
Direct sunlight Device damage. The device can overheat or materials become brittle due to UV exposure. <ul style="list-style-type: none">• Protect the device from direct sunlight.• Make sure that the maximum permissible ambient temperature is not exceeded. Refer to the information in Technical data (Page 55).

4.3 Proper mounting

4.3.1 Mounting location

Note <ul style="list-style-type: none">• Correct location is key to a successful application.• Avoid reflective interference from vessel walls and obstructions by following guidelines in this chapter.
--

NOTICE
Incorrect mounting The device can be damaged, destroyed, or its functionality impaired through improper mounting. <ul style="list-style-type: none">• Before installing ensure there is no visible damage to the device.• Make sure that process connectors are clean, and suitable gaskets and glands are used.• Mount the device using suitable tools. Refer to the information in Installation instructions (Page 24).

Note

- On devices with a removable head, there is no limit to the number of times a device can be rotated without damage.
- When mounting, orient the front or back of the device towards the closest vessel wall or obstruction.
- Do not rotate the enclosure after programming and vessel calibration, otherwise an error may occur, caused by a polarity shift of the transmit pulse.

4.3.2 Nozzle design

Threaded PVDF antenna

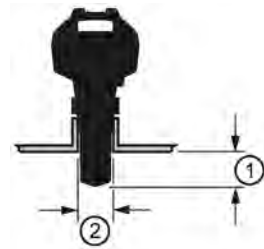

Stainless steel horn antenna

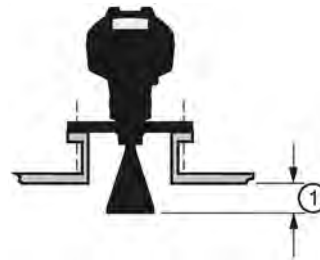

Polymeric lens versions

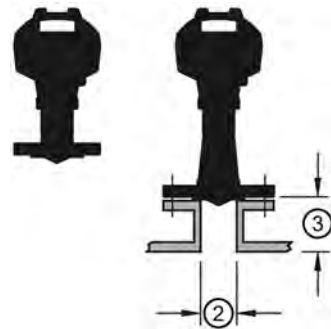

Hygienic encapsulated antenna (HEA)

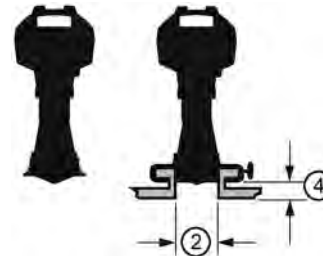

- ① Minimum clearance: 10 mm (0.4")
- ② Minimum diameter: 50 mm (2")
- ③ Maximum nozzle length
- ④ Maximum length/diameter ratio 1:1

- The end of the antenna must protrude a minimum of 10 mm (0.4") to avoid false echoes being reflected from the nozzle¹⁾.
- Minimum recommended nozzle diameter for the threaded PVDF antenna is 50 mm (2").
- An antenna extension (100 mm/3.93") is available for the horn antenna only.
- When installing the SITRANS LR250 with hygienic process connection, it is good hygienic practice to install the antenna in a nozzle that has a maximum length/diameter ratio of 1:1. For example, 2" (DN50) diameter nozzle should be no longer than 2" (50 mm).
- When removing any sanitary/hygienic clamp version of the HEA to clean the lens, ensure it is re-installed in the exact position it was removed from, to avoid re-commissioning the device.
- The maximum nozzle length for the polymeric lens versions is 500 mm (19.68").

¹⁾ Not applicable for polymeric lens versions or HEA

4.3.3 Nozzle location

- Avoid central locations on tall, narrow vessels
- Nozzle must be vertical and clear of imperfections

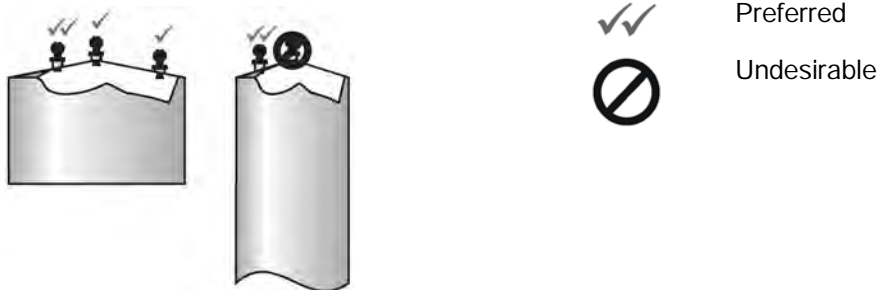

Beam angle

Note

- Beam width depends on antenna size and is approximate: see table below.
-

- Beam angle is the width of the cone where the energy density is half of the peak energy density.
- The peak energy density is directly in front of and in line with the antenna.
- There is a signal transmitted outside the beam angle, therefore false targets may be detected.

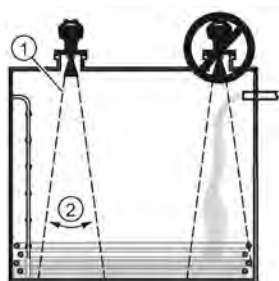

- ① Emission cone
- ② Beam angle

Emission cone type and beam angle

Antenna type	Antenna size		Beam angle
Horn	1.5"		19°
	2"		15°
	3"		10°
	4"		8°
Threaded PVDF			19°
	Process connection size	Process connection type	
PTFE flanged encapsulated	2"	Class 150 ASME B16.5	12.8°
	3, 4, 6"	Class 150 ASME B16.5	9.6°
	50A	10K JIS B 2220	12.8°
	80A/100A/150A	10K JIS B 2220	9.6°
	DN50	PN10/16 EN1092-1	12.8°
	DN80/DN100/DN150	PN10/16 EN1092-1	9.6°
Hygienic encapsulated	2"	Sanitary Clamp according to ISO 2852	12.8°
	3, 4"		9.6°
	DN50	Aseptic/Hygienic nozzle/slotted nut according to DIN 11864-1 [Form A]	12.8°
	DN80/DN100		9.6°
	DN50	Aseptic/Hygienic flanged according to DIN 11864-2 [Form A]	12.8°
	DN80/DN100		9.6°
	DN50	Aseptic/Hygienic Clamp according to DIN 11864-3 [Form A]	12.8°
	DN80/DN100		9.6°
	DN50	Hygienic nozzle/slotted nut according to DIN 11851	12.8°
	DN80/DN100		9.6°
Type F (50 mm) and Type N (68 mm)	Tuchenhagen Varivent	12.8°	

Emission cone

- Keep emission cone free of interference from obstructions such as ladders, pipes, I-beams, or filling streams.

Access for programming

- Provide easy access for viewing the display and programming via the handheld programmer.

Mounting on a Stillpipe or Bypass Pipe

See full operating instructions for further details.

4.4 Installation instructions

 WARNING
Pressure applications Danger to personnel, system and environment can result from improper installation. <ul style="list-style-type: none">• Improper installation may result in loss of process pressure.

 WARNING
Improper installation Danger to personnel, system and environment can result from improper installation. <ul style="list-style-type: none">• Installation shall only be performed by qualified personnel and in accordance with local governing regulations.

NOTICE
Device handling Damage to device may result from improper handling. <ul style="list-style-type: none">• Handle the device using the enclosure, not the process connection or tag, to avoid damage.• Take special care when handling the threaded PVDF and Hygienic or Flanged encapsulated antennas. Any damage to the antenna surface, particularly to the tip/lens, could affect performance. (For example, do not sit device on its lens antenna.)

Note

- For European Union and member countries, installation must be according to ETSI EN 302372.
- Refer to the device nameplate for approval information.

Note

Do not remove the PTFE or polypropylene lens. It is a critical component for operation.

Note

The outer part of the lens on the PTFE flanged encapsulated antenna version may not appear to lie flush before installation and this is normal. This will flatten after installation and will not impact the performance of the device.

4.4.1 Threaded versions

 WARNING
Pressure applications Danger of injury or poisoning. It may be necessary to use PTFE tape or other appropriate thread sealing compound, and to tighten the process connection beyond hand-tight. (The maximum recommended torque for Threaded versions is 40 N-m (30 ft.lbs.)

1. Before inserting the device into its mounting connection, check to ensure the threads are matching, to avoid damaging them.
2. Simply screw the device into the process connection, and hand tighten, or use a wrench.

4.4.2 Flanged versions

NOTICE
Improper materials The user is responsible for the selection of bolting and gasket materials (except for Flanged encapsulated antenna) which will fall within the limits of the process connection and its intended use, and which are suitable for the service conditions.

Special Instructions for PTFE flanged encapsulated antenna only

Note

- Use spring washers
 - Lens assembly acts as integral gasket, no other required
 - Use recommended torque values for tightening bolts
-

Flange bolting: recommended torque

Pressure class	Nominal pipe size (NPS)	Number of bolts	Recommended torque (Nm)
ASME B16.5, Class 150	2"	4	30 – 50
	3"		50 – 70
	4"	8	40 – 60
	6"		70 – 90
EN1092-1, PN16 / JIS B 2220, 10K	DN50/50A	4	30 – 50
	DN80/80A	8	
	DN100/100A	8	60 – 80
	DN150/150A		

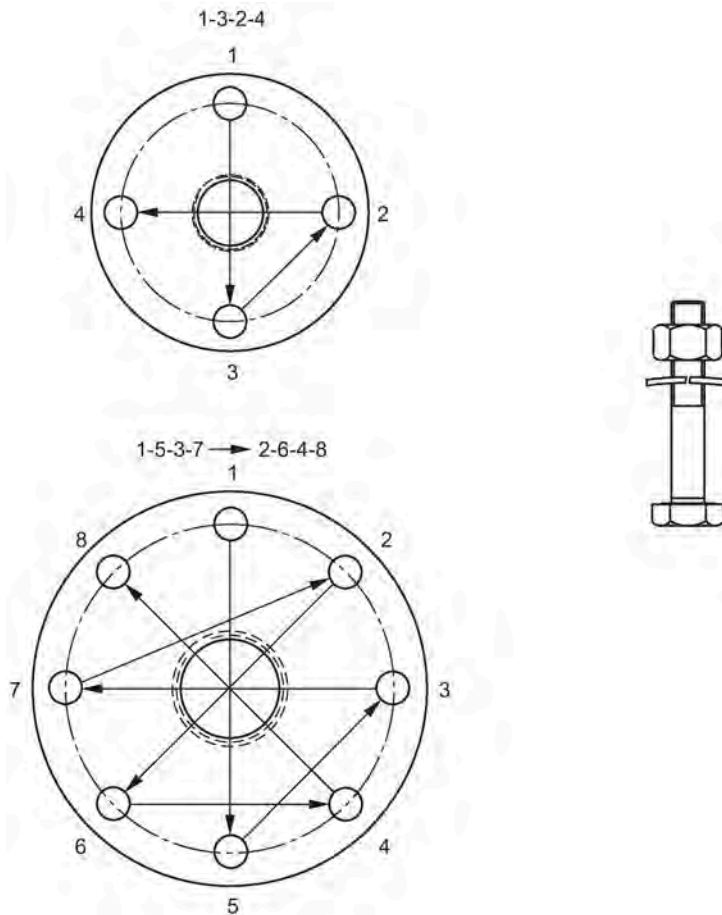

Flange bolting instructions:

1. Use cross-pattern sequence as shown.
2. Check uniformity of the flange gap.
3. Apply adjustments by selective tightening if required.
4. Torque incrementally until desired value is reached.
5. Check/re-torque after 4 to 6 hours.

Recommendations for flange bolting:

- Check bolts periodically, re-torque as required.
- Use new lens, O-ring and spring washers after removal from installation.
For instructions on replacing the lens, see Part replacement (Page 53).

For more details, see dimension drawings in full operating instructions.

4.4.3 Hygienic versions

 WARNING
Loss of sanitary approvals Loss of sanitary approvals can result from improper installation/mounting. <ul style="list-style-type: none">• Take special care when installing in hygienic or sanitary applications. Comply with installation/mounting guidelines to ensure cleanliness and the ability to keep the wetted parts in a position to be readily cleanable. (See relevant EHEDG/3A documentation - not supplied).

NOTICE
Loss of sanitary approvals <ul style="list-style-type: none">• For 3-A Sanitary Approved device installation where the customer tank process connection exists, a leak detection port of minimum 2.4 mm diameter must be provided at the lowest point in the process connection where leakage can occur.• If leakage is detected at any time while the device is installed, then the device process connection parts must be disassembled and thoroughly cleaned prior to gasket replacement and reassembly.

Note

- For Hygienic encapsulated antenna, the lens acts as a gasket/seal and should be used in conjunction with a cleanable seal as required by the specific process connections (for example, DIN 11864-3).

Hygienic encapsulated antenna leak detection port

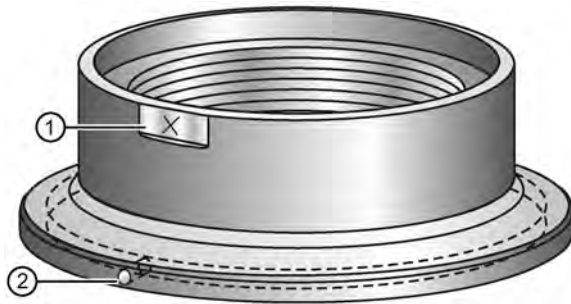

- ① Orientation mark for leak detection port
- ② Leak detection port

4.5 Disassembly

⚠ DANGER
Pressure applications Danger to personnel, system and environment will result from improper disassembly. <ul style="list-style-type: none">• Never attempt to loosen, remove, or disassemble process connection while vessel contents are under pressure.

⚠ WARNING
Incorrect disassembly The following risks may result from incorrect disassembly: <ul style="list-style-type: none">- Injury through electric shock- Risk through emerging media when connected to the process- Risk of explosion in hazardous area In order to disassemble correctly, observe the following: <ul style="list-style-type: none">• Before starting work, make sure that you have switched off all physical variables such as pressure, temperature, electricity etc. or that they have a harmless value.• If the device contains hazardous media, it must be emptied prior to disassembly. Make sure that no environmentally hazardous media are released.• Secure the remaining connections so that no damage can result if the process is started unintentionally.

Connecting

5.1 Basic safety information

NOTICE

Condensation in the device

Damage to device through formation of condensation if the temperature difference between transportation or storage and the mounting location exceeds 20 °C (36 °F).

- Before taking the device into operation, let the device adapt for several hours in the new environment.



WARNING

Missing PE/ground connection

Risk of electric shock.

Depending on the device version, connect the power supply as follows:

- **Power plug:** Ensure that the used socket has a PE/ground conductor connection. Check that the PE/ground conductor connection of the socket and power plug match each other.
- **Connecting terminals:** Connect the terminals according to the terminal connection diagram. First connect the PE/ground conductor.

5.2 Connecting SITRANS LR250

⚠ WARNING

Incorrect connection to power source

Risk to personnel, system and environment can result from improper power connection.

- The DC input terminals shall be supplied from a source providing electrical isolation between the input and output, in order to meet the applicable safety requirements of IEC 61010-1. For example, Class 2 or Limited Energy Source.
- All field wiring must have insulation suitable for rated voltages.

⚠ WARNING

Loss of protection

Loss of approvals can result from improper connection.

- Check the nameplate on your device, to verify the approval rating.
- Use appropriate cable entry seals to maintain IP or NEMA rating.
- See Wiring setups for hazardous area installations (Page 32).

NOTICE

Improper cables and conduit

- Separate cables and conduits may be required to conform to standard instrumentation wiring practices or electrical codes.

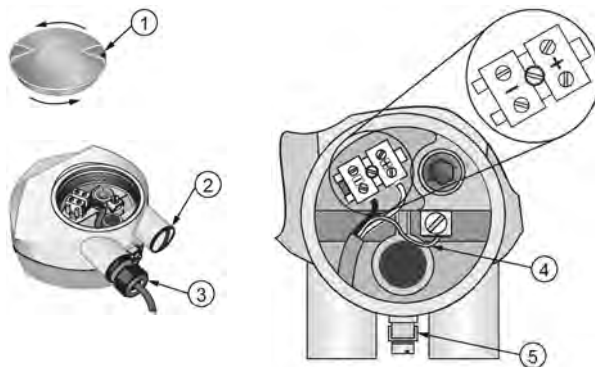

- | | |
|---|-------------------|
| ① Use a 2 mm Allen key to loosen the lid-lock set screw ^{c)} | ④ Cable shield |
| ② Plug (IP68) | ⑤ Ground terminal |
| ③ Optional cable gland ^{a)} ^{b)} (or NPT cable entry) ^{b)} | |

^{a)}May be shipped with the device.

^{b)}If cable is routed through conduit, use only approved suitable-size hubs for waterproof applications.

^{c)}Not applicable to 3-A Sanitary approved device.

Wiring instructions

1. Strip the cable jacket for approximately 70 mm (2.75") from the end of the cable, and thread the wires through the gland. (If cable is routed through conduit, use only approved suitable-size hubs for waterproof applications.)
 2. Connect the wires to the terminals as shown: SITRANS LR250 (PROFIBUS PA) is not polarity sensitive.
 3. Ground the device according to local regulations.
 4. Tighten the gland to form a good seal.
 5. Close the lid and secure the locking screw before programming and device configuration.
-

Note

Lid-lock set screw not applicable to 3-A Sanitary approved device.

Note

- PROFIBUS PA cable shield must be terminated at both ends of the cable for it to work properly.
 - If a Weidmüller or other current limiting junction box is connected to this device, please ensure that the current limit is set to 40 mA or higher.
 - Please refer to the PROFIBUS PA User and Installation Guidelines (order number 2.092) for information on installing PROFIBUS devices at:
PROFIBUS PA (<http://www.profibus.com/>)
-

Basic PLC configuration with PROFIBUS PA

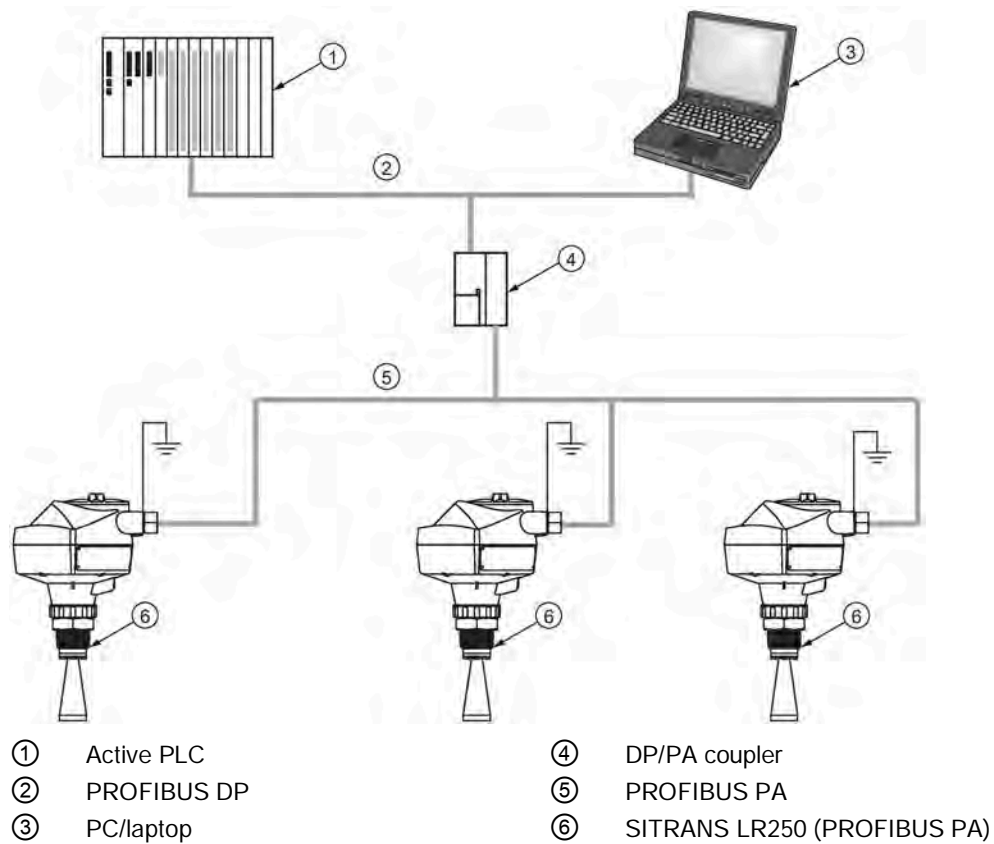

5.3 Wiring setups for hazardous area installations

In all cases, check the device nameplate, full operating instructions, and process connection tag to confirm the approval rating, and perform installation and wiring according to your local safety codes.

PLC configuration with PROFIBUS PA for hazardous areas

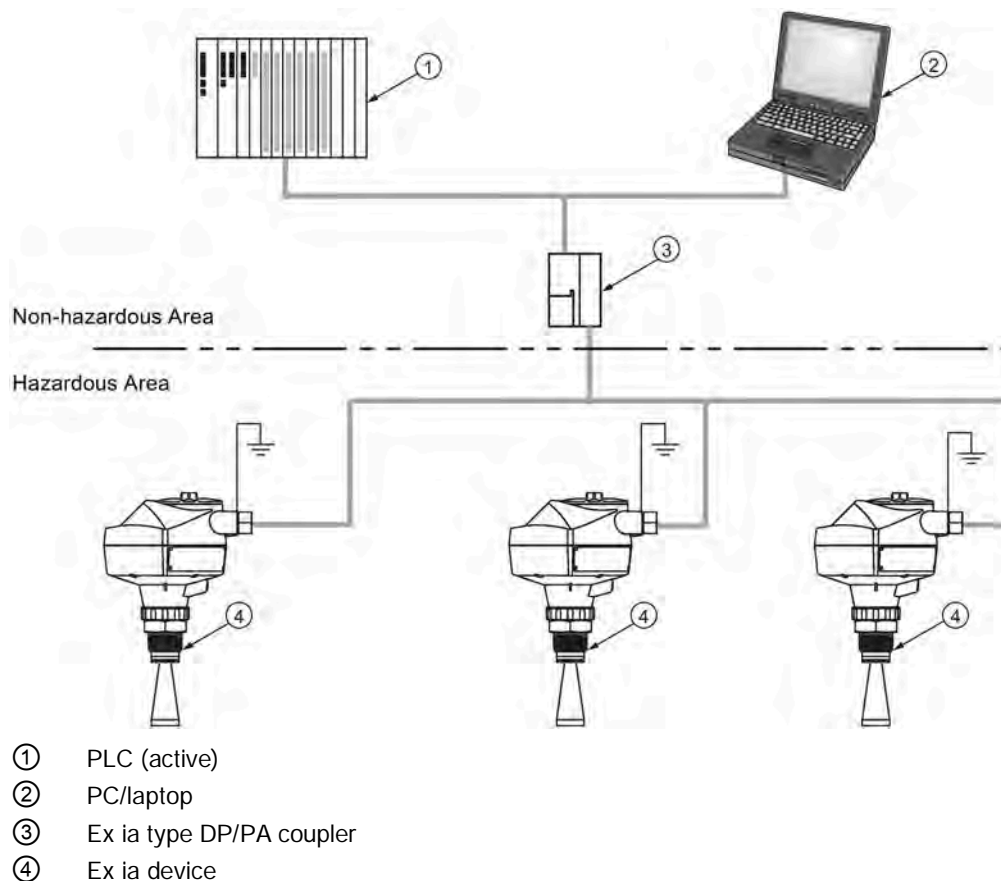

5.3.1 Intrinsically safe wiring

Device nameplate (ATEX/IECEX/INMETRO/RCM)

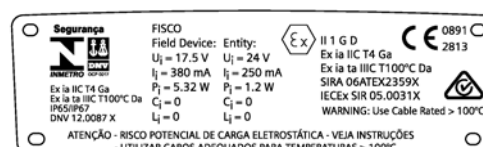
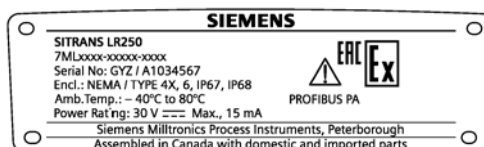

The ATEX and INMETRO certificates listed on the nameplate can be downloaded from our website:

Product page (<http://www.siemens.com/LR250>)

Go to **Support > Approvals / Certificates**.

The IECEx certificate listed on the nameplate can be viewed on the IECEx website. Go to: IECEx (<http://iecex.iec.ch/>)

Click on **Certified Equipment** and enter the certificate number **IECEX SIR 05.0031X**.

5.3.2 Non-sparking wiring

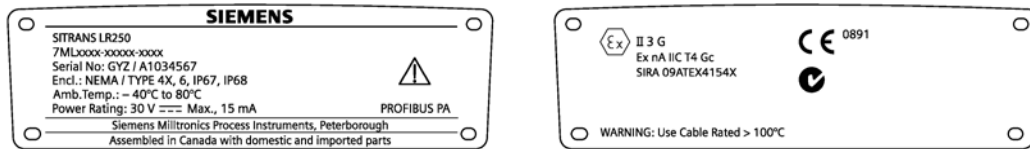

The ATEX certificate listed on the nameplate can be downloaded from our website:

Product page (<http://www.siemens.com/LR250>)

5.4 Instructions specific to hazardous area installations

5.4.1 (Reference European ATEX Directive 2014/34/EU)

The following instructions apply to equipment covered by certificate number SIRA 06ATEX2359X and SIRA 09ATEX4154X:

1. For use and assembly, refer to the main instructions.
2. The equipment is certified for use as Category 1GD equipment per SIRA 06ATEX2359X, and Category 3G equipment per SIRA 09ATEX4154X.
3. The equipment may be used with flammable gases and vapors with apparatus group IIC, IIB and IIA and temperature classes T1, T2, T3 and T4.
4. The equipment has a degree of ingress protection of IP67 and a temperature class of T100 °C and may be used with flammable dusts.
5. The equipment is certified for use in an ambient temperature range of -40 °C to +80 °C.
6. The equipment has not been assessed as a safety related device (as referred to by Directive 2014/34/EU, clause 1.5).
7. Installation and inspection of this equipment shall be carried out by suitably trained personnel in accordance with the applicable code of practice (EN 60079-14 and EN 60079-17 in Europe).
8. The equipment is non-repairable.
9. The certificate numbers have an 'X' suffix, which indicates that special conditions for safe use apply. Those installing or inspecting this equipment must have access to the certificates.
10. If the equipment is likely to come into contact with aggressive substances, then it is the responsibility of the user to take suitable precautions that prevent it from being adversely affected, thus ensuring that the type of protection is not compromised.
 - Aggressive substances: e.g. acidic liquids or gases that may attack metals, or solvents that may affect polymeric materials.
 - Suitable precautions: e.g. establishing from the material's data sheet that it is resistant to specific chemicals.

Special conditions for safe use (denoted by X after the certificate number)

- Parts of the enclosure may be non-conducting and may generate an ignition-capable level of electrostatic charge under certain extreme conditions. The user should ensure that the equipment is not installed in a location where it may be subjected to external conditions (such as high-pressure steam), which might cause a build-up of electrostatic charge on non-conducting surfaces.
- Aluminum, magnesium, titanium or zirconium may be used at the accessible surface of the equipment. In the event of rare incidents, ignition sources due to impact and friction sparks could occur. This shall be considered when the SITRANS LR250 PROFIBUS PA is being installed in locations that specifically require Equipment Protection level Ga or Da.
- The equipment shall be infallibly bonded according to the relevant code of practice.
- The end use must ensure that the explosion protection and ingress protection of IP64 is maintained at each entry to the enclosure by use of a blanking element or cable entry device that meets the requirements of the protection concepts type 'n' or increased safety 'e' or flameproof 'd'.

Commissioning

6.1 Basic safety information

 WARNING
Loss of explosion protection Risk of explosion when device is not properly commissioned If opening device <ul style="list-style-type: none">• Isolate from power. - or - <ul style="list-style-type: none">• Ensure that the atmosphere is explosion-free (hot work permit). Ensure device is properly closed before returning to operation.

6.2 Programming SITRANS LR250

- See Quick Start Wizard via the handheld programmer (Page 45).

Activating SITRANS LR250

Power up the device. SITRANS LR250 automatically starts up in Measurement mode. Press **Mode**  to toggle between Measurement and Program mode.

6.2.1 The LCD display

Measurement mode display

Normal operation



- ① Toggle indicator ^{a)} for analog input function blocks (AIFB 1 or AIFB 2)
- ② Identifies which AIFB is source of displayed value
- ③ Measured value (level, space, distance, or volume)
- ④ Units
- ⑤ Bar graph indicates level
- ⑥ Secondary region indicates on request ^{b)} electronics temperature, echo confidence, or distance
- ⑦ Text area displays status messages
- ⑧ Device status indicator, see Device status icons (Page 39)

^{a)} Press **UP** and **DOWN** arrow to switch.

^{b)} In response to a key press request. For details, see Handheld programmer (Part No. 7ML1930-1BK) (Page 39) for key functions in Measurement mode.

Fault present

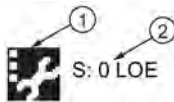

- ① Device status indicator, see Device status icons (Page 39)
- ② Text area displays a fault code and a status message

Program mode display

Navigation view



- ① Item band
- ② Menu bar
- ③ Current menu
- ④ Current item number
- ⑤ Current item

- A visible menu bar indicates the menu list is too long to display all items.
- A band halfway down the menu bar indicates the current item is halfway down the list.
- The depth and relative position of the item band on the menu bar indicates the length of the menu list, and approximate position of the current item in the list.
- A deeper band indicates fewer items.

Parameter view



Edit view

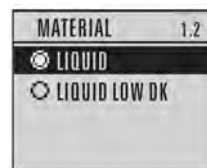

① Parameter name

② Parameter number

③ Parameter value/selection

6.2.2 Device status icons

For a complete list of the device status icons that appear on the LCD display, as well as what they mean, please refer to the **Diagnosing and Troubleshooting** section of the full operating instructions.

6.2.3 Handheld programmer (Part No. 7ML1930-1BK)

The programmer is ordered separately.









The handheld programmer used with this device contains lithium batteries that are non-replaceable.

Lithium batteries are primary power sources with high energy content designed to provide the highest possible degree of safety.

 WARNING
<p>Potential hazard</p> <p>Lithium batteries may present a potential hazard if they are abused electrically or mechanically. Observe the following precautions when handling and using lithium batteries:</p> <ul style="list-style-type: none"> • Do not short-circuit, recharge or connect with false polarity. • Do not expose to temperatures beyond the specified temperature range. • Do not incinerate. • Do not crush, puncture or open cells or disassemble. • Do not weld or solder to the battery's body. • Do not expose contents to water.

Key functions in measurement mode

Key	Function	Result
	Updates internal enclosure temperature reading.	New value is displayed in LCD secondary region.
	Updates echo confidence value.	
	Updates distance measurement	
	Mode opens PROGRAM mode	Opens the menu level last displayed in this power cycle, unless power has been cycled since exiting PROGRAM mode or more than 2 minutes have elapsed since PROGRAM mode was used. Then top level menu will be displayed.
	RIGHT arrow opens PROGRAM mode	Opens the top level menu.
 	UP or DOWN arrow toggles between AIFB 1 and AIFB 2.	Identifies which AIFB is the source of the displayed value.

6.2.4 Programming via the handheld programmer

Note

- While the device is in PROGRAM mode the output remains active and continues to respond to changes in the device.
- The device automatically returns to Measurement mode after a period of inactivity in PROGRAM mode (between 15 seconds and 2 minutes, depending on the menu level).

Parameter menus

Note

For the complete list of parameters with instructions, see the full operating instructions.

Parameters are identified by name and organized into function groups.

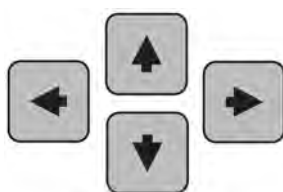

1. QUICK START

2. SETUP

2.1. IDENTIFICATION



.....

2.4. LINEARIZATION

2.4.1. VOLUME

2.4.1.1. VESSEL SHAPE

1. Enter PROGRAM mode

- Point the programmer at the display from a maximum distance of 300 mm (1 ft).
- **RIGHT arrow**  activates PROGRAM mode and opens menu level 1.
- **Mode**  opens the menu level last displayed in PROGRAM mode within the last 30 minutes, or menu level 1 if power has been cycled since then.

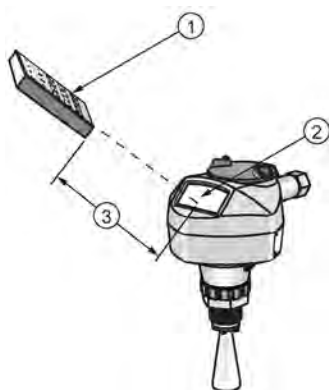

① Handheld programmer







② Display

③ Maximum distance: 300 mm (1 ft)



2. Navigating: key functions in Navigation mode

Note

- In navigation mode **ARROW keys** move to the next menu item in the direction of the arrow.
- For Quick Access to parameters via the handheld programmer, press Home , then enter the menu number, for example: **(2.4.1.) Volume**.

Key	Name	Menu level	Function
	UP or DOWN arrow	menu or parameter	Scroll to previous or next menu or parameter.
			
	RIGHT arrow	menu	Go to first parameter in the selected menu, or open next menu.
		parameter	Open Edit mode.
	LEFT arrow	menu or parameter	Open parent menu.
	Mode	menu or parameter	Change to MEASUREMENT mode.
	Home	menu or parameter	Open top level menu: menu 1.

3. Editing in PROGRAM mode

- Navigate to the desired parameter.
- Press **RIGHT arrow**  to open parameter view.
- Press **RIGHT arrow**  again to open **Edit** mode. The current selection is highlighted. Scroll to a new selection.
- Press **RIGHT arrow**  to accept it.

The LCD returns to parameter view and displays the new selection.

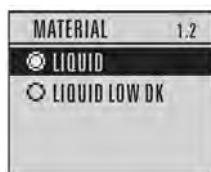



① Parameter name

② Parameter number

③ Current selection

4. Changing a numeric value

- Navigate to the desired parameter.
- Press **RIGHT arrow**  to open parameter view. The current value is displayed.
- Press **RIGHT arrow**  again to open **Edit** mode. The current value is highlighted.
- Key in a new value.
- Press **RIGHT arrow**  to accept it.

The LCD returns to parameter view and displays the new selection.

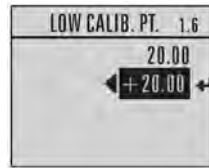
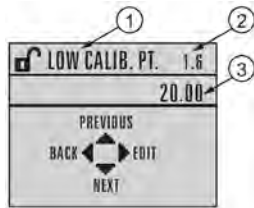









① Parameter name

② Parameter number

③ Current value

Key functions in edit mode

Key	Name	Function	
 	UP or DOWN arrow	Selecting options	Scrolls to item.
		Numeric editing	<ul style="list-style-type: none"> • Increments or decrements digits • Toggles plus and minus sign
	RIGHT arrow	Selecting options	<ul style="list-style-type: none"> • Accepts the data (writes the parameter) • Changes from Edit to Navigation mode
		Numeric editing	<ul style="list-style-type: none"> • Moves cursor one space to the right • or, with cursor on Enter sign, accepts the data and changes from Edit to Navigation mode
	LEFT arrow:	Selecting options	Cancels Edit mode without changing the parameter.
		Numeric editing	<ul style="list-style-type: none"> • Moves cursor to plus/minus sign if this is the first key pressed • or moves cursor one space to the left
	Clear	Numeric editing	Erases the display.
	Decimal point	Numeric editing	Enters a decimal point.
	Plus or minus sign	Numeric editing	Changes the sign of the entered value.
	Numeral	Numeric editing	Enters the corresponding character.







6.2.5 Quick Start Wizard via the handheld programmer

Parameter menus

Note

For the complete list of parameters with instructions, and Dimension drawings, see the full operating instructions.

1. Quick Start

- Point the programmer at the display from a maximum distance of 300 mm (1 ft), then press **RIGHT arrow**  to activate PROGRAM mode and open menu level 1.
- Press **RIGHT arrow**  twice to navigate to menu item 1.1 and open parameter view.
- Press **RIGHT arrow**  to open Edit mode or **DOWN arrow**  to accept default values and move directly to the next item.
- To change a setting, scroll to the desired item or key in a new value.
- After modifying a value, press **RIGHT arrow**  to accept it and press **DOWN arrow**  to move to the next item.
- Quick Start settings take effect only after you select **Yes** to **Apply changes** from previous steps.

1.1 Language

Selects the language to be used on the LCD and takes effect immediately.

Options	English, Deutsch, Français, Español
---------	-------------------------------------

1.2 Material

Selects the appropriate echo processing algorithms for the material [see **Position Detect (2.5.7.2.)** for more detail].

Options	*	LIQUID
		LIQUID LOW DK ^{a)} (low dielectric liquid – CLEF algorithm enabled)

^{a)} $dK < 3.0$

1.3 Response Rate

Sets the reaction speed of the device to measurement changes in the target range. Use a setting just faster than the maximum filling or emptying rate (whichever is greater).

Options	Response Rate (2.3.8.1.)	Fill rate (2.3.8.2.)/Empty rate per Minute (2.3.8.3.)
	SLOW	0.1 m/min (0.32 ft/min)
	MED	1.0 m/min (3.28 ft/min)
	FAST	10.0 m/min (32.8 ft/min)

1.4 Units

Sensor measurement units.

Options	m, cm, mm, ft, in.
---------	--------------------

1.5 Operating mode

Operation	Description
NO SERVICE	Measurement and associated loop current are not updated, and the device defaults to Fail-safe mode ^{a)} .
LEVEL	Distance to material surface referenced from Low Calibration Point
SPACE	Distance to material surface referenced from High Calibration Point
DISTANCE	Distance to material surface referenced from Sensor reference point

^{a)} See **Material Level (2.5.1.)** for more detail.

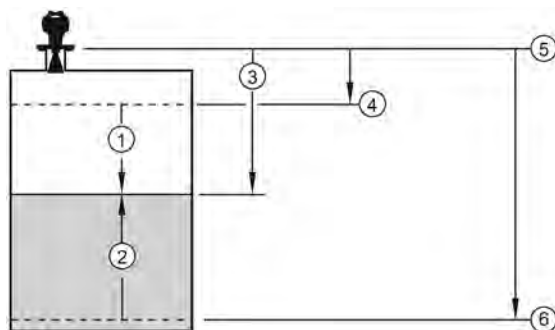

- ① Space
- ② Level
- ③ Distance
- ④ High Calibration Point (process full level)
- ⑤ Sensor reference point ^{a)}
- ⑥ Low Calibration Point (process empty level)

^{a)} The point from which High and Low Calibration points are referenced: see **Dimension Drawings**.

1.6 Low Calibration Point

Distance from Sensor Reference to Low Calibration Point: usually process empty level. (See **Operating mode** for an illustration.)

Values	Range: 0.00 to 20.00 m
--------	------------------------

1.7 High Calibration Point

Distance from Sensor reference point to High Calibration Point: usually process full level. (See **Operating mode** for an illustration.)

Values	Range: 0.00 to 20.00 m
--------	------------------------

1.8 Apply? (Apply changes)

Options	YES, NO, DONE (Display shows DONE when Quick Start is successfully completed.)
---------	--

Press **Mode**  to return to **Measurement** mode. SITRANS LR250 is now ready to operate.

Remote operation

7.1 SITRANS Communications: PROFIBUS PA

- You will need the full operating instructions to acquire the list of applicable parameters.
- We recommend that you use SIMATIC Process Device Manager (PDM) to program your device.

Service and maintenance

8.1 Basic safety information

 WARNING
Impermissible repair of the device <ul style="list-style-type: none"> • Repair must be carried out by Siemens authorized personnel only.

 CAUTION
Releasing button lock <p>Improper modification of parameters could influence process safety.</p> <ul style="list-style-type: none"> • Make sure that only authorized personnel may cancel the button locking of devices for safety-related applications.

8.2 Cleaning

The radar device requires no cleaning under normal operating conditions.

Under severe operating conditions, the antenna may require periodic cleaning. If cleaning becomes necessary:

- Note the antenna material and the process medium, and select a cleaning solution that will not react adversely with either.
- Remove the device from service and wipe the antenna clean using a cloth and suitable cleaning solution.

NOTICE
Penetration of moisture into the device <p>Device damage</p> <ul style="list-style-type: none"> • Make sure when carrying out cleaning and maintenance work that no moisture penetrates the inside of the device.

 WARNING
Electrostatic charge Danger of explosion in hazardous areas if electrostatic charges develop, for example, when cleaning plastic surfaces with a dry cloth. <ul style="list-style-type: none">• Prevent electrostatic charging in hazardous areas.

8.3 Maintenance and repair work

The device is maintenance-free. However, a periodic inspection according to pertinent directives and regulations must be carried out.

An inspection can include, for example, check of:

- Ambient conditions
- Seal integrity of the process connections, cable entries, and cover
- Reliability of power supply, lightning protection, and grounds

 WARNING
Maintenance during continued operation in a hazardous area There is a risk of explosion when carrying out repairs and maintenance on the device in a hazardous area. <ul style="list-style-type: none">• Isolate the device from power. - or - <ul style="list-style-type: none">• Ensure that the atmosphere is explosion-free (hot work permit).

 WARNING
Humid environment Risk of electric shock. <ul style="list-style-type: none">• Avoid working on the device when it is energized.• If working on an energized device is necessary, ensure that the environment is dry.• Make sure when carrying out cleaning and maintenance work that no moisture penetrates the inside of the device.

8.3.1 Unit repair and excluded liability

All changes and repairs must be done by qualified personnel, and applicable safety regulations must be followed. Please note the following:

- The user is responsible for all changes and repairs made to the device.
- All new components must be provided by Siemens.
- Restrict repair to faulty components only.
- Do not re-use faulty components.

8.3.2 Part replacement

If the antenna, lens, secondary O-ring, and spring washers require replacement due to damage or failure, they may be replaced without the need for re-calibration if of the same type and size.

Replacing the antenna

Changing to a different antenna type may be performed by a Siemens authorized repair center or personnel.

If the electronics or enclosure require replacement due to damage or failure, please ensure the correct antenna version is used, otherwise a re-calibration will need to be performed by Siemens authorized personnel.

Replacing the lens

1. Remove existing lens by turning it counter-clockwise until it separates from the unit.
2. Replace the O-ring between the lens and process connection with a new one.
3. Carefully thread the replacement lens, and turn it clockwise until resistance is encountered.
Do not over-tighten the lens, as this will permanently damage it.
4. For flange installation instructions, see Flanged versions (Page 25).

Note

After installation of the new lens onto the flanged encapsulated antenna version and before mounting on the vessel/tank, some lenses may not appear to lie flush on the device, but this is normal and will not impact performance.

See full operating instructions for part numbers.

8.4 Disposal



Devices described in this manual should be recycled. They may not be disposed of in the municipal waste disposal services according to the Directive 2012/19/EC on waste electronic and electrical equipment (WEEE).

Devices can be returned to the supplier within the EC, or to a locally approved disposal service for eco-friendly recycling. Observe the specific regulations valid in your country.

Further information about devices containing batteries can be found at: Information about battery / product return (WEEE)

[\(https://support.industry.siemens.com/cs/document/109479891/\)](https://support.industry.siemens.com/cs/document/109479891/)

8.5 Return procedure

8.5.1 Return procedure

Enclose the bill of lading, return document and decontamination certificate in a clear plastic pouch and attach it firmly to the outside of the packaging. Any devices/replacement parts which are returned without a decontamination declaration will be cleaned at your expense before further processing. For further details, refer to the operating instructions.

Technical data

Note

Device specifications

Siemens makes every attempt to ensure the accuracy of these specifications but reserves the right to change them at any time.

For a complete listing, including Approvals, see the full operating instructions.

Note

- The maximum temperature is dependent on the process connection, antenna materials, and vessel pressure. For more detailed information see **Maximum Process Temperature Chart**, and **Process Pressure/Temperature derating curves** in the full operating instructions.
 - Process temperature and pressure capabilities are dependent upon information on the process connection tag. The reference drawing listed on the tag is available for download from our website under **More information > Installation drawings > Level Measurement > SITRANS LR250:**
Product page (<http://www.siemens.com/LR250>)
 - Process connection drawings are also available on the **Installation Drawings** page.
 - Signal amplitude increases with horn diameter, so use the largest practical size.
 - Optional extensions can be installed below the threads.
-



- ① Ambient temperature (surrounding enclosure)
-40 to +80 °C (-40 to +176 °F)
- ② Device nameplate
- ③ Process connection tag (laser etching on antenna body replaces tag on Flanged and Hygienic encapsulated antennas)
- ④ Device tag (optional)

9.1 Power

	Bus powered	Per IEC 61158-2 (PROFIBUS PA)
	Current consumed	15 mA

Product documentation and support

A.1 Product documentation

Process instrumentation product documentation is available in the following formats:

- Certificates (<http://www.siemens.com/processinstrumentation/certificates>)
- Downloads (firmware, EDDs, software) (<http://www.siemens.com/processinstrumentation/downloads>)
- Catalog and catalog sheets (<http://www.siemens.com/processinstrumentation/catalogs>)
- Manuals (<http://www.siemens.com/processinstrumentation/documentation>)

You have the option to show, open, save, or configure the manual.

- "Display": Open the manual in HTML5 format
- "Configure": Register and configure the documentation specific to your plant
- "Download": Open or save the manual in PDF format
- "Download as html5, only PC": Open or save the manual in the HTML5 view on your PC

You can also find manuals with the Mobile app at Industry Online Support (<https://support.industry.siemens.com/cs/ww/en/sc/2067>). Download the app to your mobile device and scan the device QR code.

Product documentation by serial number

Using the PIA Life Cycle Portal, you can access the serial number-specific product information including technical specifications, spare parts, calibration data, or factory certificates.

Entering a serial number

1. Open the PIA Life Cycle Portal (<https://www.pia-portal.automation.siemens.com>).
2. Select the desired language.
3. Enter the serial number of your device. The product documentation relevant for your device is displayed and can be downloaded.

To display factory certificates, if available, log in to the PIA Life Cycle Portal using your login or register.

Scanning a QR code

1. Scan the QR code on your device with a mobile device.
2. Click "PIA Portal".

To display factory certificates, if available, log in to the PIA Life Cycle Portal using your login or register.

A.2 Technical support

Technical support

If this documentation does not completely answer your technical questions, you can enter a Support Request (<http://www.siemens.com/automation/support-request>).

Additional information on our technical support can be found at Technical Support (<http://www.siemens.com/automation/csi/service>).

Service & support on the Internet

In addition to our technical support, Siemens offers comprehensive online services at Service & Support (<http://www.siemens.com/automation/service&support>).

Contact

If you have further questions about the device, contact your local Siemens representative at Personal Contact (<http://www.automation.siemens.com/partner>).

To find the contact for your product, go to "all products and branches" and select "Products & Services > Industrial automation > Process instrumentation".

Contact address for business unit:

Siemens AG
Digital Industries
Process Automation
Östliche Rheinbrückenstr. 50
76187 Karlsruhe, Germany

Index

A

ambient temperature, 55
antenna
 replacement, 53

B

bolting instructions, 26

C

cables
 requirements, 30
Catalog
 catalog sheets, 57
Certificates, 57
cleaning
 instructions, 51
conduits
 requirements, 30
configuration
 PLC with PROFIBUS PA, 32
Customer Support, (Refer to Technical support)

D

device nameplate
 Intrinsically Safe (ATEX/IECEX), 33
Disassembly, 28
Disposal, 54
Downloads, 57

E

edit mode
 handheld programmer, 41
 key functions, 44
enclosure
 opening, 30

F

flange
 bolting instructions, 26
function keys
 edit mode, 44
 navigation mode, 42
Function keys
 measurement mode, 40

H

handheld programmer
 edit mode, 42, 44
 measurement mode, 40
 navigation, 42, 42
 programming, 41
Hazardous area
 Qualified personnel, 13
hazardous area installations
 instructions, 34
 wiring requirements, 32
Hotline, (Refer to Support request)

I

installation
 hazardous area requirements, 32
 requirements, 24
 warnings and notes, 24

K

key functions
 edit mode, 44
 navigation mode, 42

L

LCD display
 measurement mode, 37
lens
 replacement, 53
lid-lock set screw, 30

Lithium batteries
 Safety, 40
Local User Interface (LUI), 38
LUI (Local User Interface
 contrast adjustment, 38

M

maintenance
 repairs, 51
 replacing antenna, 53
 replacing lens, 53
Maintenance, 52
Manuals, 57
Modifications
 correct usage, 13
 improper, 13
mounting
 handheld programmer access, 24
 housing construction, 20
 nozzle design, 21
 nozzle location, 22

N

nameplate, 55
 Intrinsically Safe (ATEX/IECEX), 33

O

overview, 15

P

PED (Pressure Equipment Directive), 19
power source
 requirements, 30
pressure applications, 19
 Pressure Equipment Directive, 19
programmer
 handheld, 39
programming
 via the handheld programmer, 41
programming LR250
 enter program mode, 41
 via handheld programmer, 41

Q

Qualified personnel, 13

R

repair
 cautions, 53
 excluded liability, 53
Return procedure, 54

S

Scope of delivery, 6
Service, 58
Service and support
 Internet, 58
settings
 adjust parameters via LUI, 44
Support, 58
Support request, 58

T

tag
 process connection, 55
Technical data, 55
Technical support, 58
 partner, 58
 personal contact, 58
temperature
 ambient, 55
 process, 55

W

Warranty, 7
wiring
 cables, 30
 hazardous areas, 32