

# Instruction manual Flow sensor IVD 500

**with Display, 4 ... 20 mA and Pulse output (galv. isolated)**

**Stationary and mobile  
flow and consumption measurement for compressed air and gases**



**II. Table of content**

**II. Table of content ..... 2**

**1 Intended use..... 4**

**2 Safety instructions..... 4**

**3 Instruments description ..... 5**

**4 Technical data..... 6**

**5 Installation..... 7**

**5.1 Pipe/tube requirements ..... 7**

**5.2 Inlet / outlet runs ..... 7**

**5.3 Installation IVD 500 ..... 8**

        5.3.1 ½" welded nipple with ball valve ½" ..... 8

        5.3.2 Spot drilling collar with ball valve ..... 8

**5.4 Installation of the Sensor ..... 9**

        5.4.1 Mounting IVD 500 onto the ball valve ..... 9

        5.4.2 Installation angle for locations that potentially hold water ..... 10

**5.5 Display Head Position ..... 10**

**6 Commissioning ..... 11**

**6.1 Zero Point Adjustment..... 11**

**6.2 4... 20 mA Analogausgang..... 11**

**7 Measuring ranges ..... 12**

**7.1 Maximum Flow ranges „High speed“ ..... 13**

**7.2 Maximum Flow ranges „Ultra speed“ ..... 14**

**8 Dimension ..... 15**

**9 Electrical wiring ..... 16**

**9.1 Modbus RTU, 4..20mA, Pulse or MBus ..... 16**

**9.2 Ethernet (optional PoE) ..... 17**

<b>10</b>	<b>Operation.....</b>	<b>18</b>
<b>10.1</b>	<b>Initialization .....</b>	<b>19</b>
<b>10.2</b>	<b>Main menu .....</b>	<b>19</b>
<b>10.3</b>	<b>Settings .....</b>	<b>20</b>
10.3.1	Sensor Setup .....	21
10.3.1.1	Input / change tube diameter.....	21
10.3.1.2	Input / change consumption counter .....	22
10.3.1.3	Definition of the units for flow, velocity, temperature and pressure .....	22
10.3.1.4	Definition of the reference conditions .....	23
10.3.1.5	Setting of Zeropoint and Low-flow cut off .....	25
10.3.2	Modbus Settings .....	26
10.3.2.1	Modbus RTU Setup .....	26
10.3.2.2	Modbus TCP (Optional).....	27
10.3.2.2.1	Network Setup DHCP.....	27
10.3.2.2.2	Network Settings static IP.....	28
10.3.2.2.3	Modbus TCP Settings.....	29
10.3.2.3	Modbus Settings Register (2001...2005) .....	30
10.3.2.4	Values Register (1001 ...1500).....	30
10.3.3	Pulse /Alarm.....	32
10.3.3.1	Pulse output.....	32
10.3.4	User Setup .....	33
10.3.4.1	Password .....	33
10.3.4.2	Language.....	33
10.3.4.3	Display / Touch .....	34
10.3.5	Advanced .....	34
10.3.6	4 -20mA .....	35
10.3.7	IVD 500 Info .....	37
<b>10.4</b>	<b>MBus.....</b>	<b>37</b>
10.4.1	Default Settings communication .....	37
10.4.2	Default values transmitted .....	37
<b>11</b>	<b>Status / Error messages .....</b>	<b>38</b>
<b>11.1</b>	<b>Status messages .....</b>	<b>38</b>
<b>11.2</b>	<b>Error messages .....</b>	<b>39</b>
<b>12</b>	<b>Maintenance .....</b>	<b>40</b>
<b>13</b>	<b>Re-Calibration .....</b>	<b>40</b>
<b>14</b>	<b>Spare parts and repair.....</b>	<b>40</b>
<b>15</b>	<b>Calibration.....</b>	<b>40</b>
<b>16</b>	<b>Warranty.....</b>	<b>40</b>

### 1 Intended use

The IVD 500 consumption sensor is used for continuous flow measurements, based on a dynamic pressure / differential pressure measurement.

The IVD 500 consumption sensor is designed and constructed exclusively for the intended purpose described here and may only be used accordingly.

The user must check whether the instrument is suitable for the selected application. It must be ensured that the medium is compatible with the wetted parts. The technical data listed in the data sheet are binding.

Improper handling or operation outside the technical specifications is not permitted. Claims of any kind based on improper use are excluded.

### 2 Safety instructions



**Please read carefully before starting the device!**

Warning:

Do not exceed the pressure range of 16 bar.

Over 10 bar we recommend using the high-pressure protection for a safe installation and removal.

Observe the measuring ranges of the sensor!

Overheating destroys the sensor.

Observe the admissible storage and transportation temperature as well as the permitted operating temperature (e.g. protect the instrument from direct insolation).

Always observe the direction of flow when positioning the sensor!

The safety ring at the sensor head must always remain undamaged and sit correctly in the destined slot.

The screwed fixture must be pressure tight.

The adapter sleeve must be tightened with a torque of 20 to 30 Nm.

It is necessary to avoid condensation on the sensor element or water drops in the measuring air as they may cause faulty.

The values of the inlet and outlet sections must not fall below the specified minimum values as this causes increased deviations in the measuring results.

The manufacturer cannot be held liable for any damage that occurs because of non-observance or non-compliance with these instructions. Should the device be tampered with in any matter other than a procedure, which is described and specified in the manual, the warranty is cancelled and the manufacturer is exempt from liability.

The device is destined exclusively for the described application.

ICS offers no guarantee for the suitability for any other purpose and is not liable for errors that may have slipped into this operation manual. ICS is also not liable for consequential damage resulting from the delivery, capability or use of this device.

We offer you to take back the instruments of the instruments family IVD 500 which you would like to dispose of.

Qualified employees from the measurement and control technology branch should only carry out adjustments and calibrations.

### 3 Instruments description

The IVD 500 is a compact consumption counter for compressed air and gases.

#### Special features:

- Optimum accuracy due to compact design
- Integrated Display showing Flow, consumption, velocity and temperature
- Input inner tube diameter via display keys
- Units free selectable.  $\text{m}^3/\text{h}$ ,  $\text{m}^3/\text{min}$ ,  $\text{l}/\text{min}$ ,  $\text{l}/\text{s}$ ,  $\text{kg}/\text{h}$ ,  $\text{kg}/\text{min}$ ,  $\text{kg}/\text{s}$ ,  $\text{cfm}$
- Modbus RTU (RS485) Interface
- Analogoutput 4..20mA
- Pulse output galv. isolated.

#### Service Software

- Analogoutput 4...20 mA scaleabler
- Selection of gas type (Air, Nitrogen, Argon, Nitrous oxide,  $\text{CO}_2$ , Oxygen, Natural gas)
- Read out Service data
- Sensordiagnose

## 4 Technical data

<b>Measurement:</b>	<b>Flow, Consumption, Velocity and Pressure</b>
<b>Reference:</b>	Standard settings ex works: DIN 1945, ISO 1217 at 20°C and 1000 mbar other standards can be adjusted by Display keys (optional) or means of the Service Software.
<b>Selectable Units:</b>	<b>m<sup>3</sup>/h</b> (Standard settings ex- factory) m <sup>3</sup> /min, l/min, l/s, ft/min, cfm, m/s, kg/h, kg/min, kg/s, °C, °F
<b>Measuring principle:</b>	Differential pressure
<b>Sensor:</b>	Pressure, NTC
<b>Measuring medium:</b>	Air, gases
<b>Operating temperature:</b>	-20 ... 70°C housing
<b>Medium temperature:</b>	-30 ... 180°C probe tube
<b>Relative humidity for measuring medium:</b>	< 95 % r.H (no condensation on the sensor element allowed)
<b>Operating pressure:</b>	up to 20 bar
<b>Power supply:</b>	18 to 36 VDC
<b>Power consumption:</b>	max. 5W
<b>Digital output:</b>	RS 485 (Modbus RTU) <b>Optional:</b> MBus, Ethernet (PoE)
<b>Analog output:</b>	4...20 mA (see tables page 13 -18), max. burden < 500 Ohm
<b>Pulse output:</b>	pulse output potential free (dry contact) passive: max. 48Vdc, 150mA 1 pulse pro m <sup>3</sup> resp. pro l, Valency adjustable with the display keys
<b>Accuracy:</b>	± 1,5 % m.v.*, ± 0,3 % f.s. (20..224m/s)* ± 1,5 % m.v (>224 m/s)
<b>Display:</b>	optional TFT 1.8" Resolution 220 x 176
<b>Mounting thread:</b>	G ½", optional ½" NPT
<b>Material:</b>	Stainless steel 1.4301 / 1.4404
<b>Protection class</b>	IP65

\* m.v. = measured values  
f.s. = full scale

## 5 Installation

### 5.1 Pipe/tube requirements

- Correctly sized gaskets
- Correct aligned flanges and gaskets
- Diameter mismatch at the pipe junctions should be avoided but must be less than 1mm. For further information see ISO 14511
- Ensure clean pipes after installation
- .

### 5.2 Inlet / outlet runs

In order to maintain the accuracy stipulated in the data sheets, the sensor must be inserted in the centre of a straight pipe section with an undisturbed flow progression.

An undisturbed flow progression is achieved if the sections in front of the sensor (inlet) and behind the sensor (outlet) are sufficiently long, straight and without any obstructions such as edges, seams, curves etc.

Therefore, it is necessary to ensure the recommended inlet and outlet runs.

**Table Inlet / Outlet runs**

Flow obstruction before the measurement section	Min length Inlet run (L1)	Min length Outlet run (L2)
Slight curve (elbow < 90°)	12 x D	5 x D
Reduction (Pipe narrows to the measurement section)	15 x D	5 x D
Expansion (Pipe expands to the measurement section)	15 x D	5 x D
90° elbow or T-piece	15 x D	5 x D
2x elbow á 90° in einer Ebene	20 x D	5 x D
2x elbow á 90° 3-dimensional	35 x D	5 x D
Control valve	45 x D	5 x D

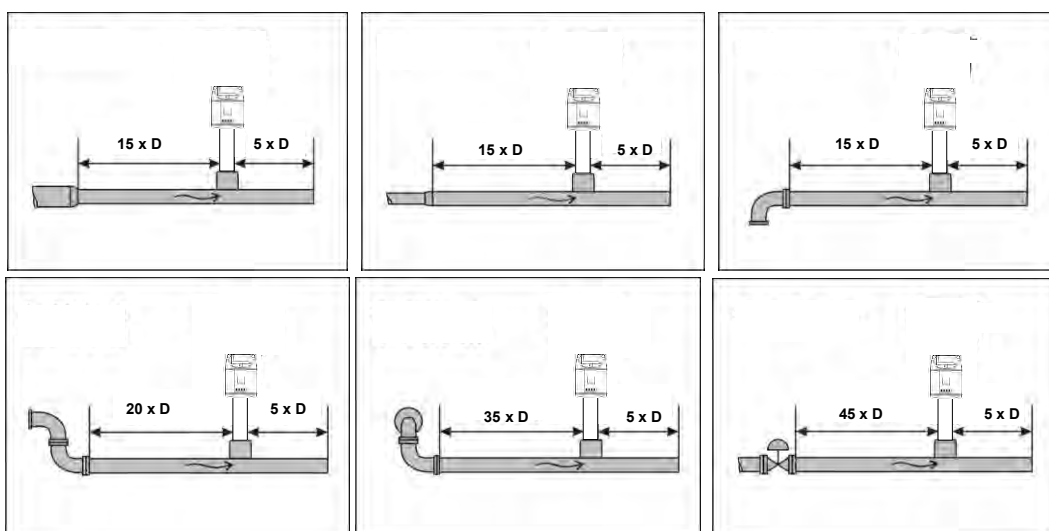

The values represent the min. lengths. In case the min. inlet / outlet runs could not be ensured, it must be expected to get increased or significant deviations of the measurement values.

## 5.3 Installation IVD 500

The installation of the sensor is done via a ball valve 1/2".

If no valid measuring point with a ball valve 1/2" is available there are following ways to set up a measuring point.

### 5.3.1 1/2" welded nipple with ball valve 1/2"



**Important:**

Ensure that the system is in shut down, ie. depressurized.

**Note for installation with ball valve**

Ball valve R 1/2", DN 15

Passage ball valve: Minimum Ø15 mm

### 5.3.2 Spot drilling collar with ball valve



In case the system could not be shut down, means to be set depressurized, there could be used the ICS spot drilling collar (Order-No. 0530 1108) and drilling jig (Order-No. 0530 1108) to drill through the ball valve.



## 5.4 Installation of the Sensor

### 5.4.1 Mounting IVD 500 onto the ball valve

#### valve

- Assembly is carried out by inserting the connection thread with gasket. (G1/2" thread, SW 32) into the ball valve with 1/2" internal thread. The sensor has be tighten by hand as far as possible and then tighten with stipulated torque of 25-30 Nm. It must be ensured that the installation is pressure-tight.



- The sensor is then inserted to the required immersion depth (sensor tip in the middle of pipe) and aligned according to the direction of the airflow. A depth scale engraved on the probe tube, a flow alignment arrow and an aligning device will be of help for you. Once the sensor has been aligned the adapter sleeve must be tighten with stipulated torque of 20-30Nm (SW 17).

**Attention:** Alignment of the sensor must not be modified when tightening the connection thread and adapter sleeve. In this case, please check the immersion depth and alignment again and correct it if necessary. The angular deviation should not be greater than  $\pm 2^\circ$  in relation to ideal position as otherwise the measuring accuracy will decrease.

Calculation mounting depth:

Alignment flow direction

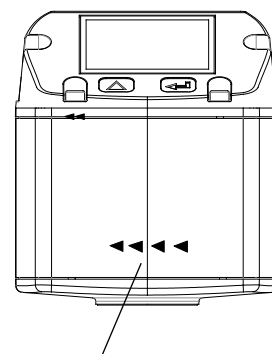
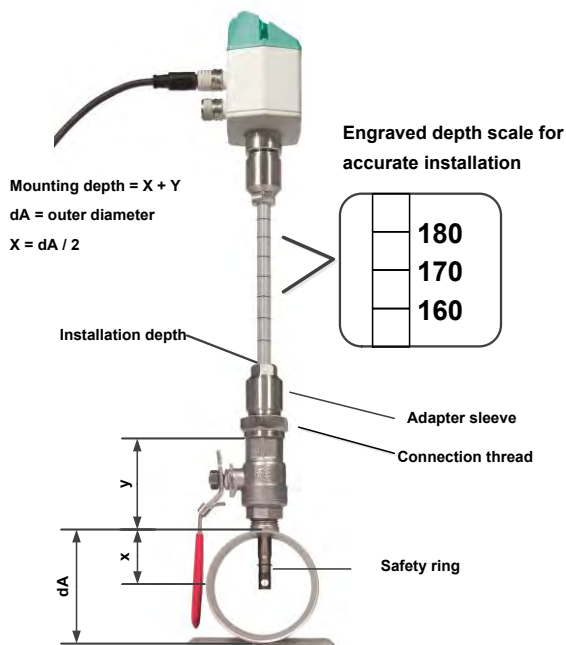

Indication flow direction

#### Sensor alignment

A max. angle deviation of  $\pm 2^\circ$  is permitted to ensure measured values..



correct

### 5.4.2 Installation angle for locations that potentially hold water



Location that potentially hold water should be avoided !

- It is recommended to install the IVD 500 at an angle of 15 degrees (see picture). This allows condensate or water to drip off in the event that it is present.
- Installations in risers are basically possible.
- **Not permitted installation of the IVD 500:**
  - upside down sensor installation as condensate / water may no longer drain off.
  - An installation from above (vertical) is also not permitted as water penetration leads to measurement errors.
  - An installation in downpipes

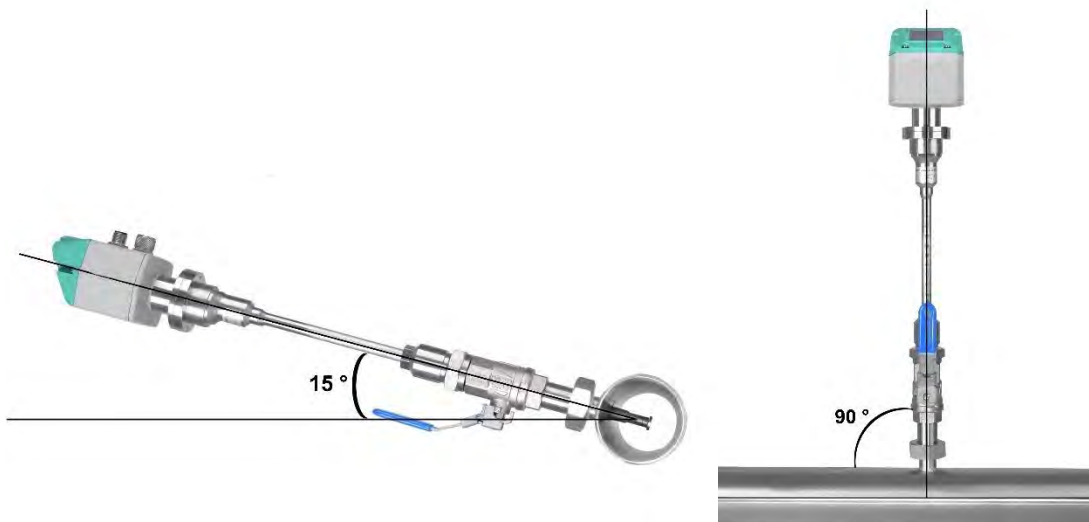

### 5.5 Display Head Position

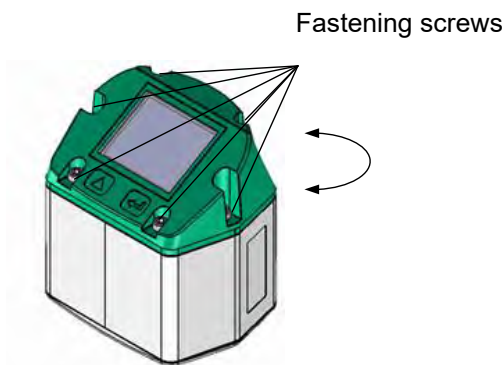

The Position of the Display head is twistable by 180 e.g. in case of reverse flow direction.  
For this purpose the 6 fastening screws are to be released and the display head rotated 180°.

**Caution:**

It must be ensured that the connection plugs are still plugged and the gasket is installed correctly.

## 6 Commissioning

The consumption sensor IVD 500 measures the flow velocity (differential pressure principle) in the center of the pipe.

### 6.1 Zero Point Adjustment



In order to achieve the required measurement accuracy, a zero point adjustment of the sensor must first be carried out at the start of the measurement.

- To do this, pull the sensor out completely to the stop.
- Then start the zero point calibration on the sensor.

Main menu → Sensor settings → Zero point, see also [chapter 10.3.1.5](#)

Carrying out the zero point adjustment again is recommended every 180 days!

### 6.2 4... 20 mA Analogausgang

#### ➤ IVD 500 with Display with 4... 20 mA analogue- and pulse output

**Please enter inner diameter of the pipe!**

**Values indicated in the display:**

Actual value in m<sup>3</sup>/h, m<sup>3</sup>/min etc.

Counter in m<sup>3</sup>, l, cf

as well as pulse output, 1 pulse per m<sup>3</sup>, l, cf

are calculated according to the set diameter. Please take the analogue value for flow rate 4... 20 mA from the tables on pages 13 - 14

4 mA always corresponds with the starting value 0 m<sup>3</sup>/h, 0 m<sup>3</sup>/min. The final value 20 mA can be taken from the tables on pages 13 -17.

Example IVD 500 High Speed version:

1" with inner diameter 25,0 mm:	4mA = 0 m <sup>3</sup> /h	20 mA = 295 m <sup>3</sup> /h
2" with inner diameter 53,1 mm:	4mA = 0 m <sup>3</sup> /h	20 mA = 1450 m <sup>3</sup> /h

#### ➤ IVD 500 without Display with 4... 20 mA analogue- and pulse output

**No adjustments are necessary at the consumption sensor.**

The respective final values for the flow rate can be taken from the tables on the pages xx - xx. Analogue start value 4 mA is always set as scaling value 0 m<sup>3</sup>/h, 0 m<sup>3</sup>/min etc. Analogue end value 20 mA is the final value, see tables pages 13 – 17..

Example IVD 500 High Speed -Version:

1" with inner diameter 25,0 mm:	4mA = 0 m <sup>3</sup> /h	20 mA = 295 m <sup>3</sup> /h
2" with inner diameter 53,1 mm:	4mA = 0 m <sup>3</sup> /h	20 mA = 1450 m <sup>3</sup> /h

## 7 Measuring ranges

The consumption sensor IVD 500 is available in 2 different versions:

- High Speed–Version                      max. measuring range of 224.0 m/s
- Ultra Speed –Version                      max. measuring range of 600.0 m/s

The sensors are **programmed to pipe inner diameter of 53,1 mm.**

	Measuring range	Analogoue output Scaling
• High Speed –Version	0 ...1450 m <sup>3</sup> /h	4mA =0 m <sup>3</sup> /h, 20mA = 1450 m <sup>3</sup> /h
• Ultra Speed –Version	0 ...2114 m <sup>3</sup> /h	4mA =0 m <sup>3</sup> /h, 20mA = 2114 m <sup>3</sup> /h

In case of use in **other** inner pipe diameter the diameter, using the display version, the diameter has to be set first.

The corresponding scale values for the respective version could be found in sections 5.1 to 5.3.

### Example:

Pipe 1", Inner diameter 25mm

	Measuring range	Analogoue output Scaling
• High Speed –Version	0 ...295 m <sup>3</sup> /h	4mA =0 m <sup>3</sup> /h, 20mA = 295 m <sup>3</sup> /h
• Ultra Speed–Version	0 ...430 m <sup>3</sup> /h	4mA =0 m <sup>3</sup> /h, 20mA = 430 m <sup>3</sup> /h

For changing the inner pipe diameter and adjusting the 4...20mA scaling, please refer to chapter "Operation".

### Please note:

The area outside the pipe (environment of the sensor) is **not allowed** to be an explosive area. (Ex area) .



The end values refer to application-typical conditions of 7 bara + 50°C.

The end values of the consumption sensor IVD 500 depend on temperature and pressure and change with changing operating conditions..

## 7.1 Maximum Flow ranges „High speed“

Inner diameter of the pipe		Flow (final value of measuring range in Nm <sup>3</sup> /h)		Max
Inchl	mm	Air <sup>2)</sup>	Air <sup>3)</sup>	m/s
3/4"	21,7	215	198	224,0
1"	25,0	295	272	224,0
	26,0	321	296	224,0
	27,3	357	328	224,0
	28,5	391	360	224,0
	30,0	437	402	224,0
1 1/4"	32,8	529	487	224,0
	36,0	644	592	224,0
	36,3	655	603	224,0
1 1/2"	39,3	775	713	224,0
	40,0	804	740	224,0
	41,9	886	816	224,0
	43,1	941	866	224,0
	45,8	1068	983	224,0
2"	50,0	1283	1180	224,0
	51,2	1346	1239	224,0
	53,1	1450	1335	224,0
	54,5	1529	1408	224,0
	57,5	1713	1577	224,0
	60,0	1870	1721	224,0
	64,2	2148	1977	224,0
2 1/2"	65,0	2205	2029	224,0
	70,3	2589	2383	224,0
	71,1	2648	2437	224,0
	76,1	3041	2799	224,0

Inner diameter of the pipe		Flow (final value of measuring range in Nm <sup>3</sup> /h)		Max.
Inch	mm	Air <sup>2)</sup>	Air <sup>3)</sup>	m/s
3"	80,0	3364	3097	224,0
	82,5	3582	3297	224,0
	84,9	3794	3492	224,0
	90,0	4268	3929	224,0
4"	100,0	5276	4856	224,0
	107,1	6059	5577	224,0
	110,0	6391	5883	224,0
5"	125,0	8263	7606	224,0
	133,7	9453	8701	224,0
6"	150,0	11913	10965	224,0
	159,3	13436	12367	224,0
	182,5	17656	16251	224,0
	190,0	19137	17614	224,0
8"	200,0	21230	19540	224,0
	206,5	22632	20831	224,0
10"	250,0	33211	30568	224,0
	260,4	36075	33204	224,0
12"	300,0	47881	44070	224,0
	309,7	51027	46966	224,0
	339,6	61356	56473	224,0
	400,0	85122	78347	224,0
	500,0	133003	122417	224,0
	600,0	191524	176281	224,0
	700,0	260685	239938	224,0
	800,0	340487	313388	224,0
	900,0	430929	396632	224,0
	1000,0	532011	489669	224,0

<sup>2)</sup> Referred to DIN 1945 / ISO 1217 (20°C, 1000mbar) and compressed air.

<sup>3)</sup> Referred to DIN 1343: 0°C, 1013,25 mbar

7.2 Maximum Flow ranges „Ultra speed“

Inner diameter of the pipe		Flow (final value of measuring range in Nm <sup>3</sup> /h)		Max
Inchl	mm	Air <sup>2)</sup>	Air <sup>3)</sup>	m/s
3/4"	21,7	578	531	600,0
1"	25,0	791	727	600,0
	26,0	860	791	600,0
	27,3	956	879	600,0
	28,5	1048	964	600,0
	30,0	1171	1077	600,0
1 1/4"	32,8	1416	1302	600,0
	36,0	1724	1585	600,0
	36,3	1755	1614	600,0
1 1/2"	39,3	2075	1908	600,0
	40,0	2152	1979	600,0
	41,9	2374	2183	600,0
	43,1	2521	2318	600,0
2"	45,8	2861	2631	600,0
	50,0	3435	3158	600,0
	51,2	3607	3316	600,0
	53,1	3884	3571	600,0
	54,5	4097	3767	600,0
2 1/2"	57,5	4588	4218	600,0
	60,0	5008	4605	600,0
	64,2	5755	5291	600,0
	65,0	5906	5430	600,0
	70,3	6934	6376	600,0
	71,1	7092	6521	600,0
	76,1	8145	7489	600,0

Inner diameter of the pipe		Flow (final value of measuring range in Nm <sup>3</sup> /h)		Max
Inchl	mm	Air <sup>2)</sup>	Air <sup>3)</sup>	m/s
3"	80,0	9012	8286	600,0
	82,5	9595	8822	600,0
	84,9	10162	9344	600,0
	90,0	11433	10512	600,0
	100,0	14132	12994	600,0
4"	107,1	16229	14922	600,0
	110,0	17120	15741	600,0
	125,0	22134	20351	600,0
5"	133,7	25321	23282	600,0
	150,0	31910	29340	600,0
	159,3	35990	33091	600,0
6"	182,5	47293	43484	600,0
	190,0	51260	47131	600,0
	200,0	56865	52285	600,0
	206,5	60621	55738	600,0
10"	250,0	88958	81793	600,0
	260,4	96628	88845	600,0
12"	300,0	128252	117922	600,0
	309,7	136680	125690	600,0
	339,6	164345	115130	600,0
	400,0	228004	209670	600,0
	500,0	356256	327610	600,0
	600,0	513009	471758	600,0
	700,0	698262	642116	600,0
	800,0	912017	838682	600,0
	900,0	1154271	1061458	600,0
	1000,0	1425026	1310441	600,0

<sup>2)</sup> Referred to DIN 1945 / ISO 1217 (20°C, 1000mbar) and compressed air.

<sup>3)</sup> Referred to DIN 1343: 0°C, 1013,25 mbar

## 8 Dimension

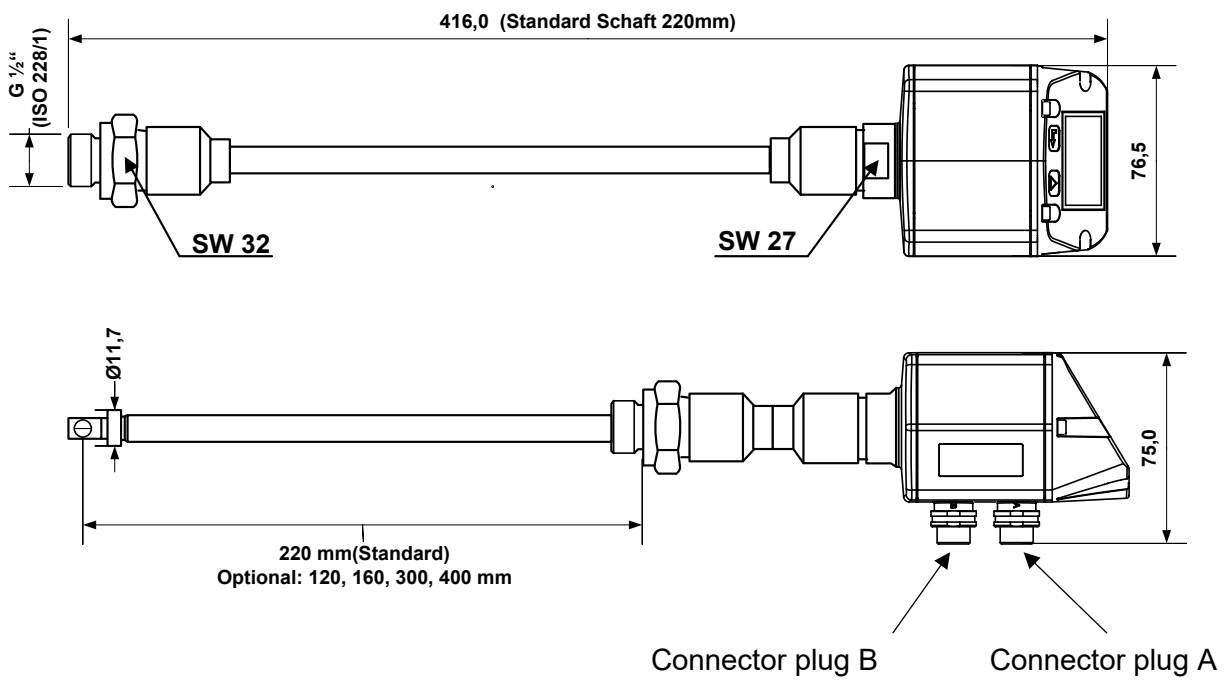

## 9 Electrical wiring

### 9.1 Modbus RTU, 4..20mA, Pulse or MBus

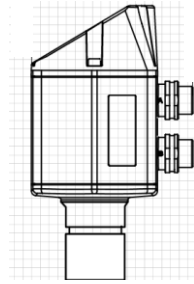

Connector plug A

Connector plug B

**Attention:** Not required connections NC must not be connected to a voltage and/or to protection earth. Cut and insulate cables.

	Pin 1	Pin 2	Pin 3	Pin 4	Pin 5
<b>Connector plug A</b>	+VB	RS 485 (A)	-VB	RS 485 (B)	I+ 4..20 mA
<b>Connector plug B</b> Pulse output (standard)	NC	GND	DIR	Pulse galv. isolated	Pulse galv. isolated
<b>Connector plug B</b> Option MBus	NC	GND	DIR	MBus	MBus
Colours pulse cables 0553 0106 (5 m) 0553.0107 (10 m)	brown	white	blue	black	grey

**Legend:**

-VB	Negative supply voltage 0 V
+VB	Positive supply voltage 18...36 VDC smoothed
I +	Current signal 4...20 mA – selected measured signal
RS 485 (A) RS 485 (B)	Modbus RTU A Modbus RTU A

Pulse	Pulse for consumption
NC	Must not be connected to a voltage and/or to protection earth. Please cut and isolate cables.
MBus	MBus (reverse polarity protected)

If no connection cable/ pulse cable is ordered the sensor will be supplied with a M12 connector plug. The user can connect the supply and signal cables as indicated in the connection diagram.

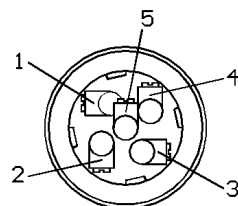

**M12 Connector plug**

View from back side (terminal side)

#### Connector plug A (M12 - A-coding)

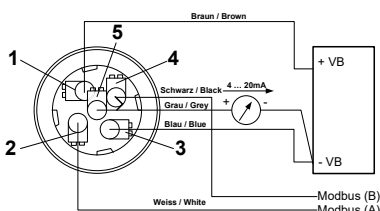

#### Connector plug B (M12 - A-coding)

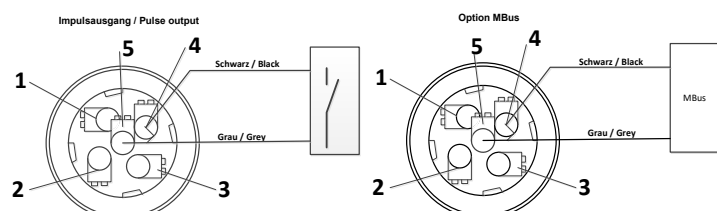

**Remark:** If the sensor is placed at the end of the Modbus system a termination is required. The sensors have an internal switchable termination, therefore the 6 fastening screws from the lid are to be released and set the internal DIP Switch to "On". It must be ensured that the connection plugs are still plugged and the gasket is installed correctly.

Alternatively, a 120R resistor can be installed in the plug between pin 2 and pin 4.



## 9.2 Ethernet (optional PoE)

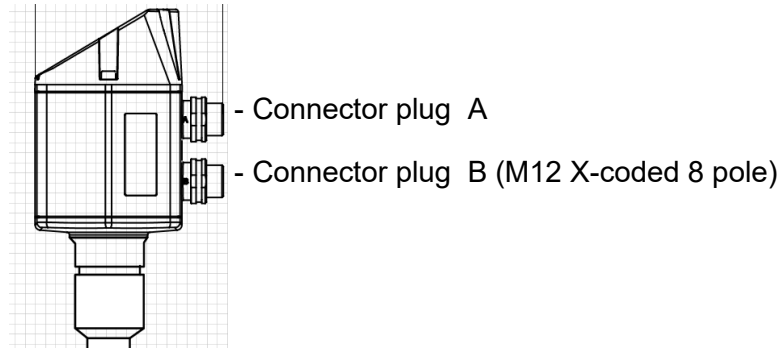

### Connector plug B

M12 x-coded 8 pole

Data LINES: 1,2 und 3,4

PoE LINES: 5,6 und 7,8

### Connection cable

M12 x-coded to RJ45

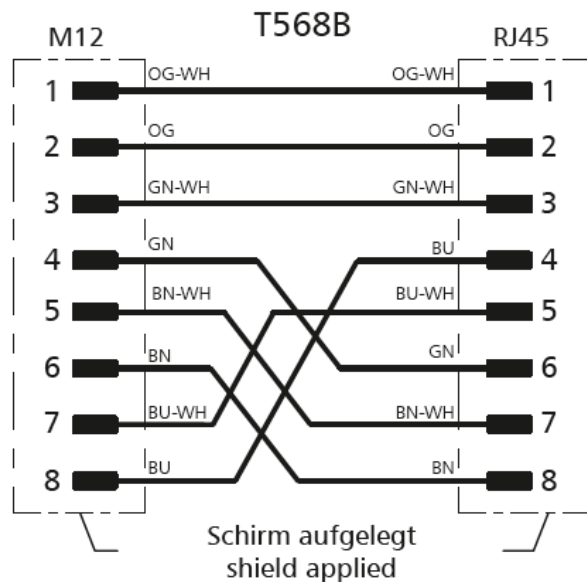
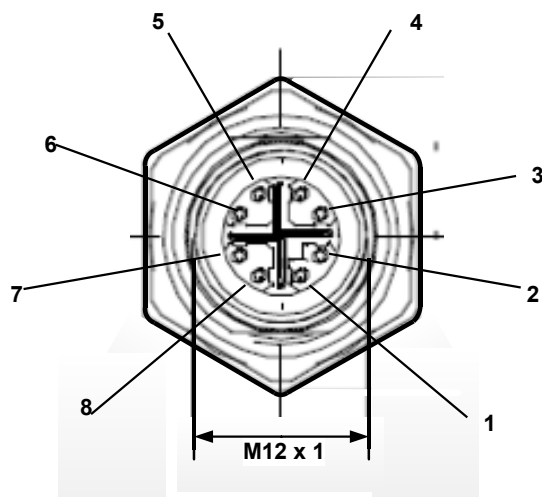

**Connection cable:** Cat 6.

\*PoE: Power over Ethernet

## 10 Operation

**Remark:** In version with display only.

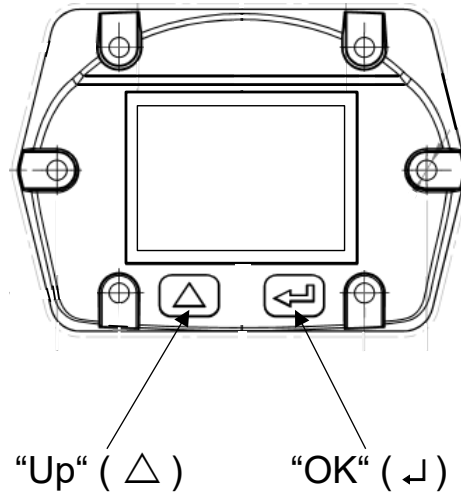

The operation of the IVD 500 is done by the two capacitive key buttons Up (Δ) und Enter (↵)

## 10.1 Initialization

After switching on the IVD 500, the initialized screen is displayed followed by the main menu.

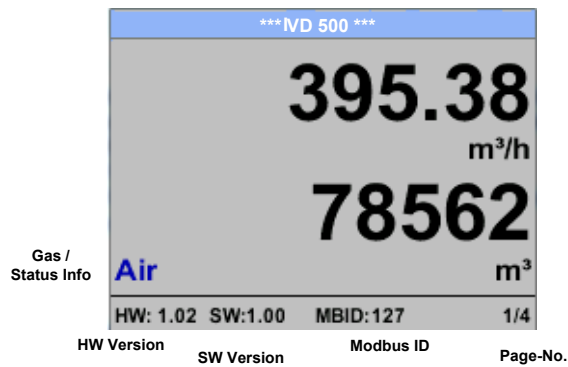

Switching to pages 2-4 or back by pressing key „△“

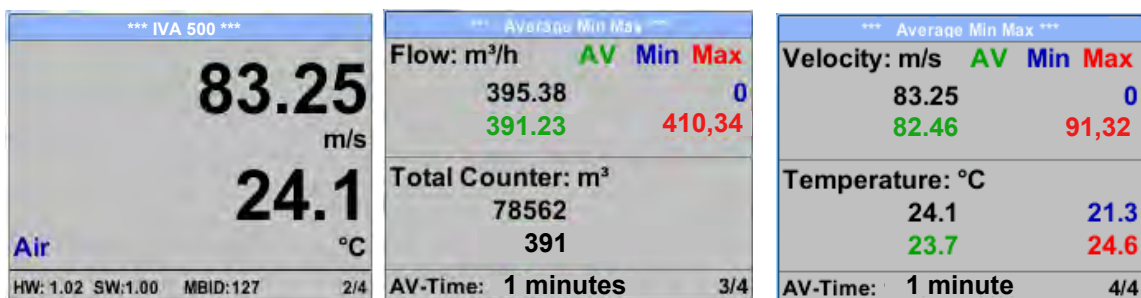

AV-Time ( Period for average value calculation) could be changed under *Sensor Setup.-Advanced- AV-Time*

### 10.3 Settings

The settings menu could accessed by pressing the key „OK“.

But the access to the *settings menu* is password protected.



Factory settings for password at the time of delivery: 0000 (4 times zero).

If required the password could be changed at *Setup–User setup-Password*.

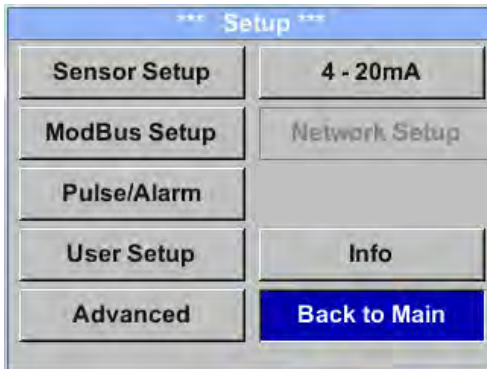

Selection of a menu item or to change a value is done with the key „ $\Delta$ “, a final move to the chosen menu item or takeover of the value change needs the confirmation by pressing the key „OK“

### 10.3.1 Sensor Setup

Setup → Sensor Setup

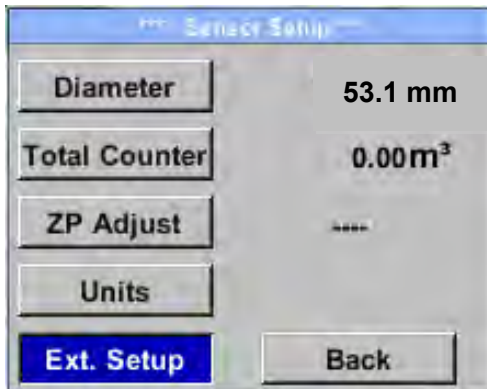

For changes, first select the menu item with key „ $\Delta$ “ and then confirm it with **“OK”**.

#### 10.3.1.1 Input / change tube diameter

Settings → Sensor Setup → Diameter

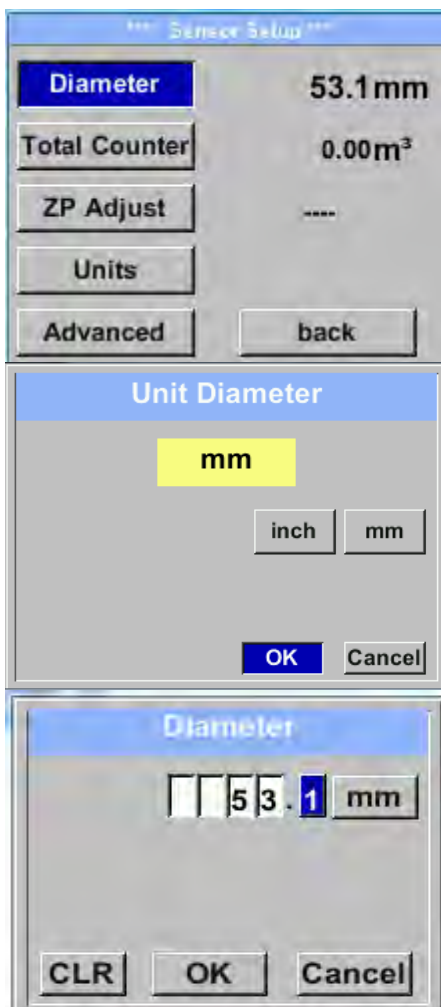

In order to change, e.g. the unit, first select by pressing key „ $\Delta$ “ the field **“Units”** and then key **“OK”**.

Select with the key „ $\Delta$ “ the correct unit and then confirm selection by pressing 2x **„OK”**.

Entering / changing the diameter via button „ $\Delta$ “, select the respective position and activate the position with the **“OK”** button.

By pressing „ $\Delta$ “ the position value is incremented by 1. Complete with **“OK”** and activate next number position. Confirm entry by pressing **„OK”**.

10.3.1.2 Input / change consumption counter

Setup → Sensor Setup → Total Counter → Unit button

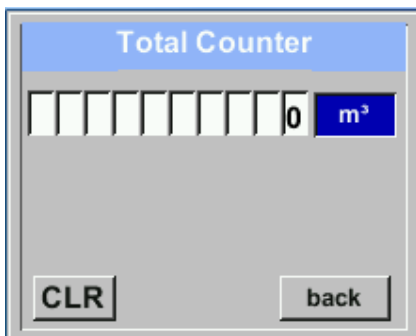
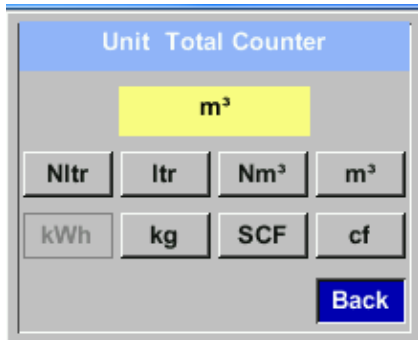

In order to change, e.g. the unit, first select by pressing key „ $\Delta$ “ the button **“Unit”** and then key **“OK”**.

Select with the key „ $\Delta$ “ the correct unit and then confirm selection by pressing 2x **„OK“**.

Entering / changing the consumption counter via button „ $\Delta$ “, select the respective position and activate the position with the **“OK”** button.

By pressing „ $\Delta$ “ the position value is incremented by 1. Complete with **“OK”** and activate next number position.

Confirm entry by pressing **„OK“**.

**Important!**

When the counter reach 100000000 m<sup>3</sup> the counter will be reset to zero.

10.3.1.3 Definition of the units for flow, velocity, temperature and pressure

Setup → Sensor Setup → Units

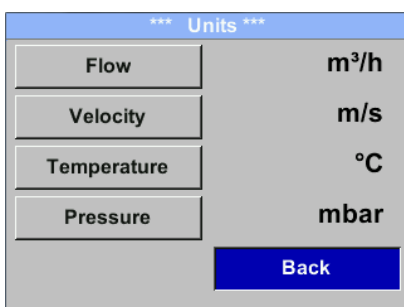

To make changes to the unit for the respective measurement value, first select by pressing „ $\Delta$ “ the field of the „measurement value“ and activate „it with **„OK“** .

Selection of the new unit with **„ $\Delta$ “**

In case the quantity of units selectable are not presentable on one page, pleas move to next page by pressing **„<<“** .

Confirm selection by pressing 2x **„OK“**.

Procedure for all 4 measurement variables is analogous.

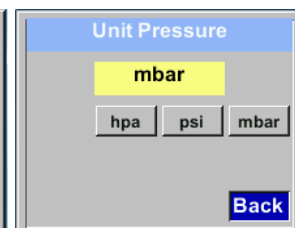
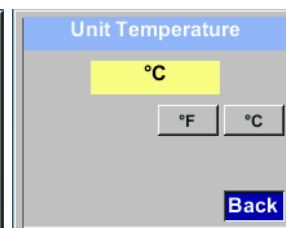
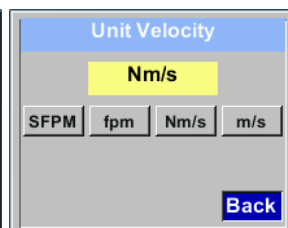
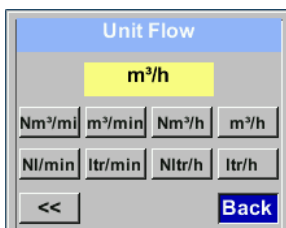

**10.3.1.4 Definition of the reference conditions**

Here can be defined the desired measured media reference conditions for pressure and temperature and times for the filter and averaging.

- Factory presetting for reference temperature and reference pressure are 20 °C, 1000 hPa
- All volume flow values (m³/h) and consumption values indicated in the display are related to 20 °C and 1000 hPa (according to ISO 1217 intake condition)
- Alternatively 0 °C and 1013 hPa (=standard cubic meter) can also be entered as a reference.
- **Do not enter the operation pressure or the operation temperature under reference conditions!**

Setup → Sensor Setup → Advanced

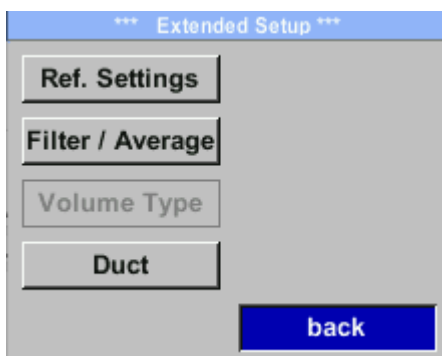

To make changes, first select a menu with button „Δ“ and confirm selection by pressing „OK“ .

Setup → Sensor Setup → Advanced → Ref.Settings → Ref.Pref

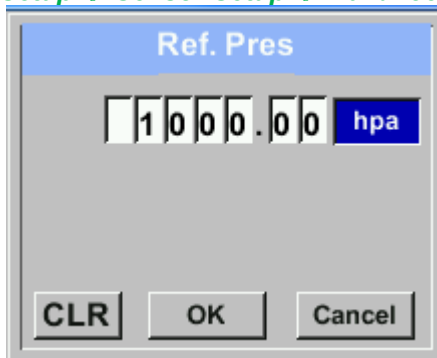

In order to change, e.g. the unit, first select by pressing key „Δ“ the field “Units” and then key “OK”.

Select with the key „Δ“ the correct unit and then confirm selection by pressing 2x „OK”.

Input / change of the value by selecting the respective position with button „Δ“ and entering by pressing button „OK” .

Setup → Sensor Setup → Advanced → Ref.Settings → Ref.Temp

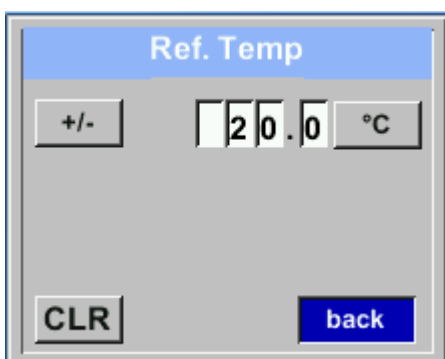

By pressing „Δ“ the position value is incremented by 1. Complete with “OK” and activate next number position.

Procedure for changing the reference temperature is the same.

Setup → Sensor Setup → Advanced → Filter/Average → Filtertime

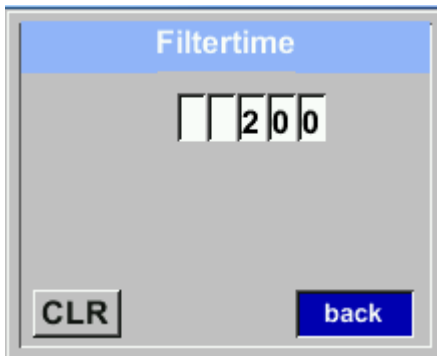

Under item **"Filtertime"** an attenuation can be defined.  
Input values of 0 -10000 in [ms] are possible

Setup → Sensor Setup → Advanced → Filter/Average → AV-Time

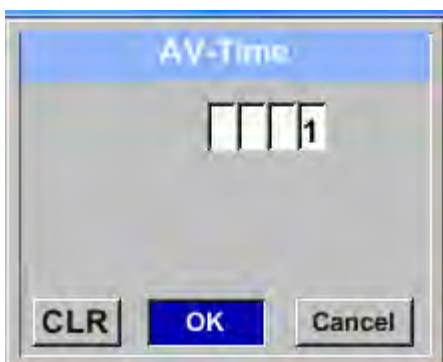

The time period for averaging can be entered here.  
Input values of 1-1440 [minutes] are possible.  
For average values see display window 3 + 4

Setup → Sensor Setup → Advanced → Filter/Average → Filtertype

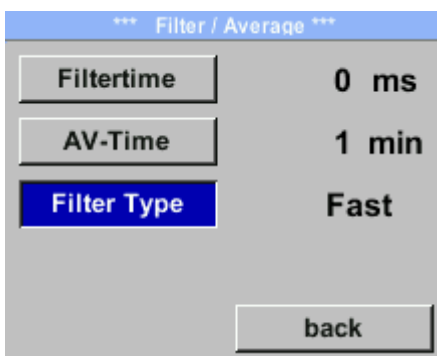

Please note that for some special measurement applications it is necessary to adjust the parameter **"Filter Type"**.

There are 3 different filter types **"Normal"**, **"Fast"** and **"Slow"** implemented. Adjustment by selecting the **"Filter Type"** button and changing with **"OK"**.

- Normal: for all general measurements.
- Fast: For measurements with very fast changes in measured values
- Slow: for measurements after the compressor (pulsating flow)



10.3.1.5 Setting of Zeropoint and Low-flow cut off

Setup → Sensor Setup → ZP Adjust

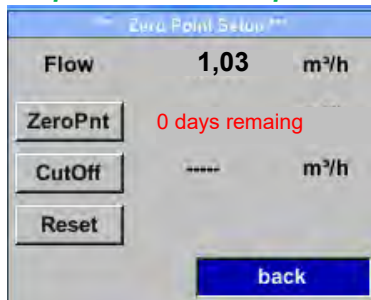

To make changes, first select a menu with button „ $\Delta$ “ and confirm selection by pressing „OK“ .

Setup → Sensor Setup → ZP Adjust → ZeroPnt

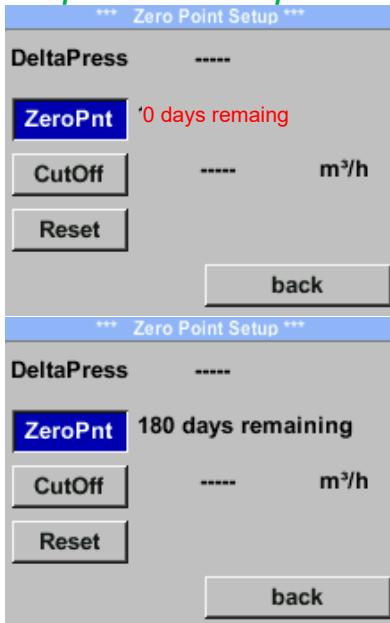

If the sensor shows the message **CalZeroPnt** in the display, then a zero point calibration should be carried out, see also chapter **Commissioning**.

 For zero point calibration, pull the sensor out completely to the stop.

Select the **ZeroPnt** key and complete with **OK**

Exit the menu with **Back**

Setup → Sensor Setup → ZP Adjust → CutOff

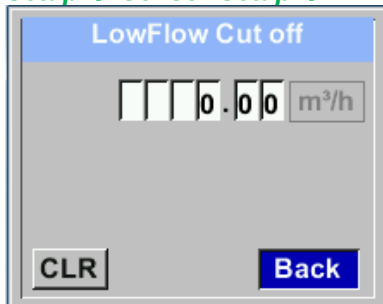

With the low-flow cut off activated, the flow below the defined "LowFlow Cut off" value will be displayed as 0 m³/h and not added to the consumption counter.

For an input / change of the value select with the button „ $\Delta$ “ the respective number position and activate it with „OK“.

By pressing „ $\Delta$ “ the position value is incremented by 1. Confirm the input with „OK“ and activate next number position.

Leave menu with button **Back**

Setup → Sensor Setup → ZP Adjust t → Reset



By selection of **Reset** all settings for **ZeroPnt** and **CutOff** are reset.

Menu item to be select with button „ $\Delta$ “ and confirm the reset with „OK“ .

Leave menu with button **Back**

### 10.3.2 Modbus Settings

#### 10.3.2.1 Modbus RTU Setup

The Flow sensors IVD 500 comes with a Modbus RTU Interface. Before commissioning the sensor the communication parameters

- Modbus ID, Baudrate, Parity und Stop bit

must be set in order to ensure the communication with the Modbus master.

#### Settings → Modbus Setup

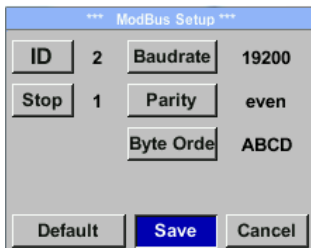
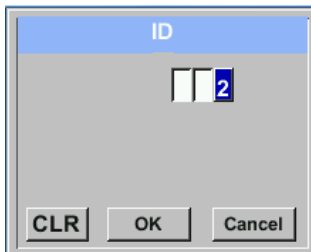
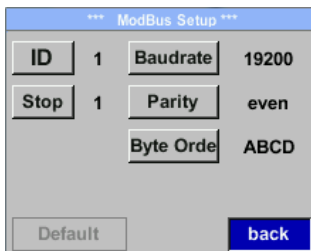

For changes, e.g. the sensor ID, first select by pressing key „△“ the field **“ID”** and then key **“OK”**.

Select the desired position by pressing the **“>”** and select with **“OK”** button.

Change values by pressing the **„△“** values takeover by pressing **“OK”**.

Inputs for baudrate, stopbit and parity is done analogue.

By means of the button "Byte Order" it is possible to change the data format (Word Order). Possible formats are "ABCD" (Little Endian) and "CDAB" (Middle Endian)

Saving the changes by pressing **“Save”**, therefore select it with key **„△“** and then confirm it with **“OK”**. To set back to default values please press button **“Set to Default”**

#### Default values out of factory: Modbus

ID: 1

Baud rate: 19200  
 Stopbit: 1  
 Parity: even  
 Byte Order: ABCD

**Remark:** If the sensor is placed at the end of the Modbus system a termination is required. The sensors have an internal switchable termination, therefore the 6 fastening screws from the lid are to be released and set the internal DIP Switch to “On”.

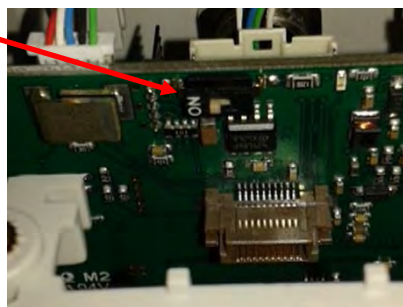
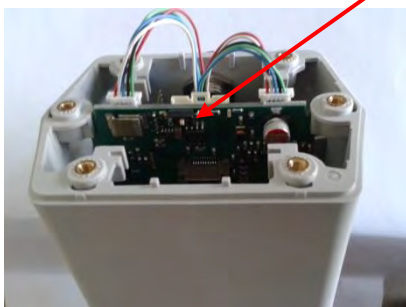

Alternatively, a 120R resistor can be installed in the plug between pin 2 and pin 4.

It must be ensured that the connection plugs are still plugged and the gasket is installed correctly, see also chapter 4.5.

### 10.3.2.2 Modbus TCP (Optional)

The Flow sensors IVD 500 comes optional with a Modbus TCP Interface (HW Interface:M12 x 1 X-coded connector).

Device supports with this option the Modbus TCP protocol for communication with SCADA systems. TCP port is set to 502 by default. Port can be changed at the sensor or using PC Service Software

Modbus device address (Unit Identifier) can be set in the range of 1- 255. Specification and description of the Modbus protocol is free to download on: [www.modbus.org](http://www.modbus.org).

Supported Modbus commands (functions):

Command	Code	Description
Function Code	3	(Read holding register)
Function code	16	(Write multiple registers)

For more details, please see **VA 5xx Modbus RTU\_TCP Installation V1.10**

#### Settings → Network Setup

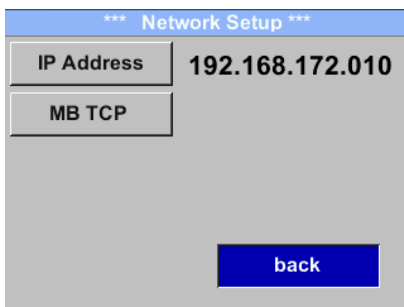

#### 10.3.2.2.1 Network Setup DHCP

#### Settings → Network Setup Settings → IP Address

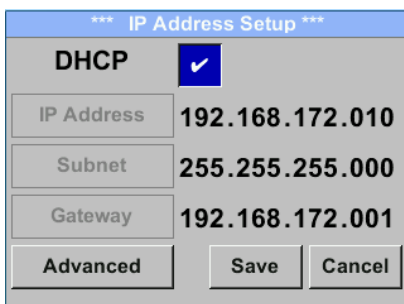

Here you can set up and made a connection, with or without *DHCP*, to a computer.

**Remark:**  
With activated *DHCP* the automatic integration of the sensor in an existing network is possible, without a manual configuration.

Storing of settings by pressing **“Save”**

10.3.2.2.2 Network Settings static IP

Settings → Network Setup Settings → IP Address → IP Address

Settings → Network Setup Settings → IP Address → Sub Netz

Settings → Network Setup Settings → IP Address → Gateway

\*\*\* IP Address Setup \*\*\*

DHCP

IP Address 192.168.172.010

Subnet 255.255.255.000

Gateway 192.168.172.001

Advanced back

\*\*\* IP Address Setup \*\*\*

DHCP

IP Address 192.168.172.010

Subnet 255.255.255.000

Gateway 192.168.172.001

Advanced back

IP Setup

1 9 2

CLR back

For manual (static) IP, the "IP Address", "Subnet" and "Gateway" selection keys must be selected and activated with "OK".

The first data field of the selection, in this case the IP address, is then marked (red).

Confirm with "OK" the corresponding input menu is opened.

By means of ">", the next data field is changed.

Select the desired position with the ">" key and activate it with the "OK" key.

Change the values with the ">" key, and accept the values with the "OK" key.

Procedure for "Subnet" and "Gateway" is analogous.

Subnet Setup

2 5 5

CLR back

Gateway Setup

1 9 2

CLR back

\*\*\* IP Address Setup \*\*\*

DHCP

IP Address 192.168.172.011

Subnet 255.255.255.000

Gateway 192.168.172.001

Advanced Save Cancel

Store the settings by „Save“

10.3.2.2.3 Modbus TCP Settings

Settings → Network Setup Settings → IP Address → MB TCP

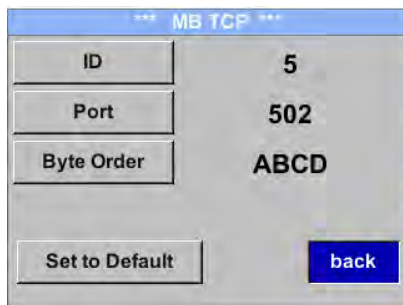

Settings → Network Setup Settings → IP Address → ID

Settings → Network Setup Settings → IP Address → Port

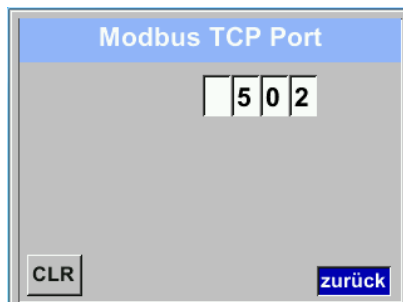
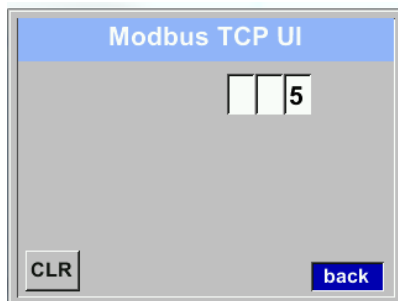

For changes, e.g. the sensor ID, first select by pressing key „>“ the field “ID” and then key “OK”.

Select the desired position by pressing the “>” and select with “OK” button.

Change values by pressing the „>“ values takeover by pressing “OK”.

Input for the port is done analogue.

By means of the button “Byte Format” it is possible to change the data format (Word Order). Possible formats are “ABCD” (Little Endian) and “CDAB” (Middle Endian)

Saving the changes by pressing “Save”, therefore select it with key „>“ and then confirm it with “OK”.

Reset to the default settings by activating “Set to Default”-

10.3.2.3 Modbus Settings Register (2001...2005)

Modbus Register	Register Address	No. of Byte	Data Type	Description	Default Setting	Read Write	Unit /Comment
2001	2000	2	UInt16	Modbus ID	1	R/W	Modbus ID 1...247
2002	2001	2	UInt16	Baudrate	4	R/W	0 = 1200 1 = 2400 2 = 4800 3 = 9600 4 = 19200 5 = 38400
2003	2002	2	UInt16	Parity	1	R/W	0 = none 1 = even 2 = odd
2004	2003	2	UInt16	Number of Stopbits		R/W	0 = 1 Stop Bit 1 = 2 Stop Bit
2005	2004	2	UInt16	Word Order	0xABCD	R/W	0xABCD = Big Endian 0xCDAB = Middle Endian
2069	2068	4	Float	Pressure Type (Abs/Rel)		R/W	0 = Relative 1 = Absolute

10.3.2.4 Values Register (1001 ...1500)

Modbus Register	Register Address	No. of Byte	Data Type	Description	Default	Read Write	Unit /Comment
1101	1100	4	Float	Flow in m³/h		R	
1109	1108	4	Float	Flow in Nm³/h		R	
1117	1116	4	Float	Flow in m³/min		R	
1125	1124	4	Float	Flow in Nm³/min		R	
1133	1132	4	Float	Flow in ltr/h		R	
1141	1140	4	Float	Flow in Nltr/h		R	
1149	1148	4	Float	Flow in ltr/min		R	
1157	1156	4	Float	Flow in Nltr/min		R	
1165	1164	4	Float	Flow in ltr/s		R	
1173	1172	4	Float	Flow in Nltr/s		R	
1181	1180	4	Float	Flow in cfm		R	
1189	1188	4	Float	Flow in Ncfm		R	
1197	1196	4	Float	Flow in kg/h		R	
1205	1204	4	Float	Flow in kg/min		R	
1213	1212	4	Float	Flow in kg/s		R	
1221	1220	4	Float	Flow in kW		R	

Modbus Register	Register Address	No. of Byte	Data Type	Description	Default	Read Write	Unit / Comment
1269	1268	4	UInt32	Consumption m <sup>3</sup> before comma	x	R	
1275	1274	4	UInt32	Consumption Nm <sup>3</sup> before comma	x	R	
1281	1280	4	UInt32	Consumption ltr before comma	x	R	
1287	1286	4	UInt32	Consumption Nltr before comma	x	R	
1293	1292	4	UInt32	Consumption cf before comma	x	R	
1299	1298	4	UInt32	Consumption Ncf before comma	x	R	
1305	1304	4	UInt32	Consumption kg before comma	x	R	
1311	1310	4	UInt32	Consumption kWh before comma	x	R	
1347	1346	4	Float	Velocity m/s			
1355	1354	4	Float	Velocity Nm/s			
1363	1362	4	Float	Velocity Ft/min			
1371	1370	4	Float	Velocity NFt/min			
1419	1418	4	Float	GasTemp °C			
1427	1426	4	Float	GasTemp °F			
1475	1474	4	Float	Systempressure mBar		R	Value depending on register "Pressure type" setting
1481	1480	4	Float	Systempressure Bar		R	
1487	1486	4	Float	Systempressure PSIr		R	
1057	1056	4	Float	Delta P		R	Unit as in sensor / display defined

**Remark:**

- **For DS400 / DS 500 / Handheld devices - Modbus Sensor Datatype**  
„Data Type R4-32“ match with „Data Type Float“
- For more additional Modbus values please refer to  
VA5xx\_Modbus\_RTU\_Slave\_Installation\_1.10\_EN.doc

### 10.3.3 Pulse /Alarm

Setup → Sensor Setup → Pulse/ Alarm

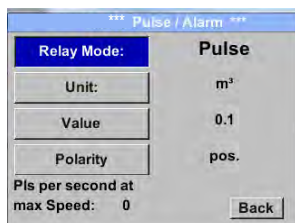
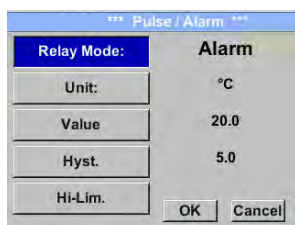
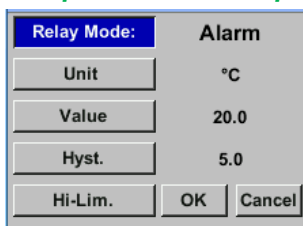

The galvanically isolated output can be defined as pulse- or alarm output. Selection of field „**Relay Mode**” with key „**Δ**” and change modus by pressing key „**OK**”.

For alarm output following units could be chosen: kg/min, cfm, ltr/s, m³/h, m/s, °F, °C and kg/s.

„**Value**” defines the Alarm value, „**Hyst.**” defines the desired hysteresis and with „**Hi-Lim**” or „**Lo-Lim**” the alarm settings when the alarm is activated

Hi-Lim: Value over limit

Lo-Lim: Value under limit

For the pulse output following units could be chosen: kg, cf, ltr and m³. The pulse value definition to be done in menu „**Value**” . Lowest value is depending on max. flow of sensor and the max frequency of pulse output of 50Hz.

With „**Polarity**” the switching state could be defined. Pos. = 0 → 1 neg. 1 → 0

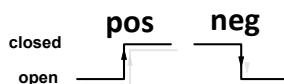

#### 10.3.3.1 Pulse output

The maximum frequency for pulse output is 50 pulses per second (50Hz).

The Pulse output is delayed by 1 second.

Pulse value	[m³ /h]	[m³ /min]	[l/min]
0.1 ltr / Pulse	18	0,3	300
1ltr / Pulse	180	3	3000
0.1m³ / Pulse	18000	300	300000
1 m³ / Pulse	180000	3000	3000000

Table 1 Maximum flow for pulse output

Entering pulse values that are not allow a presentation to the full scale value, are not allowed. Entries are discarded and error message displayed.



### 10.3.4 User Setup

#### 10.3.4.1 Password

Settings → UserSetup → Password

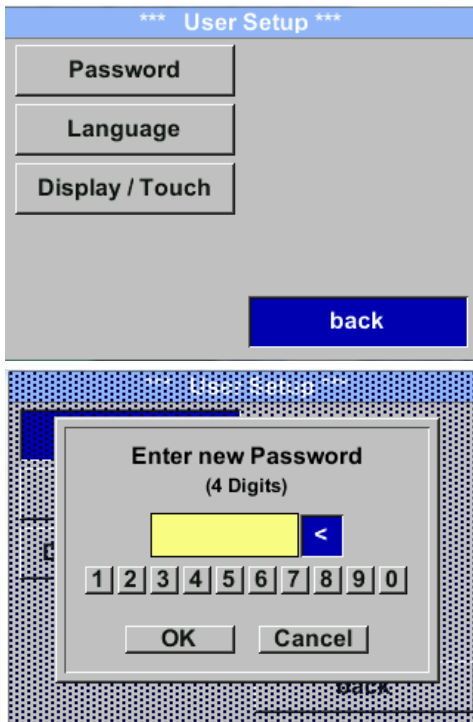

To make changes, first select a menu with button „ $\Delta$ “ and confirm selection by pressing „OK“.

It is possible to define a password. The required password length is 4 digits. Please select with button „ $\Delta$ “ a figure and confirm it with „OK“. Repeat this 4 times.

With „ $\Delta$ “ the last figure could be deleted. Password input have to be inserted twice.

Confirmation of input/password by pressing „OK“.

**Factory settings for password at the time of delivery: 0000 (4 times zero).**

#### 10.3.4.2 Language

Settings → UserSetup → Language

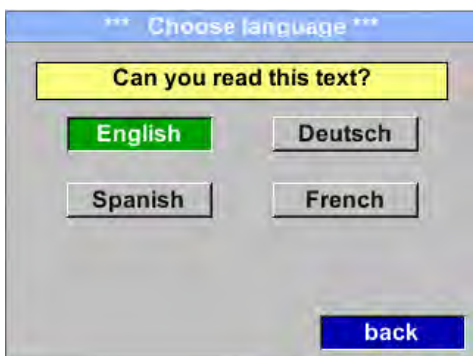

Currently 4 languages have been implemented and could be selected with button „ $\Delta$ “.

Change of language by confirming with “OK”. Leaving the menu with button “back”.

### 10.3.4.3 Display / Touch

Settings → UserSetup → Display / Touch

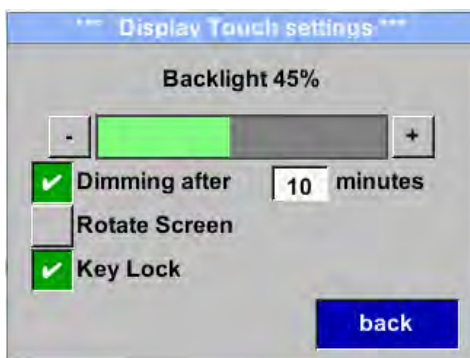
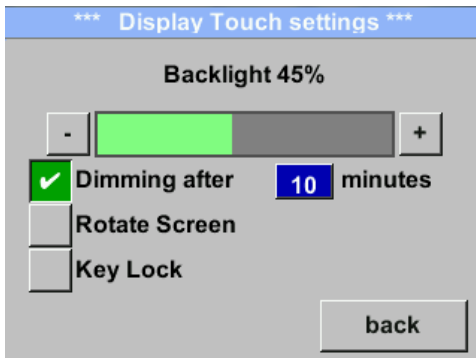

With the button „-“ and with button „+“ it is possible to adjust the backlight / display brightness. The actual / adjusted backlight brightness is shown in the graph „**Backlight.**“

By activation **“Dimming after”** and entering a time a display dimming could be set.

With **„Rotate Screen“** the display information could be rotated by 180°.

By activation of **„Key Lock“** the operation of the sensor locked.

Unlocking the keyboard is only possible by restarting the sensor and calling the operating menu within the first 10s. To do this, use the **“OK”** button to enter the operating menu during this period

### 10.3.5 Advanced

Settings → Advanced



By pressing **„Factory Reset“** the sensor is set back to the factory settings.

10.3.6 4 -20mA

Settings → 4-20mA

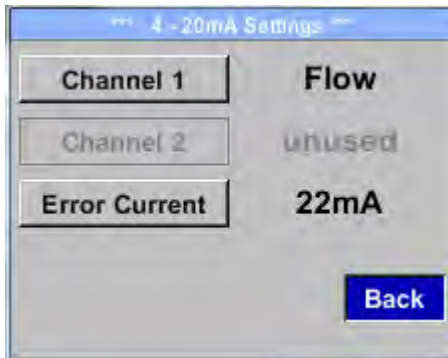

To make changes, first select a menu with button „ $\Delta$ “ and confirm selection by pressing „OK“ .

Settings → 4-20mA → Channel 1

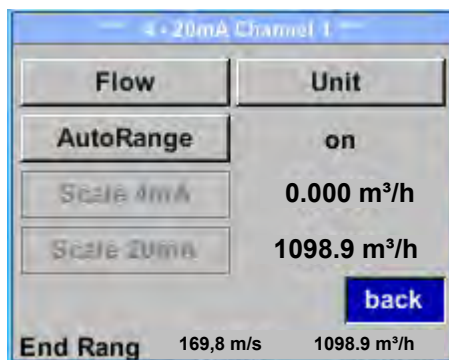

The 4-20 mA Analogue output of the Sensor IVD 500 can be individually adjusted.

It is possible to assign following values „Temperature“, „Velocity“ und „Flow“ to the channel CH 1.

To make changes, first select the value item with button „ $\Delta$ “ .and confirm  
Moving between the different measurements values or to deactivate the 4-20mA with setting to „unused“ by pressing „OK“.

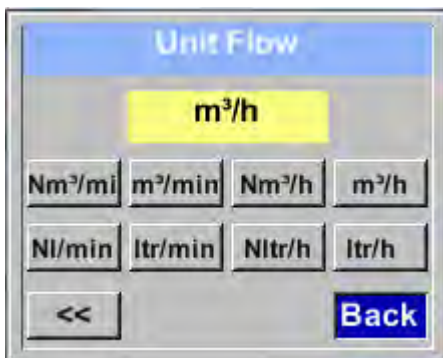

To the selected measurement value a corresponding / appropriate unit needs to be defined. Select „Unit“ with „ $\Delta$ “ and open menu with „OK“.  
Select required unit with „ $\Delta$ “ and take over by pressing „OK“.

Here e.g. for the measurement value Flow, procedure for the other measurements values is analog.

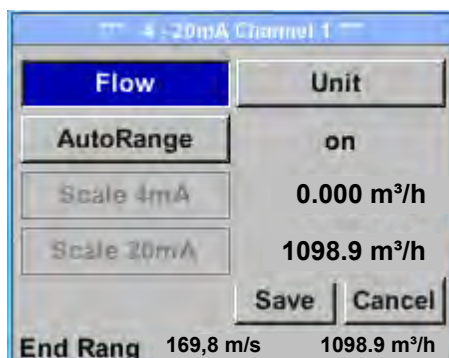

For saving the changes done press button „Save“ to discard the changes press button „Cancel“.

Leaving the menu with „Back“.

Settings → 4..20mA → Channel 1 Auto Scale

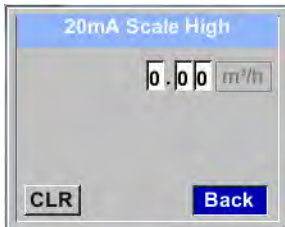
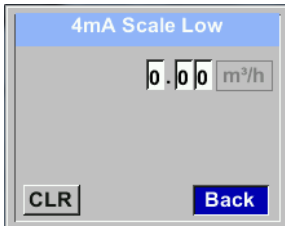
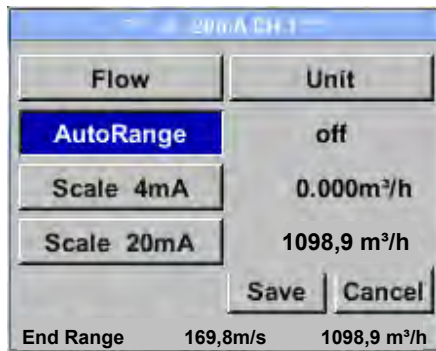

The scaling of the 4-20mA channel can be done automatically "Auto Range = on" or manual "AutoRange = off" .

With button „ $\Delta$ “ select the menu item „AutoRange“ select with „OK“ the desired scaling method. (Automatically or manually)

In case of **AutoRange = off** with „Scale 4mA“ und „Scale 20mA“ the scale ranges needs to be defined.

Select with button „ $\Delta$ “ the item „Scale 4mA“ or „Scale 20mA“ and confirm with „OK“ .

Input of the scaling values will be analogous as described before for value settings.

Using „CLR“ clears up the complete settings at once.

For „Auto on“ , the max. scaling is calculated based on the inner tube diameter, max. measurement range and the reference conditions settings.

Take over of the inputs with „Save“ and leaving the menu with „Back“.

Settings → 4-20mA → Error Current

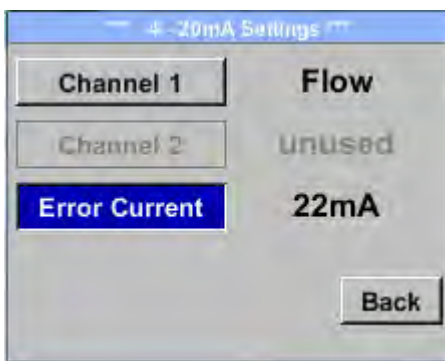

This determines what is output in case of an error at the analog output.

- 2 mA Sensor error / System error
- 22 mA Sensor error / System error
- None Output according Namur (3.8mA – 20.5 mA)  
 < 4mA to 3.8 mA Measuring range under range  
 >20mA to 20.5 mA Measuring range exceeding

To make changes first select a menu item "Current Error" with button „ $\Delta$ “ and then select by pressing the „OK“ the desired mode

For saving the changes done press button „Save“ to discard the changes press button „Cancel“.

Leaving the menu with „Back“.

### 10.3.7 IVD 500 Info

Setup → Sensor Setup → Info



Here you get a brief description of the sensor data incl. the calibration data.

Under **Details**, you are able to see in addition the calibration conditions.

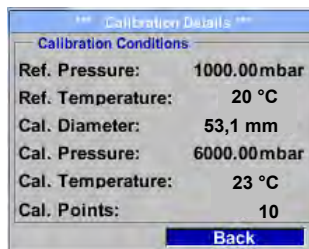

### 10.4 MBus

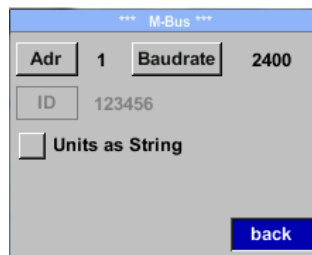

The Sensor offers two possibilities for coding the Value Information Field (VIF).

- Primary VIF (The units and multiplier correspond to MBus specification 4.8 chapter 8.4.3)
- Plain text VIF ((units are transmitted as ASCII characters. So units that are not included in MBus specification chapter 8.4.3 are possible)

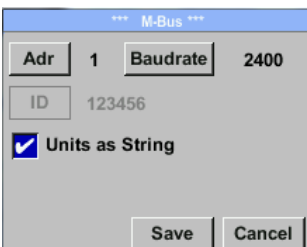

Switch to Plain Text VIF by activation of **„Units as String“**.

#### 10.4.1 Default Settings communication

Primary Address\*: 1  
 ID: Serialnumber of Sensor  
 Baud rate\*: 2400  
 Medium\*: depending on medium (Gas or Compressed Air)  
 Manufacturer ID: CSI  
 VIF coding: Primary VIF

Both addresses, Primary address and ID, could be automatic searched in the M-Bus system.

#### 10.4.2 Default values transmitted

Value 1 with [Unit]\*: Consumption [m³]  
 Value 2 with [Unit]\*: Flow [m³/h]  
 Value 3 with [Unit]\*: Gas temperature [°C]

# 11 Status / Error messages

## 11.1 Status messages

- **CAL**

On the part of ICS a regular re-calibration is recommended, see chapter 13.

At delivery, the date at which the next recalibration is recommended is internally entered.

When this date is reached, a message appears in the display with the status message „CAL“.

**Note:** The measurement will continue without interruption or restriction.

- **Direction**

When used in conjunction with a direction switch VA409, the status message "Direction" is displayed in case of opposite flow direction and no measurement may take place.

**Status messages:**

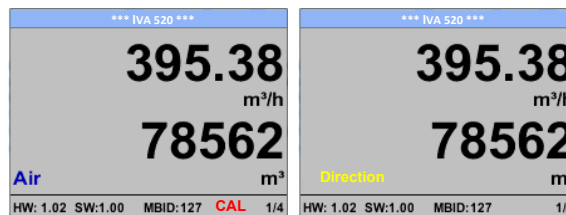

## 11.2 Error messages

- **Low Voltage**

If the supply voltage is less than 11V, the warning message „**Low Voltage**“ is displayed. This means that the sensor can no longer work / measure correctly and thus there are none measured values for flow, consumption and speed are available.

- **Internal Error**

In the case of this message „**Internal Error**“, the sensor has an internal read error on e.g. EEPROM, AD converter etc. detected.

- **Temp out of Range**

At media temperatures outside the specified temperature range, the status message „**Temp out of Range**“ occurs.

This temperature overshoot leads to incorrect measurement values (outside the sensor specification).

- **Low Voltage 4-20mA**

For sensors with a galvanically isolated 4-20mA output, a min. Supply voltage of 17.5V is required. If this value is undershot, the error message „**Low Voltage 4-20mA**“ is displayed.

### Error messages:

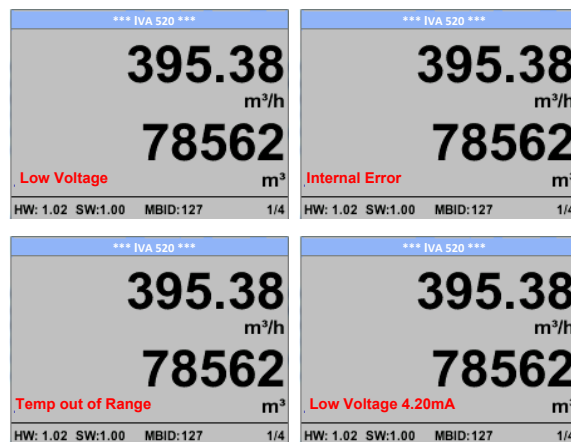

## **12 Maintenance**

The sensor head should be checked regularly for dirt and cleaned if necessary. Should dirt, dust or oil accumulate, a deviation will occur in the measuring value. An annual check is recommended. Should the compressed air be heavily soiled this interval must be shortened.

## **13 Re-Calibration**

If no customer specifications are given then we recommend carrying out calibration every 12 months. For this purpose, the sensor must be sent to the manufacturer.

## **14 Spare parts and repair**

For reasons of measuring accuracy spare parts are not available. If parts are faulty, they must be sent to the supplier for repair.

If the measuring device is used in important company installations, we recommend keeping a spare measuring system ready.

## **15 Calibration**

According to DIN ISO certification of the measuring instruments we recommend to calibrate and if applicable to adjust the instruments regularly from the manufacturer. The calibration intervals should comply with your internal specification. According to DIN ISO we recommend a calibration interval of one year for the instrument IVD 500.

On request and additional payment, calibration-certificates could be issued. The precision is given due to use DKD-certified flow meters and verifiable

## **16 Warranty**

If you have reason for complaint, we will of course repair any faults free of charge if it can be proven that they are manufacturing faults. The fault should be reported immediately after it has been found and within the warranty time guaranteed by us. Excluded from this warranty is damage caused by improper use and non-adherence to the instruction manual.

The warranty is also cancelled once the instrument has been opened - as far as this has not been mentioned in the instruction manual for maintenance purposes - or if the serial number in the instrument has been changed, damaged or removed.

The warranty time for the IVD 500 is 12 months. If no other definitions are given the accessory parts have a warranty time of 6 months. Warranty services do not extend the warranty time.

If in addition to the warranty service necessary repairs, adjustments or similar are carried out the warranty services are free of charge but there is a charge for other services such as transport and packaging costs. Other claims, especially those for damage occurring outside the instrument, are not included unless responsibility is legally binding.

### **After sales service after the warranty time has elapsed**

We are of course there for you even after the warranty time has elapsed. In case of malfunctions, please send us the instrument with a short-form description of the fault. Please do not forget to indicate your telephone number so that we can call you in case of any questions.