

**Additional information for hazardous areas (Ex d). TR12
Resistance thermometers,
TC12 Thermoelectric transmitters. Type of explosion protection -
"flameproof enclosure" (Ex d)**

EN



BVS 07 ATEX E 071 X
IECEx BVS11.0042X



Models TR12-B-xDxx, TC12-B-xDxx

Models TR12-M-xDxx, TC12-M-xDxx

© 03/2019 WIKA Alexander Wiegand SE & Co. KG

All rights reserved.

WIKA® is a registered trademark in various countries.

Prior to any operation, make sure you read the operating instructions carefully!
Store them for later use!

Contents

1. Ex marking	4
2. Safety	5
3. Commissioning,	7
4. Special operation conditions (X conditions)	17
5. Examples of the self-heating calculations for the thermowell tip	18
Annex: EU declaration of conformity	20

For the declaration of conformity, see at www.wika.com.

1. Ex marking

Related documentation:

- ▶ This supplementary information for hazardous areas applies in conjunction with the operating instructions “Resistance thermometer TR12 and thermocouple TC12” (part number 14064370).

EN

1. Ex marking



DANGER!

Hazard from the loss of explosion protection Failure to observe these instructions and their contents may cause the loss of the explosion protection.

- ▶ Read the safety instructions in this section and other instructions in this operating manual.
- ▶ Follow the requirements of the ATEX directive.
- ▶ Follow the instructions contained in the applicable examination certificates and the relevant codes and regulations for the installation of equipment in hazardous areas (e.g. IEC 60079-11, IEC 60079-10 and IEC 60079-14).

Make sure the classification complies with the specific application. Follow the relevant national codes and regulations.

Explosion protection designation

1Ex d IIC T6 ... T1 Gb X / Ex tb IIIC T85 °C Db X, or Ga/Gb

Ex d IIC T6 ... T1 X / Ex tb IIIC T85 °C Db X

For applications without transmitters (digital displays) requiring instruments of equipment group II (potentially explosive gas atmospheres), the following temperature class classification and ambient temperature ranges apply:

Table 1

Marking	Temperature class	Ambient temperature range (T _a)	Max. surface temperature (T _{max}) at the sensor element or thermowell tip area
1Ex d IIC T6 ... T1 Gb X / Ex tb IIIC T85 °C Db X or Ga/Gb Ex d IIC T6 ... T1 X / Ex tb IIIC T85 °C Db X	T6 ... T1	(-60) ¹⁾ -40 ... +80 °C	TM (measured medium temperature) + self-heating Special conditions must be taken into account (see section 4 “Special operating conditions (X-conditions)”).

1) Values in brackets apply to special designs. These sensor elements are manufactured using special sealing compounds. Besides, their housings are made of stainless steel while their cable entries are designed for low-temperature operation ranges.

1. Marking Ex / 2. Safety

If the instrument features a built-in transmitter and/or a digital display, the special conditions in the examination certificate apply (see chapter 4 “Special operating conditions (X-conditions)”).

EN

2. Safety

2.1 Legend



DANGER!

... indicates a potentially dangerous situation in the hazardous area that will result in serious injury or death, if not avoided.

2.2 Purpose

The thermometers described here are suitable for temperature measurement in hazardous areas.

Failure to comply with the instructions for usage of the instrument in hazardous areas can lead to loss of explosion protection. Adhere to the limit values and instructions (see data sheet).

There are 3 various options:

- Option 1: The thermometer is built into a certified ignition protection “flameproof enclosure” type which houses a terminal block inside.
- Option 2: The thermometer is built into a certified ignition protection “flameproof enclosure” type which houses an installed electronic module.
- Option 3: The thermometer is built into a certified device (transmitter) with an ignition protection of “flameproof enclosure” type.

Model TR12-B or TC12-B thermometers in versions 1 and 2 are installed in Ex d certified connection heads or WIKA terminal blocks series 1/4000, 5/6000, or 7/8000. These housings and covers are made of either stainless steel or aluminium. The cover may optionally have a sight glass.

Alternatively, the thermometers may also be installed into other certified housings (see approvals BVS 07 ATEX E 071 X, IECEx BVS 11.0042X “List of WIKA Housings and Instruments”).

Permissible full scale values for the sensor element:

Model TR12: -196 ... +600 °C

Model TC12: -40 ... +1200 °C

2.3 Operator Company Responsibility

Responsibility for the classification of hazardous areas is borne entirely by the operator of the installation and not by the manufacturer/supplier of the equipment.

EN

2.4 Personnel qualification

Trained personnel must have knowledge of the ignition protection classes, codes of practice for the use of the equipment in hazardous areas.

List of possible personnel (user) errors, leading to emergency equipment modes and actions to prevent these errors

Personnel errors are:

1. Electrical connection incorrect. For proper electrical connection, the instructions in the section "Electrical connections" (OI_14064370_TR12_TC12), as well as those in sections 3.3 and 3.5 must be followed.
2. Failure to perform verification and incoming inspection of instruments prior to commissioning.
3. Any actions that can cause the temperature of the instrument surfaces to rise above the values permitted for the specific temperature class. The instrument must be installed in such a way that an increase in ambient temperature would never cause the temperature of the instrument surfaces to rise above the values allowed for the specific temperature class. It is not permitted to install the instrument in direct sunlight or near the heating equipment.
4. Connection of non-certified secondary equipment to these instruments and/or exceeding the permissible parameters of electrical circuits. When connecting, follow the instructions for secondary equipment connection and operation.

2. Safety

2.5 Marking, safety marking

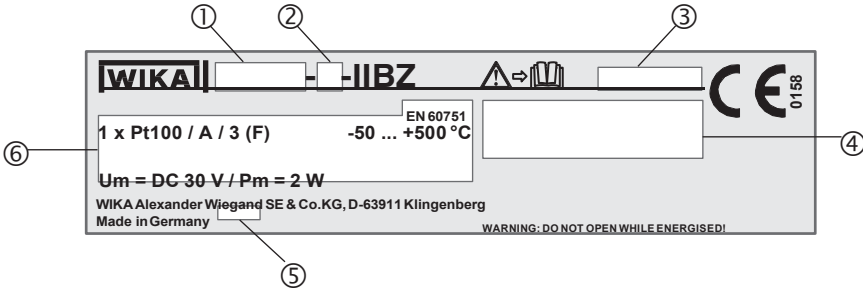

EN



Instrument identification plate (example)

- ① Model
- ② A = measuring insert
B = industrial thermometer
M = basic module
- ③ Serial number
- ④ Information about certificates
- ⑤ Date of manufacture
- ⑥ ■ Information about the device version (measuring element, full scale value, etc.)

Sensor element according to the standard (resistance thermometer)

- F = Thin-film measuring resistor
- W = Wire-wound measuring resistor

Sensor element according to the standard (thermocouple)

- ungrounded  = ungrounded, welded
- grounded  = welded to the enclosure (grounded)
- quasi-grounded  = The thermometer can be considered grounded due to a small insulating gap between the resistive element and enclosure.

- Transmitter Model (Transmitter Design Only)



Read the operating instructions carefully before installing and starting up the measurement instrument!

3. Commissioning, operation

3. Commissioning, operation

EN



DANGER!

Danger to life caused by explosion

When used in flammable environments, there is a danger of explosion that can be fatal.

- ▶ Make all the adjustment operations in non-hazardous areas only!
- ▶ Do not open the instrument while it is energised.



DANGER!

Danger to life caused by explosion

When using a measuring insert without a suitable connection head (case), there is a risk of explosion which can lead to fatal accidents.

- ▶ Use the measuring insert only in the connection head designed for it.



DANGER!

Danger to life from loss of explosion protection Failure to observe the permissible threaded clearances and the corresponding tightening torques can lead to loss of explosion protection.

- ▶ Make sure the number of full continuous threads engaged corresponds to the data provided in section 3.9 and that the tightening torques are consistent with the information in section 2.5 (OI_14064370_TR12_TC12).

Follow the special conditions (see section 4 “Special conditions of use (X conditions)”).

3.1 Mechanical mounting

For pre-assembled connection heads, the direct threaded connection of the thermometer to the connection head or case shall not be turned or opened. Any alignment of the case can only be carried out using the optional neck tube “nipple-union nut-nipple”.

Integration and installation in certified and listed field cases (Option 3) should only be carried out by specialists familiar with the latest technology standards.

Removal and installation of the measuring insert

Before opening the instrument, switch off the voltage and loosen the cover fixing screw (see section 5.2). When replacing the measuring insert, the surfaces of the flameproof joint must not be damaged. Scratches, grooves, notches, irregularities are not permitted. The length and width of the flameproof joint must not be altered.

Mounting and dismounting is described in more detail in section 5.1 (OI_14064370_TR12_TC12).

3. Commissioning, operation

3.2 Locking screw

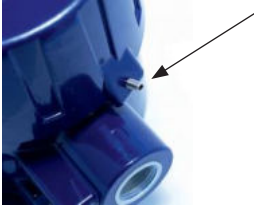

Always tighten the locking screw to prevent accidental opening of the flameproof head.

Always loosen the locking screw to the required extent before opening the head.

3.3 Electrical installation

- Only components (e.g. cables, cable glands, etc.) approved for the “flameproof enclosure” design may be used to install the thermometer.
- Using a transmitter/digital indicator (optional):
 - Follow the instructions in this operating instructions and in the manuals for the transmitter/digital indicator (see the scope of delivery).
 - Observe the relevant regulations for the installation and use of electrical systems, as well as the regulations for explosion protection.
- Temperature resistance of the connecting wires should meet the permissible operating temperature of the cases. For ambient temperatures above 60 °C, temperature-resistant wires must be used.
- Do not install batteries in a flameproof case.
- It is not permitted to install capacitors with a residual energy ≥ 0.02 DJ in an explosion-proof case at the time the case is opened. It is forbidden to open the case during operation. After disconnecting the power supply, wait 2 minutes before opening the case.
- Mounting in metal cases:

The case must be grounded to protect against electromagnetic fields and electrostatic discharge.

It cannot be connected separately to the equipotential bonding system. It is sufficient if the metal thermowell has a tight and reliable contact with the metal chamber or its structural elements or piping, as these parts are connected to the equipotential bonding system.
- Mounting in non-metallic cases:

All thermometer components that conduct electricity and are in a hazardous area must be connected to an equipotential bonding system.

3. Commissioning, operation

3.4.1 Variant 1

EN The thermometer is mounted into a certified ignition protection “flameproof enclosure” type which houses a terminal block inside. The thermometer marked as 1Ex d IIC T6 ... T1 Gb X is intended for use in Zone 1. The thermometer marked as Ga/Gb Ex d IIC T6 ... T1 X is intended for use with a thermowell at the boundary of Zone 0.

► Case or connection head Ex d (with connection terminals, without transmitter)
Assessment of the resistance value or thermoelectric voltage using electronic modules outside the hazardous area.

Usage in zone 1, marking 1Ex d IIC T6 ... T1 Gb X

The flameproof enclosure or a connection head is in zone 1 (or zone 2). The sensor element is located in a safe area.

Usage on the boundary with Zone 0, marking Ga/Gb Ex d IIC T6 ... T1 X

The flameproof enclosure or connection head is in zone 1 (or zone 2). The sensor element is located in a thermowell (min. wall thickness 1 mm), which enters zone 0 through the process connection.

This is the reason for using the thermometer with a power limiting circuit.

P_{\max} : 2 W

U_{\max} : 30 V

An Ex ia power supply meets these conditions, but is not required if the limitation can be achieved by other means. Responsibility lies with the operator company.

The connection head in version 1 does not heat up. However, it is necessary to use appropriate thermal insulation or a sufficiently long extension neck to prevent unacceptable heat transfer back from the process, which could exceed the operating temperature of the housing.

3.4.2 Variant 2

The thermometer is installed in a certified flameproof case of a “flameproof enclosure” type with the electronic modules built-in. The thermometer marked as 1Ex d IIC T6 ... T1 Gb X is intended for use in Zone 1. The thermometer marked as Ga/Gb Ex d IIC T6 ... T1 X is intended for use with a thermowell at the boundary of Zone 0.

► A case or an Ex d connection head with an integrated head transmitter
The assessment is carried out using a current signal (4 ... 20 mA), by a voltage signal (0 ... 10 V), or a field bus signal generated by a transmitter installed in the head.

Usage in zone 1, marking 1Ex d IIC T6 ... T1 Gb X

The flameproof enclosure or a connection head is in zone 1 (or zone 2). The sensor element is located in zone 1.

Usage on the boundary with Zone 0, marking Ga/Gb Ex d IIC T6 ... T1 X

The flameproof enclosure or connection head is in zone 1 (or zone 2). The sensor element is located in a thermowell (min. wall thickness 1 mm), which enters zone 0 via the process connection.

The thermometer should be used with a power limiting circuit.

P_{\max} : 2 W

U_{\max} : 30 V

An Ex ia circuit power supply meets these conditions, but is not required if the limit value can be achieved by other means. Responsibility lies with the operator company.

WIKA recommends limiting the power by using a suitable 4 ... 20 mA fuse installed in the transmitter head.

In case of a failure of the transmitter installed in the head, the circuit should be opened due to the operation of the fuse.

An example of calculating a fuse to ensure maximum power at a 0.8 W sensor element:

The internal resistance of the thermocouple is significantly less than the thermal resistance of the Pt100 sensor element, therefore the calculation of the resistance thermometer is carried out for the worst case.

$$P_{\max} = (1.7 \times I_s)^2 \times R_w$$

I_s = Fuse rating

P_{\max} = maximum power at the sensor element = 0.8 W

R_w = Resistance of the sensor element (as a function of a temperature) at 450 °C = 264.18 Ohm according to DIN EN 60751 for Pt100

3. Commissioning, operation

The fuse rating will be as follows:

$I_s = \text{square root of } (P_{\max} / R_w) / 1.7$

$I_s = \text{square root of } (0.8 \text{ W} / 265 \text{ Ohms}) / 1.7$

$I_s = 32.32 \text{ mA}$

EN As a result, the rated current for the fuse will be = 32 mA

Remarks for the fuse calculation:

Always select a fuse with the next lowest rating in accordance with IEC 60127. Make sure the breaking capacity is suitable for the supply voltage.

Typically, the rated breaking capacity for these fuses is in a range of 20 A to 80 A AC current.

For a maximum sensor element power of 0.5 W, the following values are provided:

$I_s = \text{square root of } (0.5 \text{ W} / 265 \text{ Ohms}) / 1.7$

$I_s = 25.55 \text{ mA}$

As a result, the rated current for the fuse will be = 25 mA

When using multiple sensor elements and simultaneous operation, the sum of the powers of the individual elements must not exceed the value of the maximum permissible power.

Internal resistance of 6 mm diameter TC measuring inserts: approx. 1.2 Ohm/m

Internal resistance of 3 mm diameter TC measuring inserts: approx. 5.6 Ohm/m

These measured values are valid at room temperature.

The following relationships apply to all WIKA connection heads with integrated WIKA temperature transmitters:

The temperature increase at the surface of the connection head or housing is less than 25 K if the following conditions are met: The supply voltage U_B is max. 30 V DC current when the transmitter is operating at a current limitation of 22.5 mA. Heating of the connection head can occur in option 2 due to malfunction of the electronic module. The permissible ambient temperature depends on

the case used and the optional head-mounted transmitter.

However, it is necessary to use the appropriate thermal insulation or a sufficiently long extension neck to prevent unacceptable heat transfer back from the process, which could exceed the operating temperature of the case, or the temperature class.

3.4.3 Variant 3

The thermometer is installed in a certified equipment (transmitter) with a "flameproof enclosure" type and ignition protection. The thermometer is marked 1Ex d IIC T6 ... T1 Gb X and is designed for use in zone 1 with a thermowell. For any possible use on the boundary with zone 0 with a thermowell, the certificates and operating conditions of the respective transmitters must be taken into account.

► Ex d certified temperature transmitters

The calculations are based on a current signal (4 ... 20 mA), a voltage signal (0 ... 10 V) or a field bus signal generated by an ATEX/IECEX Ex d certified temperature transmitter.

Only field transmitters listed in the appendix to the Ex d certificate may be used.

Usage in zone 1, marking 1Ex d IIC T6 ... T1 Gb X

The flameproof enclosure or a connection head is in zone 1 (or zone 2). The sensor element is in zone 1. In case of separation of Ex zones, a thermowell (made of corrosion-resistant steel, min. wall thickness 1 mm) must be used.

The main marking for models TR12-B and TC12-B is located on the certified terminal box or Ex d field transmitter. The TR12-M and TC12-M modules are marked with a foil plate on the neck tube.

For possible use on the boundary of Zone 0 with a thermowell, the certificates and conditions of the Ex d-compliant field transmitters must be observed.

3.5 Electrical installation

Using the transmitter/digital indicator (optional)

Follow the instructions in the manuals for the transmitter/digital indicator (see scope of delivery).

Built-in transmitters/digital indicators have their own expertise certificates. The values for the permissible ambient temperature range of the built-in transmitters can be found in the certificates for the respective transmitters.

Observe the special conditions (see section 4 "Special conditions for use (X conditions)", item 5).

3. Commissioning, operation

Electrical connection features

■ Variant 1

$U_{\max} = 30 \text{ V DC}$ voltage.

Usage in an environment containing methane

Due to the higher value of the minimum ignition energy of methane, the devices can also be used in conditions where methane creates potentially explosive gas atmospheres.

■ Variant 2

$U_{\max} = 30 \text{ V DC}$ voltage.

$P_{\max} = 2 \text{ W}$

■ Variant 3

$U_{\max} =$ depends on the transmitter/digital display

$P_{\max} =$ in housing: depends on the transmitter/digital display

3.6 Classification by temperature class, ambient temperature

The permissible ambient temperatures depend on the temperature class, type of housing used and the optional integrated transmitter and/or digital display.

When a thermometer is connected to a transmitter and/or digital indicator, the shortest ambient temperature range or highest temperature class applies. For special designs, the lower temperature limit is -40 C ; and -60 C .

In the absence of transmitters and digital indicators mounted inside the housing, additional heat is not generated. In the case of an integral transmitter (optional digital display), additional heat may be generated due to the operation of the transmitter or digital display.

For applications without transmitters (digital displays) requiring instruments of equipment group II (potentially explosive gas atmospheres), the following temperature class classification and ambient temperature ranges apply:

Temperature class	Ambient temperature range (T_a)
T1 ... T6	$(-60)^{1)}$ $-40 \dots +80 \text{ C}$

1) Values in brackets apply to special designs. These sensor elements are manufactured using special sealing compounds. Moreover, they feature housings made of stainless steel while their cable glands are designed for low-temperature operation ranges.

The permissible ambient and surface temperature values for products manufactured by other manufacturers can be taken from the respective certificates and/or data sheets, these values must be strictly observed.

3. Commissioning, operation

Example

For instruments with a DIH50 transmitter and digital display, the following temperature class classification restrictions apply:

Temperature class	Ambient temperature range (Ta)
T6	(-60) ¹⁾ -40 ... +60 C

EN

The permissible ambient and surface temperature values for products manufactured by other manufacturers can be taken from the respective certificates and/or data sheets, these values must be strictly observed.

In accordance with the regulations, these thermometers correspond to temperature classes T1 ... T6. They apply to instruments with or without built-in converters and/or digital indicators. Make sure that the maximum ambient temperatures are not exceeded to ensure safe operation of the instrument.

1) Values in brackets apply to special designs. These sensor elements are manufactured using special sealing compounds. Moreover, their housings are made of stainless steel while their cable entries are designed for low-temperature operation ranges.

3.7 Heat transfer from the process

Avoid heat transfer from the process side!

Observe the special conditions (see section 4 "Special conditions for use (X conditions)", item 3).

3. Commissioning, operation

3.8 Overview of temperature zones

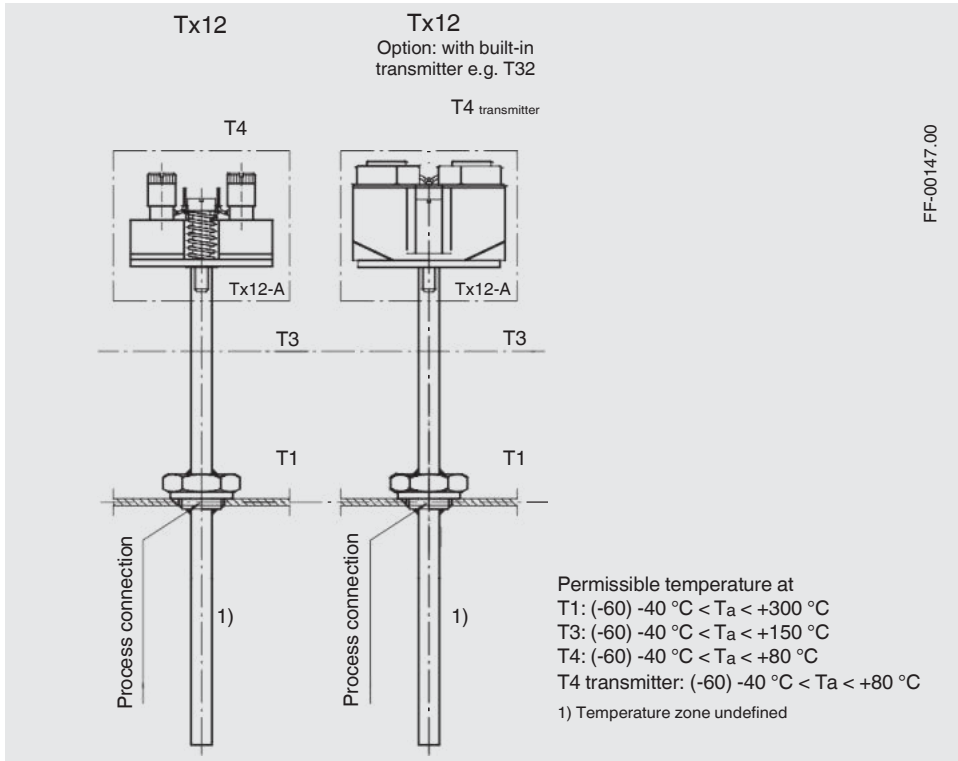

3.9 Thread clearance

The following permitted thread clearances for electrical equipment operating in hazardous gas atmospheres must be ensured for the pipe studs:

- Thread clearance for straight threads (IEC / EN 60079-1 Table 4): Housing volume $\leq 100\text{ cm}^3$: $\geq 5\text{ mm}$
Housing volume $> 100\text{ cm}^3$: $\geq 8\text{ mm}$
There must be at least 5 full continuous threads of thread
- Thread clearance for tapered threads (IEC/EN 60079-1 Table 5): for each component, it is ≥ 5
There must be at least 4.5 full continuous threads of thread

3. Commissioning, operation

3.10 Ensuring the explosion protection of the instrument

The explosion protection of the instrument (Ex d explosion protection) is ensured by enclosing the electrical parts in a explosion proof enclosure which withstands the pressure of an explosion and prevents transmission of the explosion to the surrounding explosive atmosphere.

3.11 Requirements for ensuring that the specifications of the explosion proof equipment are maintained

1. During operation, storage, transportation, devices should not be exposed to mechanical, chemical and other influences that can break the tightness of the case, the condition of cables and cable glands, and cause damage to the insulation.
2. Modifications to the instrument design are not allowed!
3. When using operating devices with “Ex d” type protection, it is necessary to periodically, at least once every 3 months, subject them to external inspection by responsible personnel. During inspection, ensure that:
 - there are no changes or deviations from the normal condition of the equipment;
 - the cable entry is undamaged;
 - unused cable entries are provided with plugs, seals are undamaged, the cover of the housing is tightened all the way;
 - all bolts required by the design are present and properly tightened;
 - the explosion protection marking label is present as well as the warning notice indicating that the cover must not be opened when the instrument is energised.
4. When operating the explosion-protected version of “Ex d” instruments, it is not permitted to:
 - open the enclosure of the instrument whose live parts are energized;
 - carry out any work on an energised instrument;
 - operate the instrument if its enclosure is damaged.

EN

4. Special operation conditions (X conditions)

4. Special operation conditions (X conditions)

- 1) Certified Explosion Proof Model Tx12 Thermometers should only be installed in an approved flameproof enclosure of "flameproof enclosure" type. The certified enclosures to be used are listed in the Appendix "List of ATEX Ex-d enclosures and WIKA devices" (part number: 14011281.07)
- 2) When using thermometers in zone 0, an additional thermowell (made of corrosion-resistant steel, wall thickness 1 mm) must isolate the thermometer from the measured medium, and as a measure to limit the power in the supply circuit, a fuse must be installed upstream of the thermometer. Calculate fuse size as a function of temperature class, process temperature and the power supply (see section 5 for an example calculation).
- 3) Unacceptable heat transfer must be prevented, for example by using suitable thermal insulation or a sufficiently long neck tube. Unacceptable heat transfer can occur if the process temperature exceeds the case operating temperature or temperature class.
- 4) The width of the flameproof joint of this device can be higher, and its clearance can be less than is required according to Table 3 of IEC 60079-1: 2014.
- 5) It is also necessary to strictly adhere to the requirements/conditions of safe use or the operating instructions given in the certificate for each device (transmitter) and housing.
- 6) WIKA housing with terminal box series 5 and series 7 and a window can be operated at operating temperatures of up to 80 °C.

EN

5. Examples of self-heating calculation for a thermowell tip...

5. Examples of self-heating calculation for a thermowell tip

Self-heating around the thermowell tip zone depends on the type of sensor element (RTD/thermocouple), the diameter of the measuring insert and the design of the thermowell. The table below shows the possible combinations. The heating of the probe tip of the measuring insert itself is undoubtedly higher; these values are omitted because the device requires a thermowell.

The table shows that the self-heating of thermocouples is significantly lower than the self-heating of resistance thermometers.

Thermal resistance [R_{th} in K/W]

Sensor design type	Resistance thermometer (RTD)				Thermocouple (TC)			
	2.0 - < 3.0	3.0 - ≤ 6.0	6 - 8	3.0 - 6.0 mm ⁵	0.5 - < 1.5	1.5 - < 3.0	3.0 - < 6.0	6.0 - 12.0
Without thermowell	245	110	75	225	105	60	20	5
With split thermowell (straight and tapered), e.g. TW35, TW40, etc.	135	60	37	-	-	-	11	2.5
With solid-machined thermowell (straight and tapered) such as TW10, TW15, TW20, TW25, TW30, etc.	50	22	16	-	-	-	4	1
Special thermowell according to EN 14597	-	-	33	-	-	-	-	2.5
Tx55 (metal support tube)	-	110	75	225	-	-	20	5
Built into a blind hole (minimum wall thickness 5 mm)	50	22	16	45	22	13	4	1

5.1 Calculation example for option 2 with resistance thermometer

- ▶ Usage at the boundary of Zone 0, marking II 1 / 2G Ex db IIC T1 ... T6 Ga / Gb
Power limiting circuit with 32 mA fuse

If we calculate the maximum permissible temperature T_{max} in the zone of the thermowell tip for the following combination:

- ▶ 6 mm diameter RTD measuring insert with integral head-mounted transmitter in a solid-machined thermowell

T_{max} is calculated by summing the medium temperature and that due to self-heating. Self-heating depends on the power P_o supplied to the transmitter and on the thermal resistance R_{th} . The calculated power supply P_o is taken from the standard value for the fuse chosen and is only released at the probe tip.

5. Self-heating calculation examples ...

EN

The following formula is used for the calculation: $T_{\max} = P_o \cdot R_{\text{th}} + T_M$

T_{\max} = Surface temperature (max. temperature at the thermowell tip zone)

P_o = 0.8 W (32 mA fuse, full transmitter short-circuit assumed)

R_{th} = Thermal resistance [K/W]

T_M = Medium temperature

Example

Resistance thermometer RTD

Diameter: 6 mm

Medium temperature: $T_M = 150\text{ °C}$

Power supplied: $P_o = 0.8\text{ W}$

Temperature class T3 (200 °C) must not be exceeded

Thermal resistance [R_{th} in K/W] from table = 16 K/W

Self-heating: $0.8\text{ W} \cdot 16\text{ K/W} = 12.8\text{ K}$

$T_{\max} = T_M + \text{self-heating: } 150\text{ °C} + 12.8\text{ °C} = 162.8\text{ °C}$

To provide a safety margin for certified devices (for devices from T6 to T3), an additional 5 °C must be subtracted from 200 °C; therefore, a value of 195 °C would be acceptable. This means that the temperature class T3 will not be exceeded in this case.

Further information:

Temperature class for T3 = 200 °C

Safety margin for certified devices (for devices from T3 to T6) ¹⁾ = 5 K

Safety margin for certified devices (for T1 to T2) ¹⁾ = 10 K

The safety margin for devices of category 1 (zone 0) ²⁾ = 80 % is not applicable here

1) EN 60079-0 section 26.5.1.3

2) EN 1127-1: 2011 section 6.4.2

5.2 Calculation example for option 2 with thermocouple

Under the same conditions, calculations give a lower self-heating value as the supplied power is converted into heat not only at the tip of the probe, but also along the entire length of the measuring insert.

Thermal resistance [R_{th} in K/W] from table = 3 K/W

Self-heating: $0.8\text{ W} \cdot 1\text{ K/W} = 0.8\text{ K}$

$T_{\max} = T_M + \text{self-heating: } 150\text{ °C} + 0.8\text{ K} = 150.8\text{ °C}$

To provide a safety margin for certified devices (for devices from T6 to T3), an additional 5 °C must be subtracted from 200 °C; therefore, a value of 195 °C would be acceptable. This means that the temperature class T3 will not be exceeded in this case.

It is clear from this example that the self-heating will be negligible in this case.



EN

EU-Konformitätserklärung EU Declaration of Conformity

Dokument Nr.: 14031790.04
Document No.:



Wir erklären in alleiniger Verantwortung, dass die mit CE gekennzeichneten Produkte
We declare under our sole responsibility that the CE marked products

Typenbezeichnung: TR12-B-ZZ⁽¹⁾, TC12-B-ZZ⁽¹⁾
Type Designation: TR12-B-⁽¹⁾(1), (2), (4), TR12-M-⁽¹⁾(1), (2), (4), TC12-B-⁽¹⁾(1), (2), (4), TC12-M-⁽¹⁾(1), (2), (4)
TR12-B-⁽¹⁾D⁽¹⁾, (3), TR12-M-⁽¹⁾D⁽¹⁾, (3), TC12-B-⁽¹⁾D⁽¹⁾, (3), TC12-M-⁽¹⁾D⁽¹⁾, (3)

Beschreibung: Prozessthermometer Typ TR12 und TC12 zum Einbau in ein Schutzrohr
Description: Process thermometer model TR12 and TC12 for additional thermowell

gemäß gültigem Datenblatt:
according to the valid data sheet: TE 60.17, TE 65.17

die wesentlichen Schutzanforderungen der folgenden Richtlinien erfüllen: Harmonisierte Normen:
comply with the essential protection requirements of the directives: Harmonized standards:

2011/65/EU	Gefährliche Stoffe (RoHS) Hazardous substances (RoHS)	EN 50581:2012
2014/30/EU	Elektromagnetische Verträglichkeit (EMV) ⁽¹⁾ Electromagnetic Compatibility (EMC) ⁽¹⁾	
2014/34/EU	Explosionsschutz (ATEX) ^{(2), (3), (4)} Explosion protection (ATEX) ^{(2), (3), (4)}	
	II 1G Ex ia IIC T1, T2, T3, T4, T5, T6 Ga or II 1/2G Ex ia IIC T1, T2, T3, T4, T5, T6 Ga/Gb or II 2G Ex ia IIC T1, T2, T3, T4, T5, T6 Gb or II 2G Ex ib IIC T1, T2, T3, T4, T5, T6 Gb	⁽²⁾ EN 60079-0:2012 +A11:2013 EN 60079-11:2012 EN 60079-26:2015
	II 2G Ex db IIC T6-T1 Gb or II 1/2G Ex db IIC T6-T1 Ga/Gb or II 2G Ex db IIC Gb	⁽³⁾ EN 60079-0:2012 +A11:2013 EN 60079-1:2014 EN 60079-26:2015
	II 3G Ex ic IIC T1, T2 T3, T4, T5, T6 Gc	⁽⁴⁾ EN 60079-0:2012 +A11:2013 EN 60079-11:2012

- (1) Für optional eingebaute Transmitter oder Anzeigen gelten deren EU-Konformitätserklärungen und die darin gelisteten Normen
For optional built-in transmitters and indicators their respective EU declarations of conformity and the therein listed standards apply
- (2) EG-Baumusterprüfbescheinigung TÜV 10 ATEX 555793 X von TÜV NORD CERT GmbH, D-45141 Essen (Reg.-Nr. 0044)
EC type-examination certificate TÜV 10 ATEX 555793 X of TÜV NORD CERT GmbH, D-45141 Essen (Reg. no. 0044)
- (3) EU-Baumusterprüfbescheinigung BVS 07 ATEX E 071 X von DEKRA EXAM GmbH, D-44809 Bochum (Reg. Nr. 0158)
EU type examination certificate BVS 07 ATEX E 071 X of DEKRA EXAM GmbH, D-44809 Bochum (Reg. No. 0158)
- (4) Modul A, interne Fertigungskontrolle
Module A, internal control of production

Unterzeichnet für und im Namen von / Signed for and on behalf of

WIKAI Alexander Wiegand SE & Co. KG

Klingenberg, 2017-07-11

Stefan Heidinger, Vice President
Electrical Temperature Measurement

Franz-Josef Vogel, Executive Vice President
Process Instrumentation

WIKAI Alexander Wiegand SE & Co. KG
Alexander-Wiegand-Straße 30
63911 Klingenberg
Germany

Tel. +49 9372 132-0
Fax +49 9372 132-406
E-Mail info@wika.de
www.wika.de

Kommanditgesellschaft, Sitz Klingenberg –
Amtsgericht Aschaffenburg HRA 1819
Komplementärin: WIKAI Verwaltings SE & Co. KG –
Sitz Klingenberg – Amtsgericht Aschaffenburg
HRA 4685

Komplementärin:
WIKAI International SE – Sitz Klingenberg –
Amtsgericht Aschaffenburg HRB 10505
Vorstand: Alexander Wiegand
Vorsitzender des Aufsichtsrats: Dr. Max Egli

08/2021 EN based on 14280101.01 03/2019 RU

