

Instruction manual

Flow Sensor

IVA 550



I. Foreword

Dear customer,

thank you very much for deciding in favour of the IVA 550. Please read this installation and operation manual carefully before mounting and initiating the device and follow our advice. A riskless operation and a correct functioning of the IVA 550 are only guaranteed in case of careful observation of the described instructions and notes



ICS Schneider Messtechnik GmbH
Briesestraße 59
D-16562 Hohen Neuendorf / OT Bergfelde

Tel.: 03303 / 50 40 66
Fax: 03303 / 50 40 68

info@ics-schneider.de
www.ics-schneider.de

II. Table of Content

I.	Foreword	2
1	Pictograms and Symbols	5
2	Signalwords according ISO 3864 and ANSI Z 535	5
3	Safety instructions	6
3.1	Intended Use	7
3.2	Installation and commissioning	7
4	Technical data	8
4.1	Signal circuits	9
4.1.1	Modbus	9
4.1.2	Current output	9
4.1.2.1	Aktive	9
4.1.2.2	Passive	9
4.1.3	Pulse	9
4.1.4	Alarm	9
4.2	Measuring range flow IVA 550	10
4.2.1	Maximum Flow Ranges „Low Speed“	11
4.2.2	Measuring range „Standard Version“	13
4.2.3	Measuring range „Max Version“	15
4.2.4	Measuring range „High Speed Version“	17
5	Dimensions	19
5.1	Dimension IVA 550	19
6	Installation	20
6.1	Pipe/tube requirements	20
6.2	Inlet / outlet runs	20
6.3	Installation IVA 550	21
6.3.1	1/2“ welded nipple with ball valve 1/2“	21
6.3.2	Spot drilling collar with ball valve	21
6.4	Installation of the Sensor	22
6.4.1	Mounting IVA 550 onto the ball valve	22
6.5	Alignement Display (Housing)	23
6.6	Tightening torques	23
7	Connection diagram	24
7.1	Cable glands - clamping ranges	24
7.2	Connector pin assignment	24
7.3	Wire connection	26
7.3.1	General	26
7.3.2	Power supply	26
7.3.3	Modbus RTU:	26
7.3.4	Modbus TCP (Ethernet) Optional PoE	27
7.3.5	Pulse Output	27

8	Operation IVA 550	28
8.1	Main menu (Home)	29
8.1.1	Intialization	29
8.2	Main menu	29
8.3	Settings	30
8.3.1	Sensor Setup	31
8.3.1.1	Input / change tube diameter	31
8.3.1.2	Input / change consumption counter	32
8.3.1.3	Definition of the units for flow, velocity, temperature and pressure	32
8.3.1.4	Definition of the reference conditions	33
8.3.1.5	Setting of Zeropoint and Low-flow cut off	35
8.3.2	Modbus RTU	36
8.3.2.1	Setup	36
8.3.3	Modbus TCP (Optional)	37
8.3.3.1	Setup	37
8.3.3.1.1	Network Setup DHCP	37
8.3.3.1.2	Network Settings static IP	38
8.3.3.1.3	Modbus TCP Settings	39
8.3.3.2	Modbus Settings (2001...2005)	40
8.3.3.3	Values Register (1001 ...1500)	40
8.3.4	Pulse /Alarm	42
8.3.4.1	Pulse output	42
8.3.5	User Setup	43
8.3.5.1	Password	43
8.3.5.2	Language	43
8.3.5.3	Display / Touch	44
8.3.6	Advanced	44
8.3.7	4 -20mA	45
8.3.8	IVA 550 Info	47
8.4	MBus	48
8.4.1	Change of communication settings	48
8.4.2	Coding VIF (Value Information Field)	49
8.4.3	Default Settings communication	49
8.4.4	Default values transmitted	49
9	Supplementary Documentation	49

1 Pictograms and Symbols



General Warning symbol (Danger, Warning, Caution)



General note



Installation- and Instruction manual to consider (on Nameplate)



Installation- and Instruction manual to consider

2 Signalwords according ISO 3864 and ANSI Z 535

Danger!	Imminent danger As a consequence of incorrect handling: serious personal injury or death
Warning!	Possible hazard As a consequence of incorrect handling: possible serious injury or death
Caution!	Imminent hazard As a consequence of incorrect handling: possible personal injury or damage
Note!	Possible hazard As a consequence of incorrect handling: possible personal injury or damage
Important!	Additional notes, information, tips As a consequence of incorrect handling: Disadvantages in operation and maintenance, no danger

3 Safety instructions



Please check whether this manual corresponds with the device type.

Please attend to all notes indicated in this instruction manual. It contains essential information, which has to be followed during installation, operation and maintenance. Therefore this instruction manual has to be read categorically by the technician as well as by the responsible user/qualified personnel before installation, initiation and maintenance

Regional and national regulations respectively, have to be observed in addition to this instruction manual if necessary.

This instruction manual has to be available at any time at the operation site of the IVA 550.

Ensure that the IVA 550 operates within the permissible and listed limits on the nameplate. Otherwise there is a risk to human and material, and it may occur functional and operational disturbances

In case of any obscurities or questions with regard to this manual or the instrument please contact .



Warning!

Risk of injury in case of inadequate qualification!

Improper handling can result in significant personal injury and damage.

All activities described in this operating instructions manual must be carried out only by qualified personnel qualifications described below.

Professionals (Technical staff)

The technical staff is based on his education/training, his knowledge of measurement and control technology as well of the local regulations, standards and guidelines in the position to do the work as described and to identify the possible hazards.

Special working conditions require further appropriate knowledge, e.g. of aggressive media.



Caution!

Malfunction of IVA 550

Faulty installation and insufficient maintenance may lead to malfunctions of the IVA 550 which may affect the display and open to misinterpretation.



Danger!

Inadmissible operating parameters!

By exceeding or falling short of limits there is a risk for people and material, in addition there may occur further functional and operational disturbances.

Measures:

- Make sure that the IVA 550 operates only within the permissible and listed limits on the nameplate
 - Ensure the operation within the performance data of IVA 550 in connection with the application
- Additional safety information:**

- Do not exceed the admissible storage and transportation temperature.
- When installing and operating the relevant national regulations and safety rules must also be observed.



In gas hazardous areas (explosive media) only the version IVA 550 EX must be used.

When using the Flow-/ Consumption sensors IVA 550 Ex in gas hazardous areas the special requirements specified in the Ex documentation must be observed.

3.1 Intended Use

The instrument described in this manual is exclusively to use for measuring the thermal mass flow of gases. At the same time, the gas temperature is measured too.

The IVA 550 can be configured for measuring a predetermined range of pure gases or of gas mixtures.

Consumption measurement of gases such as Air, oxygen, nitrogen, carbon dioxide, argon, etc. and with ATEX approval explosive gases such as natural gas, methane, propane and hydrogen.

Improper or incorrect use the operational reliability will be canceled. The manufacturer is not liable for any damage resulting by improper or incorrect use.

3.2 Installation and commissioning

- Installation, electrical installation, commissioning, operation and maintenance of the device must only be carried by qualified personnel, which were authorized by the plant operator. The personnel must read the operating instructions and understand and follow their instructions.
- If carrying out welding work on the pipeline the grounding of the welding unit is not allowed to be done over the IVA 550 itself.
- The installer has to ensure that the IVA 550 is connected according to the electrical connection diagrams properly. The sensor must be grounded, unless special protective measures have been taken (e.g. galvanically isolated power supply)
- The existing/ applicable national regulations governing opening and repair of the device have to be applied.
- When using the IVA 550 (ATEX Version) hazardous areas, in addition with the standard manual a separate Ex documentation is enclosed. The installation instructions and connection values indicated in these must also be observed.
- The device fulfills the general safety requirements in accordance with EN 61010-1, the EMC requirements of IEC / EN 61326 and NAMUR recommendation NE 43.

4 Technical data

Measures:	mass flow, consumption flow speed, temperature
Measuring principle:	thermal mass flow sensor
Medium temperature range:	-40 ... 180°C Probe (ATEX-Version -20°C ... 120°C)
Operating temperature range:	-20 ... 70 °C
Operating pressure:	50 bar
Power supply:	18 ... 36 VDC Optional: PoE according to IEEE 802.3af, PD Class 2 (max. 6.5W), voltage from 36V to 57V DC
Power consumption:	max. 5W
Output:	Modbus RTU (acc. EIA/TIA-485 Standard) 2 x 4...20 mA active (optional passive) RL < 500Ohm galvanically isolated pulse (Pulse weight freely selectable, Alarm max. 48Vdc 0,5A <u>Relay: Normally Closed</u>) optional: Modbus TCP, HART, ProfibusDP, Profi Net,
Accuracy: Standard version* (m.v. of meas. value) (f.s. of full scale)	± 1,5 % m.v. ± 0,3 % f.s.
Accuracy: Precision version* (m.v. of meas. value) (f.s. of full scale)	± 1,0 % m.v. ± 0,3 % f.s.
Repeatability :	0,25% m.v in case of correct mounting(mounting aid, position, inlet section
Accuracy indications:	referred to ambient temperature 22°C +/-2°C, system pressure 6bar
Response time:	t90 < 3s
Display:	2" TFT Color Display (320 x 240)
Screw in thread:	G 1/2" ISO 228, NPT 1/2", R 1/2", PT 1/2"
Material:	Housing aluminum die cast, probe stainless steel1,4571
Protection class	IP67

* Reference conditions for Temperature and pressure can be freely set, standard conditions are 0 ° and 1013 mbar.

4.1 Signal circuits

4.1.1 Modbus

- According Standard EIA/TIA-485

4.1.2 Current output

4.1.2.1 Aktive

- Galvanically isolated
- 4 ... 20 mA
- $R_L < 500 \text{ Ohm}$

4.1.2.2 Passive

- Galvanically isolated
- 4 ... 20 mA
- $R_L < 500 \text{ Ohm}$
- $V_{in} 12\text{-}36\text{Vdc}$

4.1.3 Pulse

- Galvanically isolated (dry contact)
- Passive: 48Vdc , 500 mA
- Max. pulse output freq. 50Hz

4.1.4 Alarm

- Galvanically isolated
- Max. 48Vdc, 500mA

4.2 Measuring range flow IVA 550

The flow-/consumption sensor IVA 550 is available in 4 different versions:

- | | |
|----------------------|-----------------------------------|
| • Low Speed | max. measuring range of 50 m/s |
| • Standard | max. measuring range of 92,7 m/s |
| • Max-Version | max. measuring range of 185.0 m/s |
| • High speed-Version | max. measuring range of 224 m/s |

The sensors are **programmed to pipe inner diameter of 53,1 mm.**

	Measuring range	Analogue output Scaling
• Low Speed	0... 323,6 m ³ /h	4mA = 0 m ³ h, 20mA = 323,6 m ³ /h
• Standard	0 ... 600 m ³ /h	4mA = 0 m ³ h, 20mA = 600 m ³ /h
• Max-Version	0 ... 1197,59 m ³ /h	4mA = 0 m ³ h, 20mA = 1197,59 m ³ /h
• Highspeed-Version	0 ... 1450,06 m ³ /h	4mA = 0 m ³ h, 20mA = 1450,06 m ³ /h

In case of use in **other** inner pipe diameter the diameter, using the display version, the diameter has to be set first.

The corresponding scale values for the respective version could be found in sections 4.2.1 to 4.2.4.

Example:

Pipe 1", Inner diameter 25mm

	Measuring range	Analogue output Scaling
• Low Speed	0 ... 65,9 m ³ /h	4mA = 0 m ³ h, 20mA = 65,9 m ³ /h
• Grundversion(Standard)	0 ... 122,2 m ³ /h	4mA = 0 m ³ h, 20mA = 122,2 m ³ /h
• Max-Version	0 ... 243,88 m ³ /h	4mA = 0 m ³ h, 20mA = 243,88 m ³ /h
• Highspeed-Version	0 ... 295,30 m ³ /h	4mA = 0 m ³ h, 20mA = 295,30 m ³ /h

For changing the inner pipe diameter and adjusting the 4...20mA scaling, please refer to chapter "Operation".

4.2.1 Measuring range „Low Speed“

Inner diameter of the pipe		Low Speed (50 m/s)							
		Full scale value in in Nm ³ /h							
Inch	mm	Air ²⁾	160mm	Ar ³⁾	CO ₂ ³⁾	N ₂ ³⁾	O ₂ ³⁾	N ₂ O ³⁾	Natural gas ³⁾
1/2"	16,1	24,6	22,6	38,4	24,3	22,6	23,4	24,1	14,6
3/4"	21,7	48,1	44,2	75,1	47,6	44,2	45,8	47,1	28,4
1"	25,0	65,9	60,6	103,1	65,2	60,6	62,8	64,6	39,0
	26,0	71,7	65,9	112,1	70,9	65,9	68,3	70,3	42,4
	27,3	79,7	73,2	124,5	78,8	73,2	75,9	78,1	47,1
	28,5	87,4	80,4	136,6	86,5	80,4	83,3	85,7	51,7
	30,0	97,6	89,7	152,6	96,6	89,7	93,0	95,7	57,7
1 1/4"	32,8	118,0	108,5	184,5	116,8	108,5	112,5	115,8	69,8
	36,0	143,6	132,1	224,6	142,1	132,1	136,9	140,9	85,0
	36,3	146,2	134,5	228,6	144,7	134,5	139,4	143,4	86,5
1 1/2"	39,3	172,9	159,0	270,4	171,1	159,0	164,9	169,6	102,3
	40,0	179,4	164,9	280,4	177,5	164,9	171,0	175,9	106,1
	41,9	196,9	181,0	307,8	194,8	181,0	187,7	193,1	116,5
	43,1	210,1	193,2	328,5	207,9	193,2	200,3	206,1	124,3
	45,8	238,4	219,3	372,8	235,9	219,3	227,3	233,8	141,1
2"	50,0	286,3	263,3	447,6	283,3	263,3	272,9	280,8	169,4
	51,2	300,6	276,4	469,9	297,4	276,4	286,5	294,8	177,9
	53,1	323,7	297,6	506,1	320,3	297,6	308,6	317,5	191,5
	54,5	341,4	313,9	533,8	337,8	313,9	325,5	334,8	202,0
	57,5	403,1	370,7	630,3	399,0	370,7	384,4	395,4	238,6
	60,0	417,3	383,8	652,5	413,0	383,8	397,9	409,3	247,0
	64,2	479,5	441,0	749,8	474,6	441,0	457,2	470,3	283,8

²⁾ Referred to DIN 1945 / ISO 1217 (20°C, 1000mbar) and compressed air.

³⁾ Referred to DIN 1343: 0°C, 1013,25 mbar

Measuring range

Inner diameter of the pipe		Low Speed (50 m/s)							
		Full scale value in in Nm ³ /h							
Inch	mm	Air ²⁾	Air ³⁾	Ar ³⁾	CO ₂ ³⁾	N ₂ ³⁾	O ₂ ³⁾	N ₂ O ³⁾	Natural gas ³⁾ Methan
2 1/2"	65,0	492,2	452,6	769,5	487,1	452,6	469,2	482,7	291,2
	70,3	577,8	531,3	903,4	571,8	531,3	550,9	566,7	341,9
	71,1	591,0	543,5	924,1	584,9	543,5	563,5	579,7	349,7
	76,1	678,7	624,1	1061,2	671,7	624,1	647,1	665,7	401,6
3"	80,0	751,9	691,4	1175,5	744,1	691,4	716,8	737,4	444,9
	82,5	799,6	735,3	1250,2	791,3	735,3	762,3	784,2	473,2
	84,9	846,8	778,7	1324,0	838,0	778,7	807,3	830,5	501,1
	90,0	952,7	876,1	1489,6	942,8	876,1	908,3	934,4	563,8
4"	100,0	1177,6	1082,9	1841,2	1165,4	1082,9	1122,7	1155,0	696,9
	107,1	1352,4	1243,7	2114,5	1338,4	1243,7	1289,4	1326,4	800,3
	110,0	1426,6	1311,9	2230,5	1411,8	1311,9	1360,2	1399,2	844,2
	125,0	1844,5	1696,1	2883,8	1825,3	1696,1	1758,5	1809,0	1091,5
5"	133,7	2110,1	1940,5	3299,2	2088,2	1940,5	2011,8	2069,6	1248,7
	150,0	2659,2	2445,4	4157,6	2631,6	2445,4	2535,3	2608,1	1573,6
	159,3	2999,2	2758,0	4689,2	2968,0	2758,0	2859,4	2941,6	1774,8
	182,5	3941,1	3624,2	6161,8	3900,1	3624,2	3757,4	3865,4	2332,1
6"	190,0	4271,6	3928,2	6678,7	4227,3	3928,2	4072,6	4189,6	2527,8
	200,0	4738,8	4357,7	7409,0	4689,5	4357,7	4517,9	4647,7	2804,2
	206,5	5051,8	4645,6	7898,4	4999,3	4645,6	4816,4	4954,8	2989,4
	250,0	7413,2	6817,1	11590,4	7336,1	6817,1	7067,7	7270,8	4386,8
10"	260,4	8052,4	7404,9	12589,8	7968,7	7404,9	7677,1	7897,7	4765,0
	300,0	10687,7	9828,3	16710,1	10576,6	9828,3	10189,6	10482,4	6324,5
	309,7	11390,0	10474,2	17808,1	11271,6	10474,2	10859,2	11171,2	6740,1
	339,6	13695,5	12594,2	21412,7	13553,1	12594,2	13057,2	13432,4	8104,4
12"	400,0	19000,4	17472,6	29706,8	18802,9	17472,6	18114,9	18635,4	11243,6
	500,0	29688,1	27300,9	46416,9	29379,5	27300,9	28304,5	29117,7	17568,1
	600,0	42750,8	39313,3	66840,4	42306,5	39313,3	40758,4	41929,6	25298,0
	700,0	58188,6	53509,8	90977,1	57583,9	53509,8	55476,8	57070,8	34433,4
	800,0	76001,4	69890,3	118827,3	75211,6	69890,3	72459,4	74541,4	44974,3
	900,0	96189,3	88454,9	150390,8	95189,7	88454,9	91706,5	94341,5	56920,6
	1000,0	118752,2	109203,6	185667,6	117518,1	109203,6	113217,9	116471,0	70272,3

²⁾ Referred to DIN 1945 / ISO 1217 (20°C, 1000mbar) and compressed air.

³⁾ Referred to DIN 1343: 0°C, 1013,25 mbar

4.2.2 Measuring range „Standard Version“

Innerradius of pipe		Standard Version (92,7 m/s)							
		Full scale value in in Nm ³ /h							
Inch	mm	Air ²⁾	Air ³⁾	Ar ³⁾	CO ₂ ³⁾	N ₂ ³⁾	O ₂ ³⁾	N ₂ O ³⁾	Methane ³⁾ Natural gas ³⁾
1/2"	16,1	45,6	41,9	71,3	45,1	41,9	43,4	44,7	27,0
3/4"	21,7	89,1	81,9	139,3	88,2	81,9	84,9	87,4	52,7
1"	25,0	122,2	112,4	191,1	120,9	112,4	116,4	119,9	72,3
	26,0	132,9	122,2	207,8	131,5	122,2	126,5	130,3	78,6
	27,3	147,7	135,8	230,9	146,1	135,8	140,6	144,8	87,4
	28,5	162,0	149,0	253,3	160,3	149,0	154,3	158,9	95,9
1 1/4"	30,0	180,9	166,4	282,9	179,0	166,4	172,3	177,5	107,1
	32,8	218,8	201,2	342,1	216,5	201,2	208,4	214,6	129,5
	36,0	266,3	244,9	416,4	263,5	244,9	253,6	261,2	157,6
	36,3	271,1	249,3	423,9	268,3	249,3	258,2	265,9	160,4
1 1/2"	39,3	320,6	294,8	501,3	317,3	294,8	305,3	314,5	189,7
	40,0	332,6	305,8	519,9	329,1	305,8	316,7	326,2	196,8
	41,9	365,0	335,6	570,6	361,2	335,6	347,6	358,0	216,0
	43,1	389,5	358,2	609,0	385,4	358,2	370,9	382,0	230,5
2"	45,8	442,0	406,5	691,1	437,4	406,5	421,0	433,5	261,6
	50,0	530,8	488,1	829,8	525,2	488,1	505,5	520,6	314,1
	51,2	557,2	512,4	871,2	551,4	512,4	530,7	546,5	329,7
	53,1	600,1	551,8	938,2	593,8	551,8	571,5	588,6	355,1
	54,5	632,9	582,0	989,5	626,3	582,0	602,7	620,8	374,5
	57,5	747,4	687,3	1168,5	739,6	687,3	711,8	733,1	442,3
	60,0	773,7	711,5	1209,7	765,6	711,5	736,8	758,9	457,9
	64,2	889,1	817,6	1390,0	879,8	817,6	846,7	872,0	526,1

²⁾ Referred to DIN 1945 / ISO 1217 (20°C, 1000mbar) and compressed air.

³⁾ Referred to DIN 1343: 0°C, 1013,25 mbar

Measuring range

Innerradius of pipe		Standard Version (92,7 m/s)							
		Full scale value in in Nm ³ /h							
Inch	mm	Air ²⁾	Air ³⁾	Ar ³⁾	CO ₂ ³⁾	N ₂ ³⁾	O ₂ ³⁾	N ₂ O ³⁾	Methane ³⁾ Natural gas ³⁾
2 1/2"	65,0	912,5	839,1	1426,6	902,9	839,1	869,0	895,0	540,0
	70,3	1071,2	985,1	1674,8	1060,0	985,1	1020,2	1050,7	633,9
	71,1	1095,8	1007,7	1713,1	1084,3	1007,7	1043,5	1074,7	648,4
3"	76,1	1258,3	1157,2	1967,3	1245,2	1157,2	1198,3	1234,2	744,6
	80,0	1394,0	1281,9	2179,4	1379,4	1281,9	1327,5	1367,2	824,9
	82,5	1482,5	1363,3	2317,7	1466,9	1363,3	1411,8	1454,0	877,2
4"	84,9	1570,0	1443,7	2454,5	1553,5	1443,7	1495,1	1539,8	929,0
	90,0	1766,4	1624,3	2761,6	1747,9	1624,3	1682,1	1732,4	1045,3
	100,0	2183,3	2007,8	3413,5	2160,5	2007,8	2079,2	2141,4	1292,0
5"	107,1	2507,4	2305,7	3920,1	2481,1	2305,7	2387,8	2459,2	1483,7
	110,0	2645,0	2432,3	4135,3	2617,3	2432,3	2518,9	2594,2	1565,2
	125,0	3419,6	3144,7	5346,3	3383,8	3144,7	3256,6	3353,9	2023,6
6"	133,7	3912,2	3597,6	6116,5	3871,3	3597,6	3725,7	3837,0	2315,1
	150,0	4930,2	4533,7	7708,0	4878,6	4533,7	4695,1	4835,4	2917,4
	159,3	5560,5	5113,3	8693,4	5502,3	5113,3	5295,3	5453,6	3290,4
8"	182,5	7306,7	6719,2	11423,6	7230,3	6719,2	6958,3	7166,4	4323,8
	190,0	7919,6	7282,8	12381,8	7836,8	7282,8	7542,0	7767,5	4686,5
	200,0	8785,7	8079,2	13735,8	8693,8	8079,2	8366,8	8616,9	5199,0
10"	206,5	9366,0	8612,9	14643,2	9268,0	8612,9	8919,4	9186,1	5542,4
	250,0	13744,0	12638,9	21487,8	13600,2	12638,9	13088,7	13480,0	8133,1
	260,4	14929,1	13728,7	23340,6	14772,9	13728,7	14217,2	14642,3	8834,4
12"	300,0	19815,0	18221,7	30979,4	19607,7	18221,7	18870,1	19434,3	11725,6
	309,7	21117,1	19419,1	33015,1	20896,1	19419,1	20110,1	20711,4	12496,1
	339,6	25391,4	23349,7	39697,7	25125,7	23349,7	24180,6	24903,6	15025,5
15"	400,0	35226,7	32394,1	55074,4	34858,0	32394,1	33546,9	34549,9	20845,6
	500,0	55041,6	50615,8	86053,8	54465,7	50615,8	52417,0	53984,3	32571,2
	600,0	79260,0	72886,8	123917,4	78430,6	72886,8	75480,5	77737,4	46902,5
18"	700,0	107881,6	99207,0	168665,4	106752,8	99207,0	102737,4	105809,2	63839,5
	800,0	140906,6	129576,5	220297,7	139432,2	129576,5	134187,6	138199,7	83382,2
	900,0	178334,9	163995,2	278814,3	176468,9	163995,2	169831,2	174909,1	105530,6
24"	1000,0	220166,6	202463,2	344215,1	217862,8	202463,2	209668,2	215937,1	130284,7

²⁾ Referred to DIN 1945 / ISO 1217 (20°C, 1000mbar) and compressed air.

³⁾ Referred to DIN 1343: 0°C, 1013,25 mbar

4.2.3 Measuring range „Max Version“

Innerradius of pipe		Max Version (185,0 m/s)							
		Full scale value in in Nm ³ /h							
Inch	mm	Air ²⁾	Air ³⁾	Ar ³⁾	CO ₂ ³⁾	N ₂ ³⁾	O ₂ ³⁾	N ₂ O ³⁾	Methane ³⁾ Natural gas ³⁾
1/2"	16,1	91,0	83,7	142,2	90,0	83,7	86,7	89,2	53,8
3/4"	21,7	177,8	163,5	278,0	176,0	163,5	169,5	174,4	105,2
1"	25,0	243,9	224,3	381,3	241,3	224,3	232,5	239,2	144,3
	26,0	265,2	243,9	414,6	262,4	243,9	252,8	260,1	156,9
	27,3	294,7	271,0	460,8	291,7	271,0	281,0	289,1	174,4
	28,5	323,3	297,3	505,5	320,0	297,3	308,3	317,1	191,3
	30,0	361,1	332,0	564,5	357,3	332,0	344,3	354,1	213,7
1 1/4"	32,8	436,7	401,6	682,8	432,2	401,6	416,3	428,3	258,4
	36,0	531,5	488,7	831,0	526,0	488,7	506,7	521,3	314,5
	36,3	541,1	497,6	845,9	535,4	497,6	515,8	530,7	320,2
1 1/2"	39,3	639,8	588,4	1000,4	633,2	588,4	610,0	627,6	378,6
	40,0	663,7	610,3	1037,7	656,8	610,3	632,7	650,9	392,7
	41,9	728,4	669,8	1138,9	720,8	669,8	694,5	714,4	431,0
	43,1	777,3	714,8	1215,4	769,3	714,8	741,1	762,4	460,0
	45,8	882,2	811,2	1379,3	873,0	811,2	841,1	865,2	522,0
2"	50,0	1059,2	974,1	1656,1	1048,2	974,1	1009,9	1038,9	626,8
	51,2	1112,1	1022,6	1738,7	1100,5	1022,6	1060,2	1090,7	658,1
	53,1	1197,6	1101,3	1872,4	1185,1	1101,3	1141,8	1174,6	708,7
	54,5	1263,1	1161,6	1974,9	1250,0	1161,6	1204,3	1238,9	747,5
	57,5	1491,6	1371,7	2332,1	1476,1	1371,7	1422,1	1463,0	882,7
	60,0	1544,1	1420,0	2414,2	1528,1	1420,0	1472,2	1514,5	913,7
	64,2	1774,3	1631,7	2774,1	1755,9	1631,7	1691,6	1740,2	1050,0

²⁾ Referred to DIN 1945 / ISO 1217 (20°C, 1000mbar) and compressed air.

³⁾ Referred to DIN 1343: 0°C, 1013,25 mbar

Measuring range

Innerdiameter of pipe		Max Version (185,0 m/s)							
		Full scale value in in Nm ³ /h							
Inch	mm	Air ²⁾	Air ³⁾	Ar ³⁾	CO ₂ ³⁾	N ₂ ³⁾	O ₂ ³⁾	N ₂ O ³⁾	Methane ³⁾ Natural gas ³⁾
2 1/2"	65,0	1821,0	1674,6	2847,2	1802,1	1674,6	1736,2	1786,1	1077,6
	70,3	2137,9	1966,0	3342,5	2115,6	1966,0	2038,2	2096,8	1265,1
	71,1	2186,8	2011,0	3419,0	2164,1	2011,0	2084,9	2144,8	1294,0
	76,1	2511,2	2309,3	3926,3	2485,1	2309,3	2394,2	2463,0	1486,0
3"	80,0	2781,9	2558,2	4349,5	2753,0	2558,2	2652,3	2728,5	1646,2
	82,5	2958,5	2720,6	4625,6	2927,8	2720,6	2820,6	2901,7	1750,7
	84,9	3133,1	2881,2	4898,6	3100,6	2881,2	2987,1	3073,0	1854,1
	90,0	3525,1	3241,7	5511,5	3488,5	3241,7	3360,8	3457,4	2086,0
4"	100,0	4357,2	4006,9	6812,5	4311,9	4006,9	4154,1	4273,5	2578,4
	107,1	5003,9	4601,5	7823,5	4951,9	4601,5	4770,7	4907,8	2961,1
	110,0	5278,6	4854,1	8253,0	5223,7	4854,1	5032,6	5177,2	3123,6
	125,0	6824,5	6275,7	10670,0	6753,6	6275,7	6506,4	6693,4	4038,4
5"	133,7	7807,5	7179,7	12207,0	7726,4	7179,7	7443,7	7657,5	4620,1
	150,0	9839,0	9047,9	15383,2	9736,8	9047,9	9380,5	9650,0	5822,3
	159,3	11096,9	10204,6	17349,9	10981,6	10204,6	10579,7	10883,7	6566,7
	182,5	14581,9	13409,4	22798,7	14430,4	13409,4	13902,4	14301,8	8628,9
6"	190,0	15805,1	14534,2	24711,1	15640,8	14534,2	15068,5	15501,5	9352,7
	200,0	17533,5	16123,6	27413,4	17351,3	16123,6	16716,3	17196,7	10375,5
	206,5	18691,7	17188,7	29224,2	18497,4	17188,7	17820,6	18332,6	11060,9
	250,0	27428,8	25223,2	42884,5	27143,7	25223,2	26150,4	26901,8	16231,1
8"	260,4	29793,8	27398,1	46582,2	29484,2	27398,1	28405,2	29221,4	17630,6
	300,0	39544,5	36364,7	61827,4	39133,6	36364,7	37701,5	38784,8	23400,7
	309,7	42143,0	38754,3	65890,2	41705,1	38754,3	40179,0	41333,5	24938,4
	339,6	50673,3	46598,7	79227,1	50146,7	46598,7	48311,6	49699,8	29986,2
10"	400,0	70301,3	64648,4	109915,3	69570,8	64648,4	67024,9	68950,8	41601,2
	500,0	109845,8	101013,2	171742,6	108704,3	101013,2	104726,4	107735,6	65001,8
	600,0	158177,9	145459,0	247309,4	156534,3	145459,0	150806,1	155139,3	93602,6
	700,0	215297,7	197985,8	336615,6	213060,5	197985,8	205263,8	211161,8	127403,5
12"	800,0	281205,2	258593,7	439661,2	278283,1	258593,7	268099,7	275803,2	166404,6
	900,0	355900,4	327282,7	556446,2	352202,1	327282,7	339313,7	349063,4	210605,9
	1000,0	439383,1	404052,7	686970,6	434817,4	404052,7	418905,8	430942,5	260007,2

²⁾ Referred to DIN 1945 / ISO 1217 (20°C, 1000mbar) and compressed air.

³⁾ Referred to DIN 1343: 0°C, 1013,25 mbar

4.2.4 Measuring range „High Speed Version“

Innerdiameter of pipe		High Speed Version (224,0 m/s)							
		Full scale value in in Nm ³ /h							
Inch	mm	Air ²⁾	Air ³⁾	Ar ³⁾	CO ₂ ³⁾	N ₂ ³⁾	O ₂ ³⁾	N ₂ O ³⁾	Methane ³⁾ Natural gas ³⁾
1/2"	16,1	110,2	101,3	172,2	109,0	101,3	105,0	108,0	65,2
3/4"	21,7	215,3	198,0	336,7	213,1	198,0	205,3	211,2	127,4
1"	25,0	295,3	271,6	461,7	292,2	271,6	281,5	289,6	174,7
	26,0	321,1	295,3	502,0	317,8	295,3	306,1	314,9	190,0
	27,3	356,9	328,2	557,9	353,1	328,2	340,2	350,0	211,2
	28,5	391,5	360,0	612,1	387,4	360,0	373,2	384,0	231,7
	30,0	437,2	402,0	683,6	432,7	402,0	416,8	428,8	258,7
1 1/4"	32,8	528,7	486,2	826,7	523,3	486,2	504,1	518,6	312,9
	36,0	643,5	591,8	1006,1	636,8	591,8	613,5	631,2	380,8
	36,3	655,1	602,4	1024,3	648,3	602,4	624,6	642,5	387,7
1 1/2"	39,3	774,7	712,4	1211,3	766,7	712,4	738,6	759,8	458,5
	40,0	803,6	739,0	1256,4	795,2	739,0	766,1	788,2	475,5
	41,9	882,0	811,0	1378,9	872,8	811,0	840,9	865,0	521,9
	43,1	941,2	865,5	1471,6	931,4	865,5	897,3	923,1	557,0
	45,8	1068,1	982,2	1670,0	1057,0	982,3	1018,4	1047,6	632,1
2"	50,0	1282,5	1179,4	2005,2	1269,2	1179,4	1222,8	1257,9	758,9
	51,2	1346,5	1238,2	2105,2	1332,5	1238,2	1283,7	1320,6	796,8
	53,1	1450,1	1333,5	2267,1	1435,0	1333,5	1382,5	1422,2	858,1
	54,5	1529,4	1406,4	2391,2	1513,5	1406,4	1458,1	1500,0	905,0
	57,5	1806,1	1660,8	2823,8	1787,3	1660,8	1721,9	1771,4	1068,8
	60,0	1869,6	1719,3	2923,2	1850,2	1719,3	1782,5	1833,7	1106,4
	64,2	2148,4	1975,6	3359,0	2126,1	1975,6	2048,3	2107,1	1271,3

²⁾ Referred to DIN 1945 / ISO 1217 (20°C, 1000mbar) and compressed air.

³⁾ Referred to DIN 1343: 0°C, 1013,25 mbar

Innerdiameter of pipe		High Speed Version (224,0 m/s)							
		Full scale value in in Nm ³ /h							
Inch	mm	Air ²⁾	Air ³⁾	Ar ³⁾	CO ₂ ³⁾	N ₂ ³⁾	O ₂ ³⁾	N ₂ O ³⁾	Methane ³⁾ Natural gas ³⁾
2 1/2"	65,0	2204,9	2027,6	3447,4	2182,0	2027,6	2102,2	2162,6	1304,8
	70,3	2588,6	2380,4	4047,2	2561,7	2380,4	2467,9	2538,8	1531,8
	71,1	2647,8	2434,9	4139,8	2620,3	2434,9	2524,4	2596,9	1566,8
	76,1	3040,6	2796,1	4754,0	3009,0	2796,1	2898,9	2982,2	1799,3
3"	80,0	3368,4	3097,5	5266,4	3333,4	3097,5	3211,4	3303,7	1993,3
	82,5	3582,2	3294,2	5600,7	3545,0	3294,2	3415,2	3513,4	2119,8
	84,9	3793,6	3488,6	5931,3	3754,2	3488,6	3616,8	3720,8	2244,9
	90,0	4268,2	3925,0	6673,3	4223,9	3925,0	4069,3	4186,2	2525,8
4"	100,0	5275,8	4851,5	8248,6	5220,9	4851,6	5029,9	5174,4	3122,0
	107,1	6058,8	5571,6	9472,8	5995,8	5571,6	5776,4	5942,4	3585,3
	110,0	6391,3	5877,4	9992,8	6324,9	5877,4	6093,5	6268,6	3782,1
	125,0	8263,2	7598,7	12919,4	8177,3	7598,8	7878,1	8104,4	4889,8
5"	133,7	9453,4	8693,3	14780,3	9355,2	8693,3	9012,9	9271,8	5594,1
	150,0	11913,2	10955,3	18626,2	11789,4	10955,3	11358,0	11684,4	7049,7
	159,3	13436,3	12355,9	21007,4	13296,6	12355,9	12810,1	13178,1	7951,0
	182,5	17656,0	16236,3	27604,9	17472,5	16236,3	16833,1	17316,8	10448,0
6"	190,0	19137,0	17598,2	29920,4	18938,1	17598,2	18245,1	18769,3	11324,4
	200,0	21229,7	19522,7	33192,4	21009,1	19522,7	20240,3	20821,9	12562,8
	206,5	22632,1	20812,3	35385,0	22396,9	20812,3	21577,3	22197,3	13392,6
	250,0	33211,0	30540,6	51925,1	32865,9	30540,6	31663,2	32573,0	19652,8
10"	260,4	36074,6	33173,9	56402,2	35699,7	33174,0	34393,4	35381,6	21347,3
	300,0	47880,9	44030,8	74861,2	47383,3	44030,9	45649,4	46961,1	28333,8
	309,7	51027,2	46924,2	79780,5	50497,0	46924,3	48649,1	50047,0	30195,6
	339,6	61355,7	56422,1	95929,0	60718,1	56422,3	58496,2	60177,1	36307,5
12"	400,0	85121,6	78277,0	133086,6	84237,0	78277,2	81154,5	83486,4	50371,1
	500,0	133002,5	122307,8	207947,8	131620,4	122308,1	126803,9	130447,5	78704,9
	600,0	191523,6	176123,3	299444,9	189533,3	176123,7	182597,6	187844,3	113335,0
	700,0	260684,8	239723,3	407577,7	257975,9	239724,0	248535,6	255677,0	154261,5
	800,0	340486,3	313108,0	532346,4	336948,1	313108,8	324618,0	333945,5	201484,4
	900,0	430928,0	396277,3	673750,9	426450,0	396278,4	410844,6	422649,7	255003,8
	1000,0	532009,9	489231,3	831791,3	526481,5	489232,6	507215,6	521789,8	314819,5

²⁾ Referred to DIN 1945 / ISO 1217 (20°C, 1000mbar) and compressed air.

³⁾ Referred to DIN 1343: 0°C, 1013,25 mbar

5 Dimensions

5.1 Dimension IVA
550

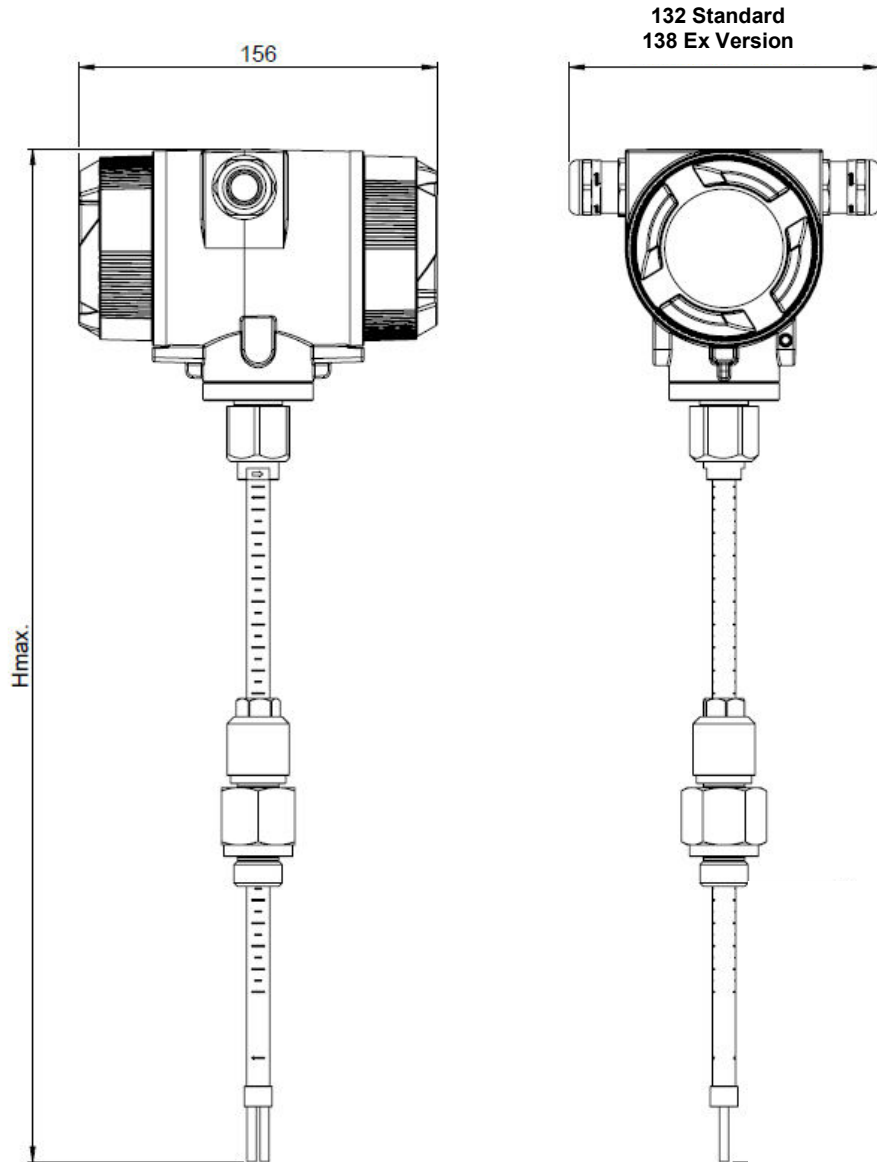

Sensor lenght	H [mm]	Scaling [mm]
C1	441	220
C2	521	300
C3	621	400
C4	721	500
C5	821	600
C7	381	160

6 Installation

6.1 Pipe/tube requirements

- Correctly sized gaskets
- Correct aligned flanges and gaskets
- Diameter mismatch at the pipe junctions should be avoided but must be less than 1mm. For further information see ISO 14511
- Ensure clean pipes after installation

6.2 Inlet / outlet runs

The principle of thermal Mass flow measurement is very sensitive against disturbances. Therefore, it is necessary to ensure the recommended inlet and outlet runs.

Table Inlet / Outlet runs

Flow obstruction before the measurement section	Min length Inlet run (L1)	Min length Outlet run (L2)
Slight curve (ellbow < 90°)	12 x D	5 x D
Reduction (Pipe narrows to the measurement section)	15 x D	5 x D
Expansion (Pipe expands to the measurement section)	15 x D	5 x D
90° ellbow or T-piece	15 x D	5 x D
2x ellbow á 90° in einer Ebene	20 x D	5 x D
2x ellbow á 90° 3-dimensional	35 x D	5 x D
Control valve	45 x D	5 x D

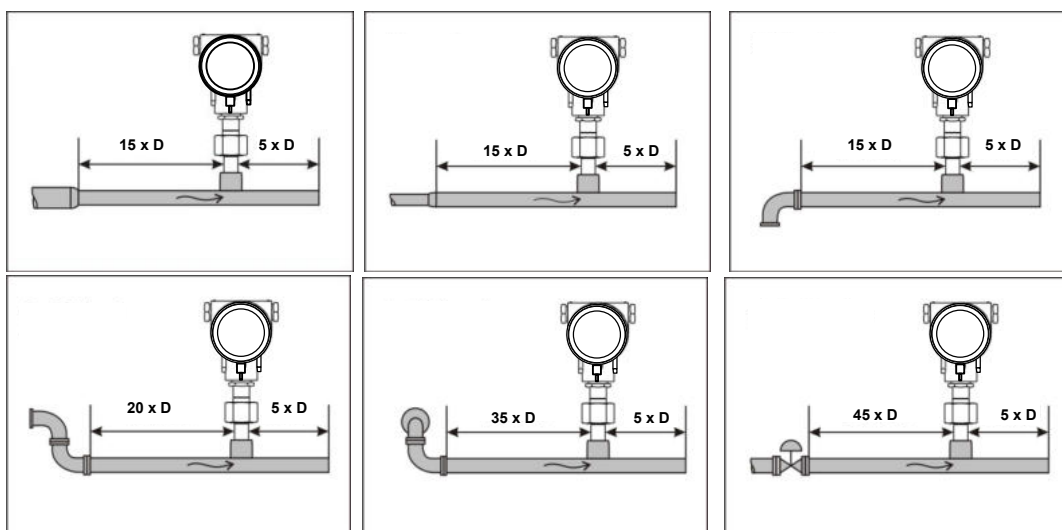

The values represent the min. lengths. In case the min. inlet / outlet runs could not be ensured, it must be expected to get increased or significant deviations of the measurement values.

6.3 Installation IVA 550

The installation of the sensor is done via a ball valve 1/2".

If no valid measuring point with a ball valve 1/2" is available there are following ways to set up a measuring point.



When using the consumption sensor in systems with working pressure > 10 bar, for safety reasons the use of a high pressure protection is required.

6.3.1 1/2" welded nipple with ball valve 1/2"



Important:

Ensure that the system is in shut down, i.e. depressurized.

Note for installation with ball valve

Ball valve R 1/2", DN 15

Passage ball valve: Minimum Ø15 mm

6.3.2 Spot drilling collar with ball valve



In case the system could not be shut down, means to be set depressurized, there could be used the spot drilling collar (Order-No. 0530 1108) and drilling jig (Order-No. 0530 1108) to drill through the ball valve.

6.4 Installation of the Sensor

6.4.1 Mounting IVA 550 onto the ball valve

- Assembly is carried out by inserting the connection thread with gasket. (G1/2" thread, SW 32) into the connection piece (ball valve). The sensor has to be tightened by hand as far as possible and then tightened with stipulated torque of 25-30 Nm. It must be ensured that the installation is pressure-tight.



- The sensor is then inserted to the required immersion depth and aligned according to the direction of the airflow. A depth scale engraved on the probe tube, a flow alignment arrow and an aligning device will be of help for you. Once the sensor has been aligned the adapter sleeve must be tightened with stipulated torque of 20-30Nm (SW 17).

Attention: Alignment of the sensor must not be modified when tightening the connection thread and adapter sleeve. In this case, please check the immersion depth and alignment again and correct it if necessary. The angular deviation should not be greater than $\pm 2^\circ$ in relation to ideal position as otherwise the measuring accuracy will decrease.

Calculation mounting depth:

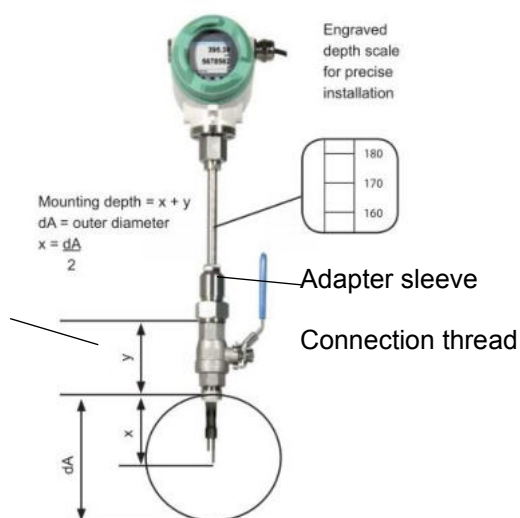

Alignment



Sensor alignment

A max. angle deviation of $\pm 2^\circ$ is permitted to ensure correct measured values.

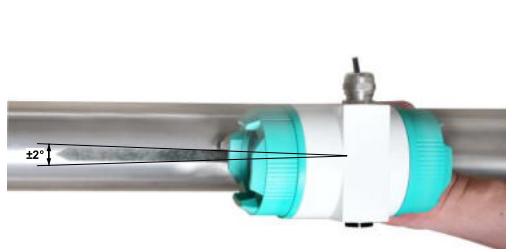

6.5 Alignment Display (Housing)

The sensor housing IVA 550 can be turned in both directions, max. 345 °. For this purpose, the housing-connecting nut must be opened. The housing can be rotated to the desired position, a bigger rotation angle is prevented by internal stop pins.

After that, the housing-connecting nut is firmly retighten

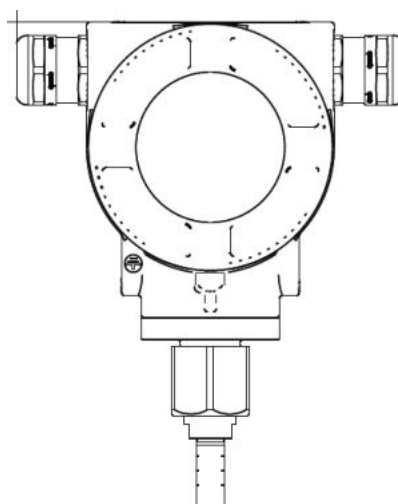
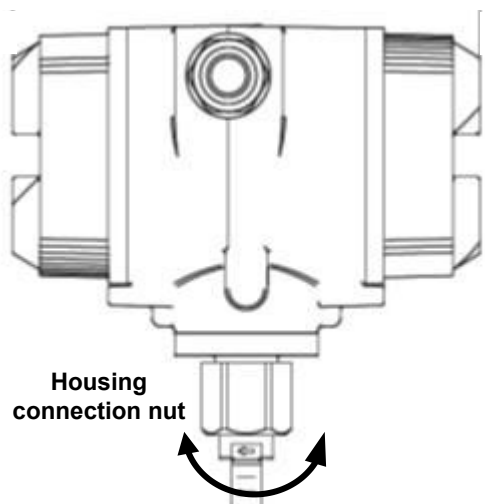

The housing-connecting nut must not be completely unscrewed / opened, please only open it for one or two turns.

6.6 Tightening torques

To secure and guarantee of the function and tightness following tightening torques have to be applied, see table 1.

Table 1

Pos	Description	Tightening torque [Nm]
20	IVA 550 Cover with glass	3
30	IVA 550 Cover closed	3
50	Grub screw with hexagon socket M4x6 DIN 914 A2	2
130	IVA 550 Nut	15
150	Cylinder head screw DIN 6912 - M5x10 A2-70	4
240	V-MS-Ex-d 1 875 2000 50 2 03	8
250	RN16M20KNP	8

7 Connection diagram

7.1 Cable glands - clamping ranges

For ensuring the tightness and strain relief, connector cables with the following diameters must be used.

VA550 Standard clamping range : Ø 5- 9mm

VA550 Ex clamping range : Ø5-10mm

7.2 Connector pin assignment

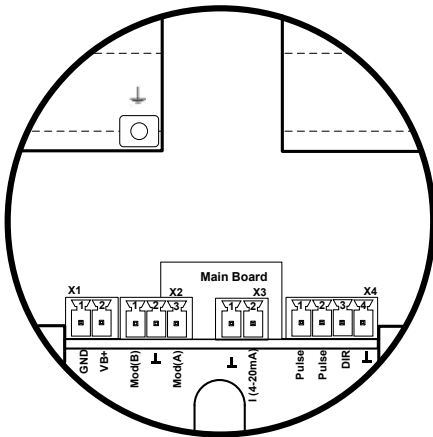

Standard version with 1x analogue output (not galvanically isolated)

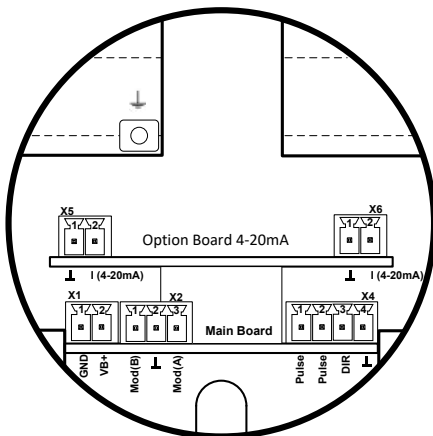

Version with option board 2x analogue outputs galvanically isolated

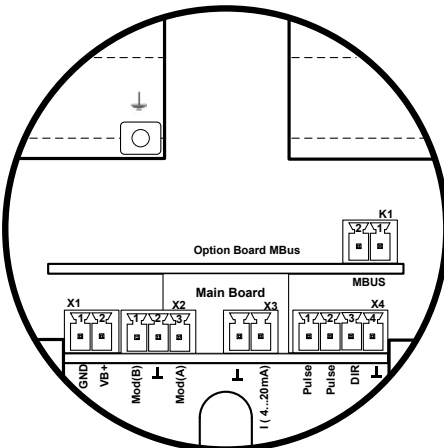

Version with option board MBus

Connector	Pin	Signal Description
X1 Power supply	1	VB - (GND)
	2	VB+
X2 Modbus	1	Modbus (B)
	2	Modbus shield
	3	Modbus (A)
X3 current output	1	I- Active
	2	I+ Active
X4 Direction / Pulse	1	Pulse / Alarm *
	2	Pulse / Alarm *
	3	Direction input
	4	GND
X5 Current output 1	1	I- Active**
	2	I+ Active **
X6 Current output 2	1	I- Active **
	2	I+ Active **
K1 Mbus	1	Mbus
	2	Mbus

* Outputs are galvanically isolated.

** The Current outputs, X5 and X6, are optional.(Active and passive version available).

7.3 Wire connection

7.3.1 General:

- Wiring to be done in strainless state only.
- Length of cable skinning to be minimized
- Not used cable entries must be closed with end caps
- Use of cables with cross section of $\geq 0.25\text{mm}^2$

7.3.2 Power supply

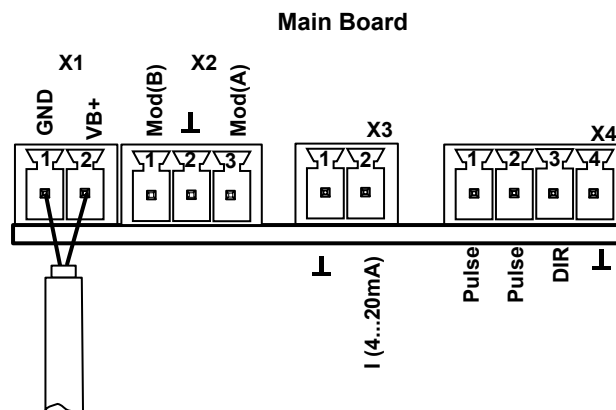

7.3.3 Modbus RTU:

If the sensor placed at the end of the Modbus system a termination is required.

Therefore, the enclosed 120R resistor is to be connected at Pin 1 and Pin 3 of connector „X2“

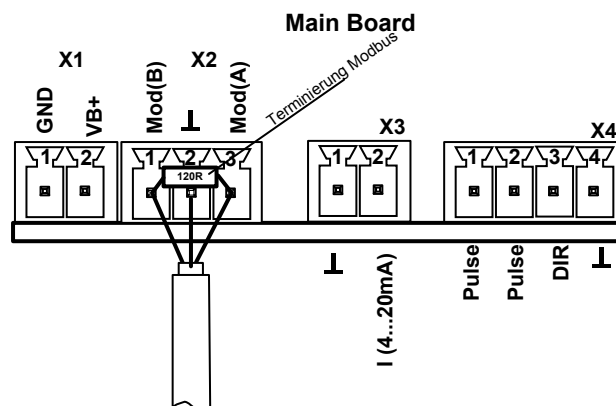

7.3.4 Modbus TCP (Ethernet) Optional PoE

M12 x-coded

Data LINES: 1,2 und 3,4

PoE LINES: 5,6 und 7,8

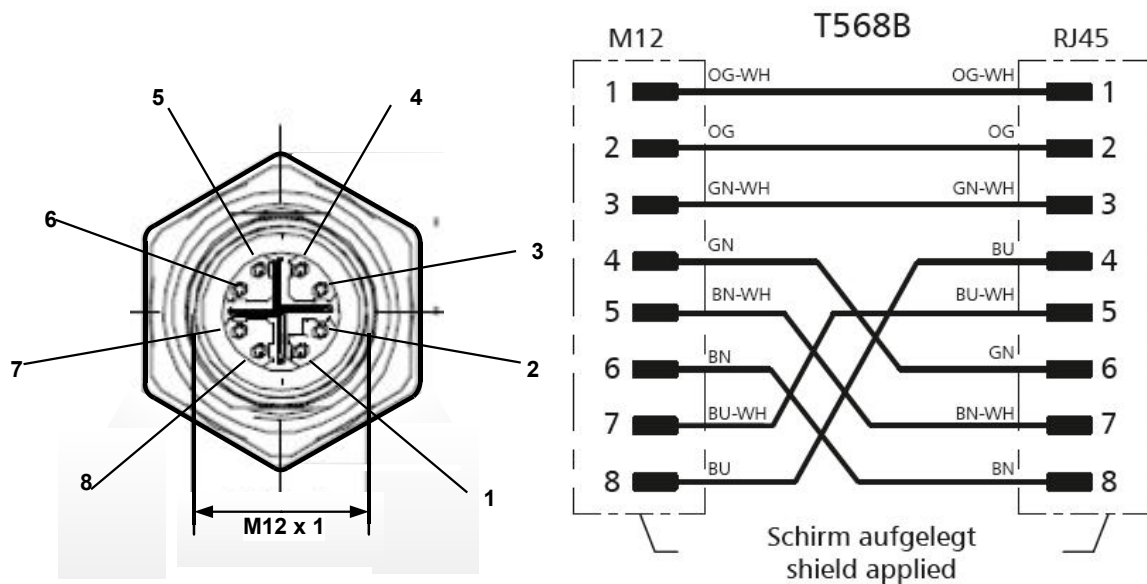

Connection cable: Cat 6.

*PoE: Power over Ethernet

7.3.5 Pulse Output

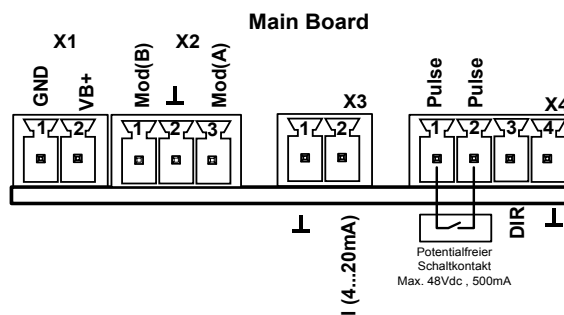

8 Operation IVA 550

Remark: In version with display only

The operation of the IVA 550 are carried out by 2 optical keys through the glass cover Thus, the IVA 550 can be operated from the outside without opening the cap.

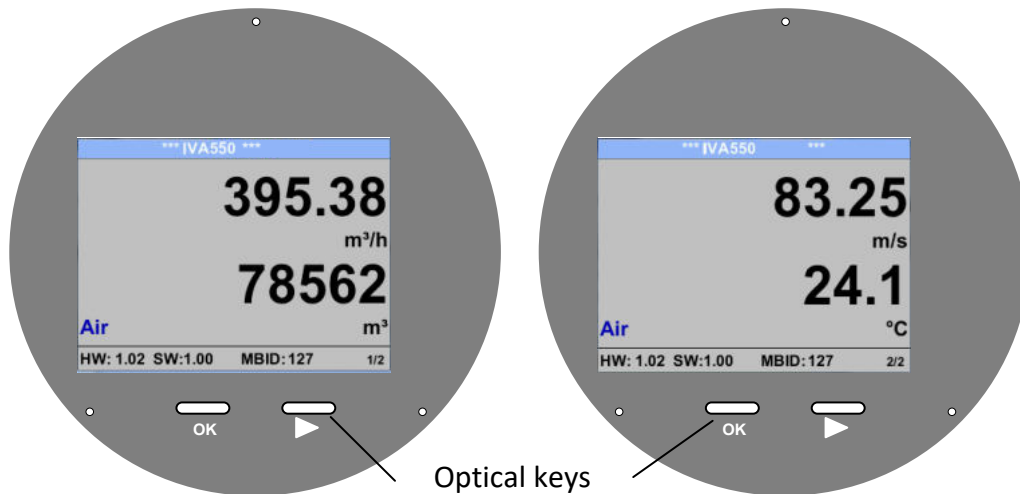

Selection of the individual menu items is done by pressing the ">" and confirm by pressing "OK".

Inputs or changes can be made with all white deposit fields, selcted filed will be highlighted with yellow background.

Words in **green font** refer mainly to the pictures in the section of the chapter, but also on important menu paths or menu items that are related to are in **green font**.

The menu navigation is generally in a **green font**!

The table of contents and chapter references in **blue font** contain links to the respective chapter title.

8.1 Main menu (Home)

8.1.1 Initialization

After switching on the IVA 550 the initialized screen is displayed followed by the main menu.

8.2 Main menu

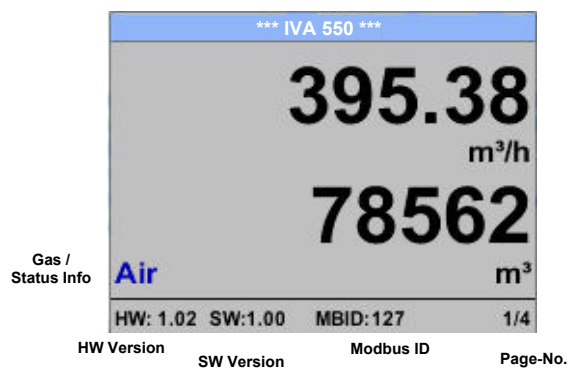

Switching to pages 2-4 or back by pressing key „>“

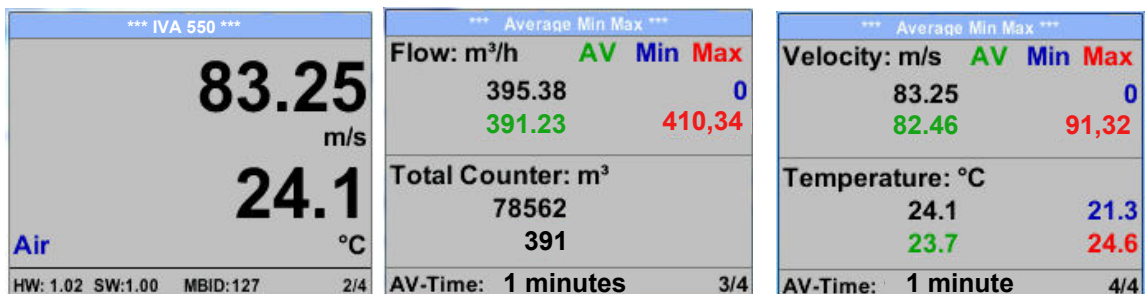

AV-Time (Period for average value calculation) could be changed under *Sensor Setup.-Advanced- AV-Time*

8.3 Settings

The settings menu could accessed by pressing the key „OK“. But the access to the *settings menu* is password protected.



Factory settings for password at the time of delivery: 0000 (4 times zero).
If required the password could be changed at *Setup–User setup-Password*.

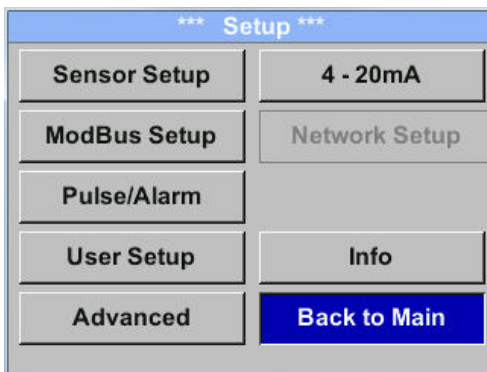

Selection of a menu item or to change a value is done with the key „>“, a final move to the chosen menu item or takeover of the value change needs the confirmation by pressing the key „OK“

8.3.1 Sensor Setup

Setup → Sensor Setup

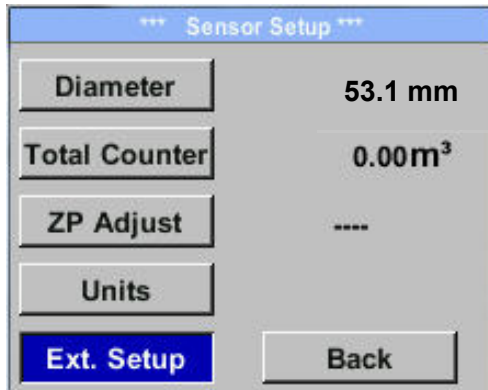

For changes, first select the menu item with key „>“ and then confirm it with **“OK”**.

8.3.1.1 Input / change tube diameter

Settings → Sensor Setup → Diameter

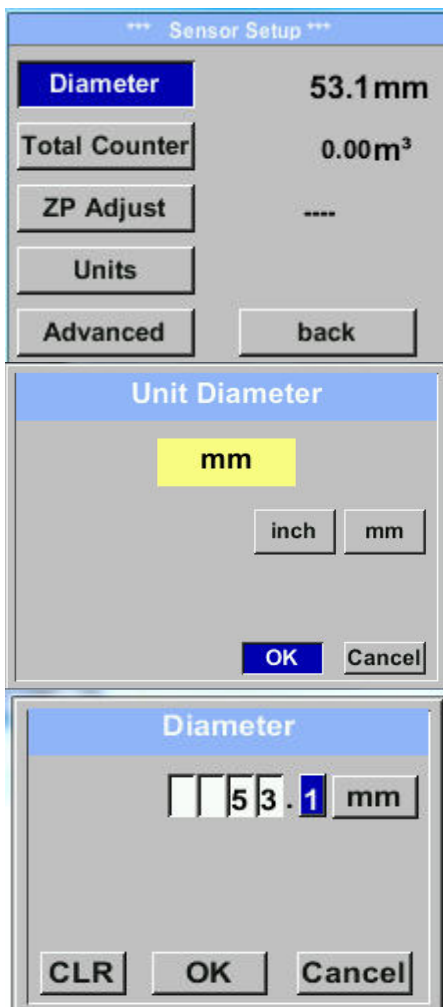

In order to change, e.g. the unit, first select by pressing key „>“ the field **“Units”** and then key **“OK”**.

Select with the key „>“ the correct unit and then confirm selection by pressing 2x **„OK”**.

Entering / changing the diameter via button „>“, select the respective position and activate the position with the **“OK”** button. By pressing „>“ the position value is incremented by 1. Complete with **“OK”** and activate next number position. Confirming entry by pressing **„OK”**.

8.3.1.2 Input / change consumption counter

Setup → Sensor Setup → Total Counter → Unit button

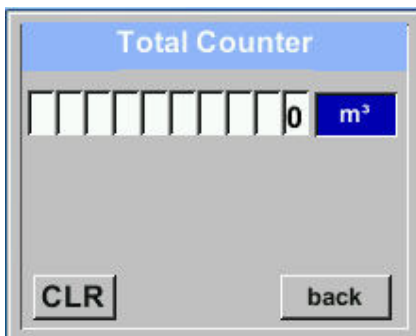
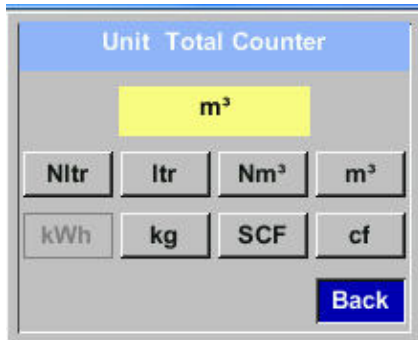

In order to change, e.g. the unit, first select by pressing key „>“ the button **“Unit”** and then key **“OK”**.

Select with the key „>“ the correct unit and then confirm selection by pressing 2x **„OK”**.

Entering / changing the consumption counter via button „>“, select the respective position and activate the position with the **“OK”** button. By pressing „>“ the position value is incremented by 1. Complete with **“OK”** and activate next number position.

Confirm entry by pressing **„OK”**.

Important!

When the counter reach 100000000 m³ the counter will be reset to zero.

8.3.1.3 Definition of the units for flow, velocity, temperature and pressure

Setup → Sensor Setup → Units

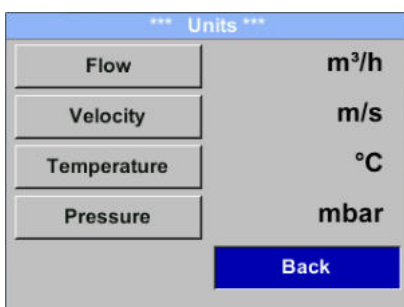

To make changes to the unit for the respective measurement value, first select by pressing „>“ the field of the „measurement value“ and activate „it with **„OK”** .

Selection of the new unit with „>“

In case the quantity of units selectable are not presentable on one page, pleas move to next page by pressing **„<<”**.

Confirm selection by pressing 2x **„OK”**.

Procedure for all 4 measurement-variables is analogous.

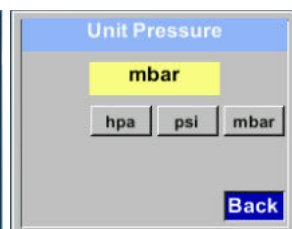
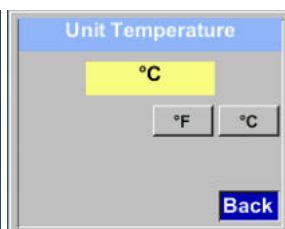
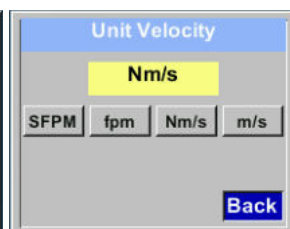
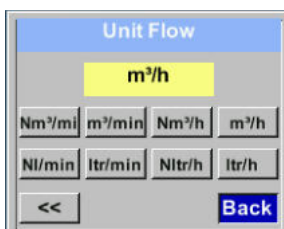

8.3.1.4 Definition of the reference conditions

Here can be defined the desired measured media reference conditions for pressure and temperature and times for the filter and averaging.

- Factory pre-setting for reference temperature and reference pressure are 20 °C, 1000 hPa
- All volume flow values (m³/h) and consumption values indicated in the display are related to 20 °C and 1000 hPa (according to ISO 1217 intake condition)
- Alternatively 0 °C and 1013 hPa (=standard cubic meter) can also be entered as a reference.
- **Do not enter the operation pressure or the operation temperature under reference conditions!**

Setup → Sensor Setup → Advanced

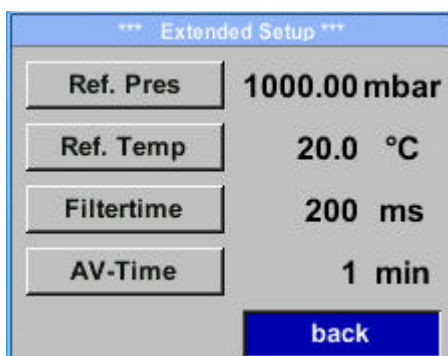

To make changes, first select a menu with button „>“ and confirm selection by pressing „OK“ .

Setup → Sensor Setup → Advanced → Ref.Pref



In order to change, e.g. the unit, first select by pressing key „>“ the field **“Units”** and then key **“OK”**.

Select with the key „>“ the correct unit and then confirm selection by pressing 2x **„OK“**.

Input / change of the value by selecting the respective position with button „>“ and entering by pressing button **„OK“** .

Setup → Sensor Setup → Advanced → Ref.Temp

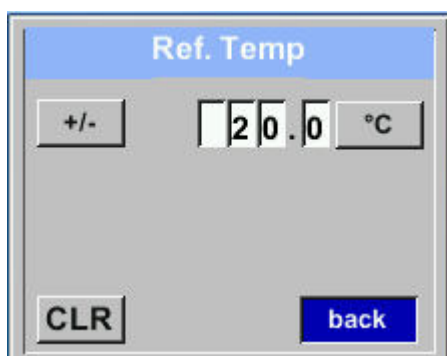

By pressing „>“ the position value is incremented by 1. Complete with **“OK”** and activate next number position.

Procedure for changing the reference temperature is the same.

Setup → Sensor Setup → Advanced → Filtertime

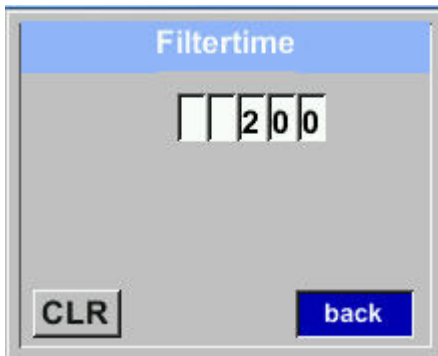

Under item **"Filtertime"** an attenuation can be defined.
Input values of 0 -10000 in [ms] are possible

Setup → Sensor Setup → Advanced → AV-Time

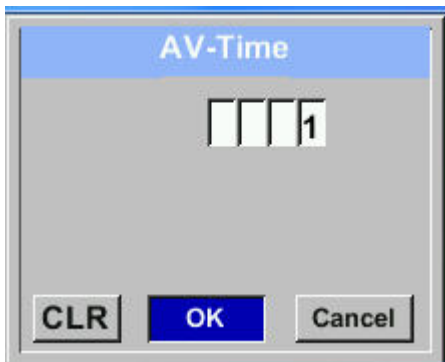

The time period for averaging can be entered here.
Input values of -1440 1 [minutes] are possible.
For average values, see display window 3 + 4

8.3.1.5 Setting of Zeropoint and Low-flow cut off

Setup → Sensor Setup → ZP Adjust

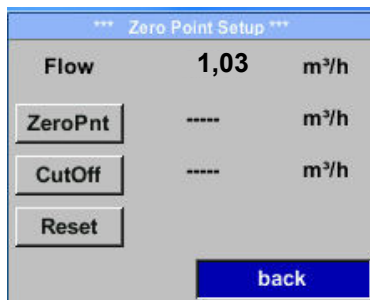

To make changes, first select a menu with button „>“ and confirm selection by pressing „OK“ .

Setup → Sensor Setup → ZP Adjust → ZeroPnt

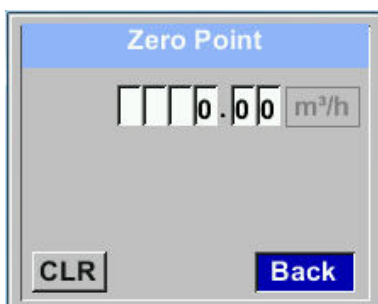

When, without flow, the installed sensor shows already a flow value of > 0 m³/h herewith the zero point of the characteristic could be reset.

For an input / change of the value select with the button „>“ the respective number position and activate it with „OK“ .

By pressing „>“ the position value is incremented by 1. Confirm the input with „OK“ and activate next number position.

Leave menu with button „Back“

Setup → Sensor Setup → ZP Adjust → CutOff

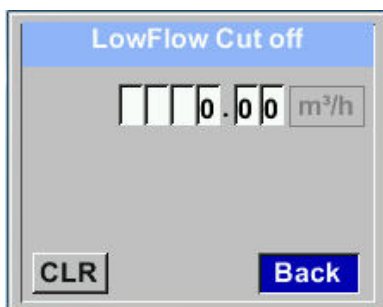

With the low-flow cut off activated, the flow below the defined "LowFlow Cut off" value will be displayed as 0 m³/h and not added to the consumption counter.

For an input / change of the value select with the button „>“ the respective number position and activate it with „OK“ .

By pressing „>“ the position value is incremented by 1. Confirm the input with „OK“ and activate next number position.

Leave menu with button „Back“

Setup → Sensor Setup → ZP Adjust t → Reset

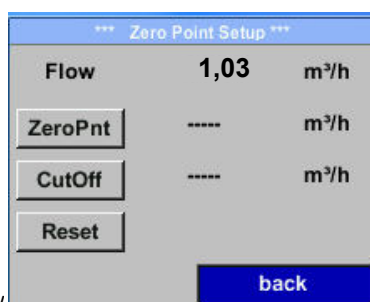

By selection of „Reset“ all settings for „ZeroPnt“ and „CutOff“ are reset.

Menu item to be select with button „>“ and confirm the reset with „OK“ .

Leave menu with button „Back“

8.3.2 Modbus RTU

8.3.2.1 Setup

The Flow sensors IVA 550 comes with a Modbus RTU Interface. Before commissioning the sensor the communication parameters

- Modbus ID, Baud rate, Parity und Stop bit

must be set in order to ensure the communication with the Modbus master.

Settings → Modbus Setup

*** ModBus Setup ***

ID	1	Baudrate	19200
Stop	1	Parity	even
Byte Order	ABCD		

Set to Default back

ID

2

CLR OK Cancel

*** ModBus Setup ***

ID	2	Baudrate	19200
Stop	1	Parity	even
Byte Order	ABCD		

Set to Default Save Cancel

For changes, e.g. the sensor ID, first select by pressing key „>“ the field “ID” and then key “OK”.

Select the desired position by pressing the “>” and select with “OK” button.

Change values by pressing the „>“ values takeover by pressing “OK”.

Inputs for baudrate, stopbit and parity is done analogue.

By means of the button "Byte Order" it is possible to change the data format (Word Order). Possible formats are "ABCD" (Little Endian) and "CDAB" (Middle Endian)

Saving the changes by pressing “Save”, therefore select it with key „>“ and then confirm it with “OK”.

Reset to the default settings by activating “Set to Default”-

Default values out of factory:

Modbus ID:	1
Baud rate:	19200
Stopbit:	1
Parity:	even
Byte Order:	ABCD

Remark: If the sensor placed at the end of the Modbus system, a termination is required.

Therefore, the enclosed 120R resistor is to be connected at Pin 1 and Pin 3 of connector „X2“

8.3.3 Modbus TCP (Optional)

8.3.3.1 Setup

The Flow sensors IVA 550 comes optional with a Modbus TCP Interface (HW Interface:M12 x 1 X-coded connector).

Device supports with this option the Modbus TCP protocol for communication with SCADA systems. TCP port is set to 502 by default. Port can be changed at the sensor or using PC Service Software

Modbus device address (Unit Identifier) can be set in the range of 1- 255.

Specification and description of the Modbus protocol is free to download on: www.modbus.org.

Supported Modbus commands (functions):

Command	Code	Description
Function Code	3	(Read holding register)
Function code	16	(Write multiple registers)

For more details, please see **IVA 5xx Modbus RTU_TCP Installation**

V1.04 *Settings* → *Network Setup*

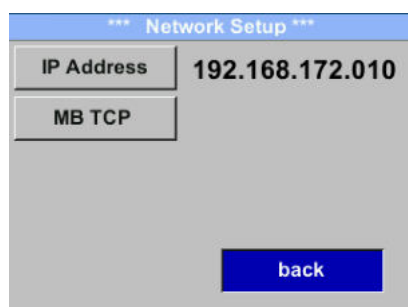

8.3.3.1.1 *Network Setup DHCP*

Settings → *Network Setup Settings* → *IP Address*

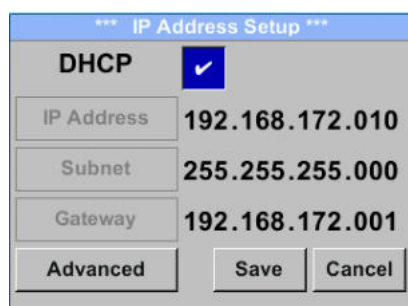

Here you can set up and made a connection, with or without *DHCP*, to a computer.

Remark:

With activated *DHCP* the automatic integration of the sensor in an existing network is possible, without a manual configuration.

Storing of settings by pressing “*Save*”

8.3.3.1.2 Network Settings static IP

Settings → Network Setup Settings → IP Address → IP Address

Settings → Network Setup Settings → IP Address → Sub Netz

Settings → Network Setup Settings → IP Address → Gateway

*** IP Address Setup ***

DHCP

IP Address 192.168.172.010

Subnet 255.255.255.000

Gateway 192.168.172.001

Advanced back

*** IP Address Setup ***

DHCP

IP Address 192.168.172.010

Subnet 255.255.255.000

Gateway 192.168.172.001

Advanced back

IP Setup

1 9 2

CLR back

Subnet Setup

2 5 5

CLR back

Gateway Setup

1 9 2

CLR back

*** IP Address Setup ***

DHCP

IP Address 192.168.172.011

Subnet 255.255.255.000

Gateway 192.168.172.001

Advanced Save Cancel

For manual (static) IP, the "IP Address", "Subnet" and "Gateway" selection keys must be selected and activated with "OK".

The first data field of the selection, in this case the IP address, is then marked (red).

Confirm with "OK" the corresponding input menu is opened.

By means of ">", the next data field is changed.

Select the desired position with the ">" key and activate it with the "OK" key.

Change the values with the ">" key, and accept the values with the "OK" key.

Procedure for "Subnet" and "Gateway" is analogous.

Store the settings by „Save“

8.3.3.1.3 Modbus TCP Settings

Settings → Network Setup Settings → IP Address → MB TCP

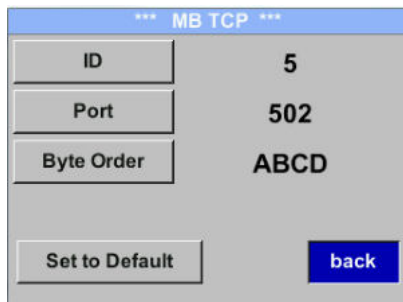

Settings → Network Setup Settings → IP Address → ID

Settings → Network Setup Settings → IP Address → Port

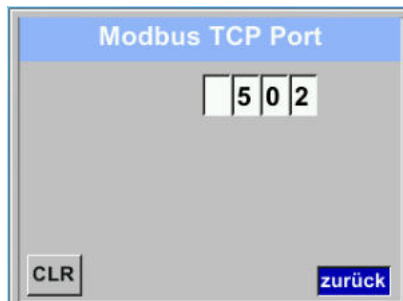
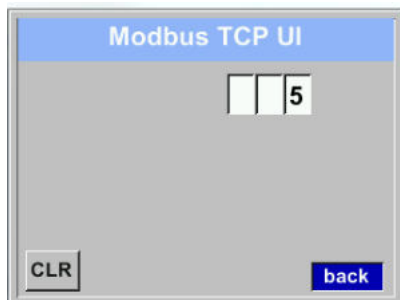

For changes, e.g. the sensor ID, first select by pressing key „>“ the field “ID” and then key “OK”.

Select the desired position by pressing the “>” and select with “OK” button.

Change values by pressing the „>“ values takeover by pressing “OK”.

Input for the port is done analogue.

By means of the button “Byte Format” it is possible to change the data format (Word Order). Possible formats are “ABCD” (Little Endian) and “CDAB” (Middle Endian)

Saving the changes by pressing “Save”, therefore select it with key „>“ and then confirm it with “OK”.

Reset to the default settings by activating “Set to Default”-

8.3.3.2 Modbus Settings (2001...2005)

Modbus Register	Register Address	No.of Byte	Data Type	Description	Default Setting	Read Write	Unit /Comment
2001	2000	2	UInt16	Modbus ID	1	R/W	Modbus ID 1...247
2002	2001	2	UInt16	Baudrate	4	R/W	0 = 1200 1 = 2400 2 = 4800 3 = 9600 4 = 19200 5 = 38400
2003	2002	2	UInt16	Parity	1	R/W	0 = none 1 = even 2 = odd
2004	2003	2	UInt16	Number of Stopbits		R/W	0 = 1 Stop Bit 1 = 2 Stop Bit
2005	2004	2	UInt16	Word Order	0xABCD	R/W	0xABCD = Big Endian 0xCDAB = Middle Endian

8.3.3.3 Values Register (1001 ...1500)

Modbus Register	Register Address	No.of Byte	Data Type	Description	Default	Read Write	Unit /Comment
1101	1100	4	Float	Flow in m ³ /h		R	
1109	1108	4	Float	Flow in Nm ³ /h		R	
1117	1116	4	Float	Flow in m ³ /min		R	
1125	1124	4	Float	Flow in Nm ³ /min		R	
1133	1132	4	Float	Flow in ltr/h		R	
1141	1140	4	Float	Flow in Nltr/h		R	
1149	1148	4	Float	Flow in ltr/min		R	
1157	1156	4	Float	Flow in Nltr/min		R	
1165	1164	4	Float	Flow in ltr/s		R	
1173	1172	4	Float	Flow in Nltr/s		R	
1181	1180	4	Float	Flow in cfm		R	
1189	1188	4	Float	Flow in Ncfm		R	
1197	1196	4	Float	Flow in kg/h		R	
1205	1204	4	Float	Flow in kg/min		R	
1213	1212	4	Float	Flow in kg/s		R	
1221	1220	4	Float	Flow in kW		R	

Modbus Register	Register Address	No.of Byte	Data Type	Description	Default	Read Write	Unit /Comment
1269	1268	4	UInt32	Consumption m ³ before comma	x	R	
1275	1274	4	UInt32	Consumption Nm ³ before comma	x	R	
1281	1280	4	UInt32	Consumption ltr before comma	x	R	
1287	1286	4	UInt32	Consumption Nltr before comma	x	R	
1293	1292	4	UInt32	Consumption cf before comma	x	R	
1299	1298	4	UInt32	Consumption Ncf before comma	x	R	
1305	1304	4	UInt32	Consumption kg before comma	x	R	
1311	1310	4	UInt32	Consumption kWh before comma	x	R	
1347	1346	4	Float	Velocity m/s			
1355	1354	4	Float	Velocity Nm/s			
1363	1362	4	Float	Velocity Ft/min			
1371	1370	4	Float	Velocity NFt/min			
1419	1418	4	Float	GasTemp °C			
1427	1426	4	Float	GasTemp °F			

Remark:

- **For DS400 / DS 500 / Handheld devices - Modbus Sensor Datatype**
„Data Type R4-32“ match with „Data Type Float“
- For more additional Modbus values please refer to VA5xx_Modbus_RTU_TCP Installation_1.04_EN.doc

8.3.4 Pulse /Alarm

Setup → Sensor Setup → Pulse/ Alarm

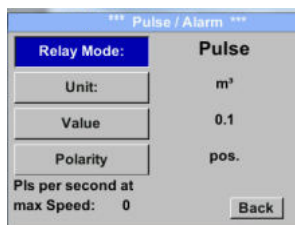
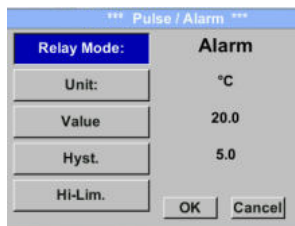
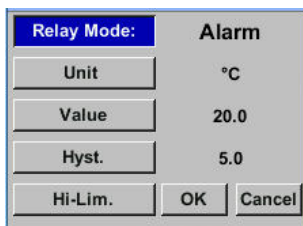

The galvanically isolated output can be defined as pulse- or alarm output. Selection of field „**Relay Mode**” with key „>” and change modus by pressing key „OK”.

For alarm output following units could be chosen: kg/min, cfm, ltr/s, m³/h, m/s, °F, °C and kg/s. „**Value**” defines the Alarm value, „**Hyst.**” defines the desired hysteresis and with „**Hi-Lim**” or „**Lo-Lim**” the alarm settings when the alarm is activated
 Hi-Lim: Value over limit
 Lo-Lim: Value under limit

For the pulse output following units could be chosen: kg, cf, ltr and m³. The pulse value definition to be done in menu „**Value**”. Lowest value is depending on max. flow of sensor and the max frequency of pulse output of 50Hz.

With „**Polarity**” the switching state could be defined. Pos. = 0 → 1 neg. 1 → 0

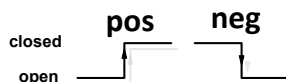

8.3.4.1 Pulse output

The maximum frequency for pulse output is 50 pulses per second (50Hz). The Pulse output is delayed by 1 second.

Pulse value	[m³ /h]	[m³ /min]	[l/min]
0.1 ltr / Pulse	18	0,3	300
1ltr / Pulse	180	3	3000
0.1m³ / Pulse	18000	300	300000
1 m³ / Pulse	180000	3000	3000000

Table 1 Maximum flow for pulse output

Entering pulse values that are not allow a presentation to the full scale value, are not allowed. Entries are discarded and error message displayed.

8.3.5 User Setup

8.3.5.1 Password

Settings → UserSetup → Password

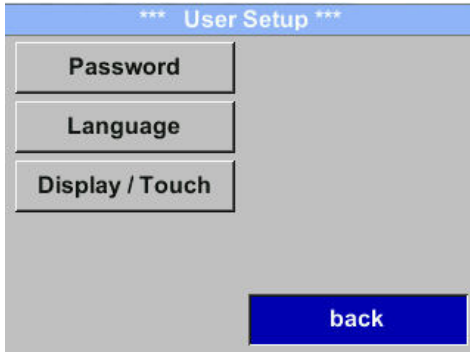

To make changes, first select a menu with button „>“ and confirm selection by pressing „OK“ .

It is possible to define a password. The required password length is 4 digits. Please select with button „>“ a figure and confirm it with „OK“ .Repeat this 4 times.

With „<“ the last figure could be deleted. Password input have to be inserted twice.

Confirmation of input/password by pressing „OK“.

Factory settings for password at the time of delivery: 0000 (4 times zero).

8.3.5.2 Language

Settings → UserSetup → Language

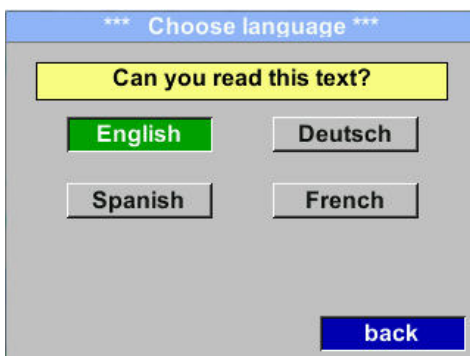

Currently 4 languages have been implemented and could be selected with button „>“.

Change of language by confirming with “OK”. Leaving the menu with button “back”.

8.3.5.3 Display / Touch

Settings → UserSetup → Display / Touch

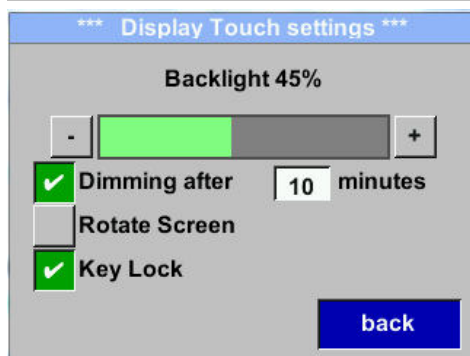
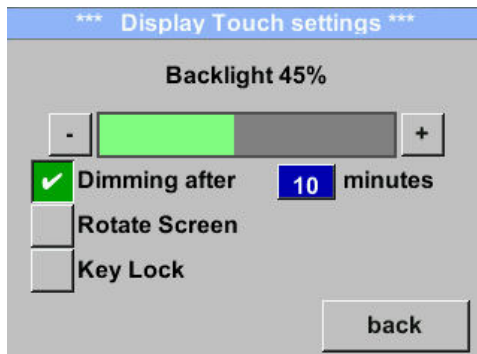

With the button „-“ and with button „+“ it is possible to adjust the backlight / display brightness. The actual / adjusted backlight brightness is showed in the graph „Backlight.“

By activation “Dimming after” and entering a time a display dimming could be set.

With „Rotate Screen“ the display information could be rotated by 180°.

By activation of „Key Lock“ the operation of the sensor locked.

Unlocking the keyboard is only possible by restarting the sensor and calling the operating menu within the first 10s. To do this, use the “OK” button to enter the operating menu during this period

8.3.6 Advanced

Settings → Advanced

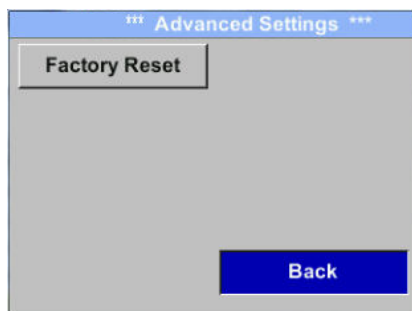

By pressing „Factory Reset“ the sensor is set back to the factory settings.

8.3.7 4 -20mA

Settings → 4-20mA

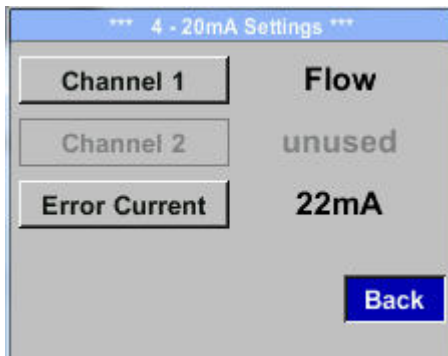

To make changes, first select a menu with button „>“ and confirm selection by pressing „OK“ .

Settings → 4-20mA → Channel 1

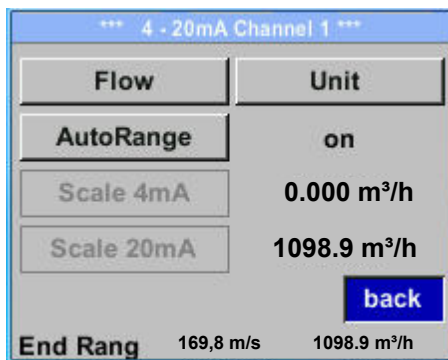

The 4-20 mA Analogue output of the Sensor IVA 550 can be individually adjusted.

It is possible to assign following values „Temperature“, „Velocity“ und „Flow“ to the channel CH 1.

To make changes, first select the value item with button „>“.and confirm Moving between the different measurements values or to deactivate the 4-20mA with setting to „unused“ by pressing „OK“.

To the selected measurement value a corresponding / appropriate unit needs to be defined. Select „Unit“ with „>“ and open menu with „OK“.

Select required unit with „>“ and take over by pressing „OK“.

Here e.g. for the measurement value Flow, procedure for the other measurements values is analog.

For saving the changes done press button „Save“ to discard the changes press button „Cancel“.

Leaving the menu with „Back“.

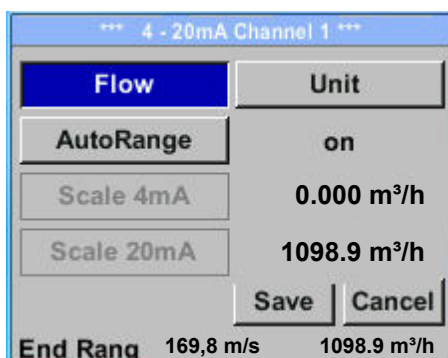
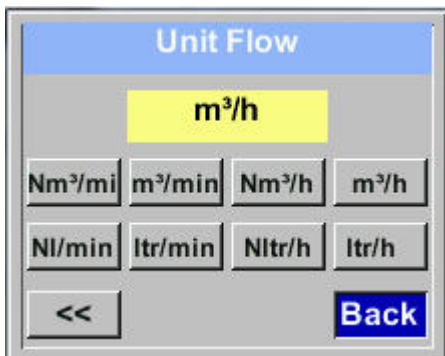

Settings → 4-20mA → Channel 1 → AutoRange

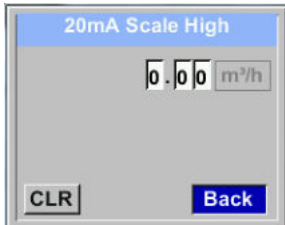
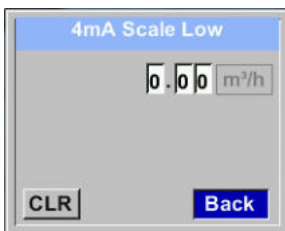
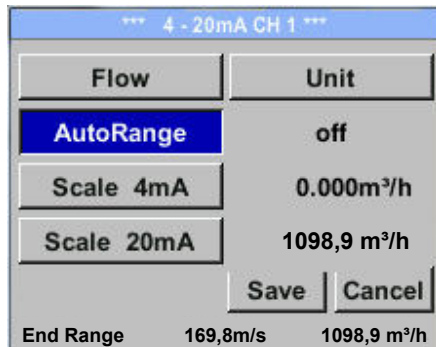

The scaling of the 4-20mA channel can be done automatically "Auto Range = on" or manual "AutoRange = off" .

With button „>“ select the menu item „AutoRange“ select with „OK“ the desired scaling method. (Automatically or manually)

In case of **AutoRange = off** with „Scale 4mA“ and „Scale 20mA“ the scale ranges needs to be defined.

Select with button „>“ the item „Scale 4mA“ or „Scale 20mA“ and confirm with „OK“ .

Input of the scaling values will be analogous as described before for value settings.

Using „CLR“ clears up the complete settings at once.

For „Auto on“ , the max. scaling is calculated based on the inner tube diameter, max. measurement range and the reference conditions settings.

Take over of the inputs with „Save“ and leaving the menu with „Back“ .

Settings → 4-20mA → Error Current

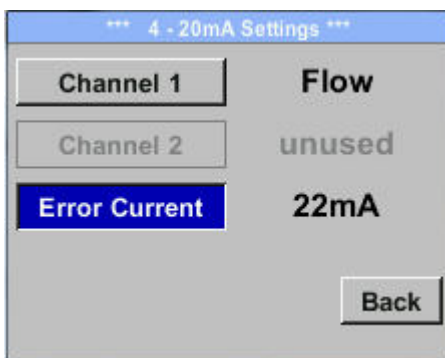

This determines what is output in case of an error at the analog output.

- 2 mA Sensor error / System error
- 22 mA Sensor error / System error
- None Output according Namur (3.8mA – 20.5 mA)
 < 4mA to 3.8 mA Measuring range under range
 >20mA to 20.5 mA Measuring range exceeding

To make changes first select a menu item "Current Error" with button „>“ and then select by pressing the „OK“ the desired mode

For saving the changes done press button „Save“ to discard the changes press button **“Cancel”**.

Leaving the menu with „Back“ .

Remark: Default setting IVA 550 for analogue output is

Default settings for VA550 with option board analogue output

For max. speed see label on Sensor.

Channel 1:0...max. speed [m/s]

Channel 1:0...max. speed [m/s]

Channel 2: -20°C ... 100°C]

8.3.8 IVA 550 Info

Setup → Sensor Setup → Info

*** Info ***	
Production Datas	
Serial No.:1234567890	Details
Cal. Date: 10.01.2013	
Sensor Datas	
Sensor Type: IST 1.8	
Max Speed: 92,7 m/s 600m ² /h	
Max Temp: 100.0 °C	
Live Datas	
Run Time: 2d 21h 23m 12s	
Vin: 23,8V Temp: 35,8	
Options	Back

*** Calibration Details ***	
Calibration Conditions	
Ref. Pressure: 1000.00mbar	
Ref. Temperature: 20 °C	
Cal. Diameter: 53,1 mm	
Cal. Pressure: 6000.00mbar	
Cal. Temperature: 23 °C	
Cal. Points: 10	
Back	

Here you get a brief description of the sensor data incl. the calibration data.

Under **Details**, you are able to see in addition the calibration conditions.

8.4 MBus

8.4.1 Change of communication settings

The communication settings Primary-address and baud rate could be changed directly at the sensor, in case sensor has a display, or with the Service software (Order-No. 0554 2007).

Settings → M-Bus

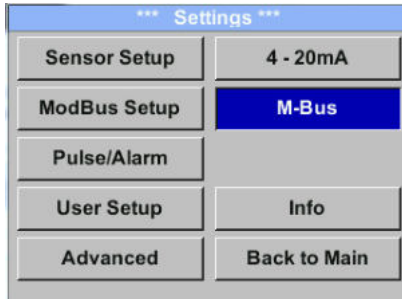

Settings → M-Bus → Adr

Possible inputs are values from 1-255 (Default setting = 1)

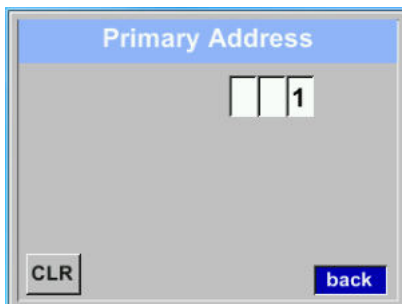
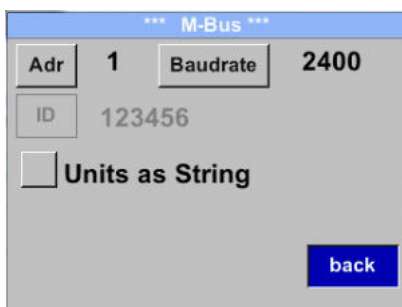

With „>“ select the button „Adr“ and confirm it with „OK“.

Select the desired position by pressing the button „△“ and select it with "OK" button.

Change values by pressing „>“ with step of 1, taking the value by confirming with "OK". Move to next position with „>“

Using „CLR“ clears up the complete settings at once.

For saving the changes done press button „Save“ to discard the changes press button "Cancel".

Leaving the menu with „Back“.

Remark: Secondary address "ID" is not changeable the ID is fixed.

Settings → M-Bus → Baudrate

Possible values are 2400, 4800 and 9600 Baud (Default setting = 2400).

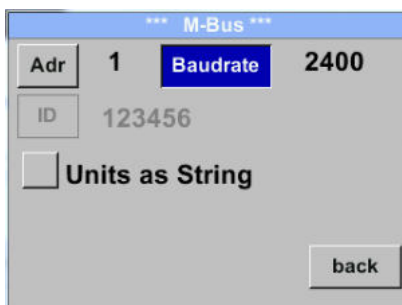

Baudrate change by pressing the button „OK“

For saving the changes done press button „Save“ to discard the changes press button "Cancel".

Leaving the menu with „Back“.

8.4.2 Coding VIF (Value Information Field)

*** M-Bus ***

Adr 1 Baudrate 2400

ID 123456

Units as String

back

*** M-Bus ***

Adr 1 Baudrate 2400

ID 123456

Units as String

Save Cancel

The Sensor offers two possibilities for coding the Value Information Field (VIF).

- Primary VIF (The units and multiplier correspond to M-Bus specification 4.8 chapter 8.4.3)
- Plain text VIF (units are transmitted as ASCII characters. So units that are not included in M-Bus specification chapter 8.4.3 are possible)

Download:

<https://m-bus.com/assets/downloads/MBDOC48.PDF>

Switch to Plain Text VIF by activation of „Units as String“.

8.4.3 Default Settings communication

Primary Address*: 1
 ID: Serial number of Sensor
 Baud rate*: 2400
 Medium*: depending on medium (Gas or Compressed Air)
 Manufacturer ID: CSI
 VIF coding: Primary VIF

Both addresses, Primary address and ID, could be searched in the M-Bus system automatically.

8.4.4 Default values transmitted

Value 1 with [Unit]*: Consumption [m³]
 Value 2 with [Unit]*: Flow [m³/h]
 Value 3 with [Unit]*: Gas temperature [°C]

*All Values could be changed / preset in production or with Service software (Order-No. 0554 2007)

9 Supplementary Documentation

- Supplementary Documentation for Ex-Version:
 Flow / Consumption Sensor IVA 550 Ex / VA5 70 Ex - Ex-
 Documentation

